



Canoes, Kayaks & Accessories

Bainbridge International Limited is a privately owned UK business operating from Hedge End in Southampton.

The company, founded in Boston US in 1917, originally started by designing and manufacturing Sailcloth from Egyptian cotton. A business at the forefront of new development, Bainbridge was the first sailcloth manufacturer to pioneer synthetic sailcloth – inventing and creating the current market over 80years ago.

Since then Bainbridge has expanded - into Sail Hardware and Marine Hardware – with the incorporation of the Aqua Marine distribution business, and developed through a range of technical application products for specific customer markets including outdoor leisure, recreation and 4x4 markets.

Today the business is still growing and is managed in a way to ensure long term, sustainable partnerships are built with customers and suppliers.

Bainbridge is delighted to announce it is now partnering with Johnson Outdoors Watercraft to provide distribution of their established leading brands to the UK & Ireland markets.

This catalogue highlights our latest range which offers real value to watercraft retailers, with the very best products and brands from around the globe.

In serving our customers new and old we are continually striving to:

- Offer improved service levels – in stock and delivery
- Make transacting with us simple and easy in the way that suits you best – dedicated b2b online ordering, customer service or direct account management
- Provide in field and internal support and service
- Help you sell more Johnson product with confidence
- Ensure that our pricing is fair and equitable
- Bring you an unrivaled range of related products and brands which offer additional sales opportunities

It is an exciting time for the business as Bainbridge continues investment with the expansion of the Hedge End distribution centre and the appointment key personnel to support the Old Town, Necky, Ocean Kayak and Carlisle brands.

Key Bainbridge Facts:

- UK Privately owned
- Managed and operated from Hedge End, Southampton
- 60,000 sq ft distribution centre
- Own vehicle fleet for local/national distribution
- Team experienced in supply and service to the Marine, Recreation and Fishing trade
- Offers a range of 20,000+ additional products from the world's leading marine and recreational brands

Bainbridge looks forward to proving its leading sales and service operation – for more information please contact us on 01489 776030 or visit us at www.bainbridgetechnical.com



Contents

Ocean Kayak - Recreation

Banzai.....	3
 Frenzy.....	3
Caper.....	3
Scrambler 11.....	3
Tetra 10.....	4
Tetra 12.....	4
Venus 10.....	4
Venus 11.....	4
 Malibu 2.....	5
 Malibu 2XL.....	5
Zest two Exp.....	5
Nalu 11.....	6
Nalu 12.5.....	6

Ocean Kayak - Fishing

Caper Angler.....	7
Tetra 10 Angler.....	8
Tetra 12 Angler.....	8
Malibu 2 Angler.....	8
Prowler 13 Angler...	8
Trident 11.....	9
 Trident 13.....	9
Trident 15.....	9
 Trident Ultra 4.3.....	9
Trident Ultra 4.7.....	9
 Prowler	
Big Game 2.....	10

Old Town - Fishing

Predator MX.....	12
Predator 13.....	12
 Predator XL/MK. 14	
Twin Heron Angler ..	16
Loon 126 Angler....	17
Loon 106 Angler....	17
Vapor12 Angler....	18
Vapor 10 Angler....	18

Old Town - Recreation

Loon 126.....	20
Loon120.....	20
Loon 106.....	20
Dirigo Tandem.....	21
Dirigo 120.....	21
Dirigo 106.....	21
Vapor 12 XT.....	22
Vapor10 XT.....	22
Vapor 10.....	22
Loon 111 Outfitter ..	23
Heron Twin.....	24
Heron 11XT.....	24
Heron 9XT.....	24
Heron Jr.....	25
Twister.....	25
Next.....	26

Old Town - Canoes

 Saranac 146 ...	28
 Saranac 160 ...	28
Guide 147.....	29
Guide 160.....	29
Discovery 119.....	30
 Discovery 158 ..	30
 Discovery 169 ..	30
Discovery 133.....	31
Discovery Sport 15..	31
Charles River 15...	32
Rogue River 154 SS .	32
Penobscot 164.....	33
 Penobscot 174..	33

Wood - Canoes

Guide 16 Canvas....	34
Guide 16 Fiberglass	34
OTCA 16 Canvas....	34
OTCA 16 Fiberglass	34
Molitor 17 Canvas ..	34
Molitor 17 Fiberglass	34

Necky - Recreation & Touring

Rip 10ft Drop Skeg..	36
Rip 12ft Drop Skeg..	36
Eliza.....	37
Eliza Drop Skeg....	37
Eliza Rudder.....	37
Manitou Sport.....	38
Manitou 13.....	38
Manitou 130R.....	38
Manitou 14.....	38
Manitou II.....	39
Manitou IIR.....	39
Looksha 12.....	40
Looksha 14.....	40
Looksha 17.....	40
Looksha 17	
Composite.....	40
Looksha Elite.....	41
Looksha T.....	41
Elias.....	42
Elias Drop Skeg....	42
Chatham 16.....	42
Chatham 17.....	42

Kayak Paddles

Sabre Paddle.....	43
Value Kayak Paddle	43
 Day Tripper...	44
 Magic Mystic...	44
Magic.....	44
Next.....	44
Magic Plus.....	44
Predator angler....	45
Expedition Angler ..	45
Expedition.....	45
Push Poles.....	45

Canoe Paddles

Value Paddle.....	46
Economy.....	46
Trekker.....	46
Standard.....	46
Goldenlight.....	47
Telescopic Hook	
Paddle.....	47
Ausable.....	47
 Beaver Tail ...	47
Scout.....	47

Boat & Rafting Oars

Wood economy.....	48
Economy Boat Oar..	48
Extra Heavy	
Duty Shaft.....	48
Heavy Duty.....	48

Guide & Outfitter

Standard Kayak	
Paddle.....	49
Magic Outfitter.....	49
Outfitter.....	49
Guide.....	49

Accessories

Plastimo Paddles ..	50
Plastimo Buoyancy	
Aids & Lifejackets	50
Kayak Compass....	50
Plastimo Tenders	
& Dinghies.....	51

Overboard

Waterproof -	
Deck Bags	
& Dry Tubes ..	52-53
Duffel bags.....	54-55
Back Packs.....	55-56
Cases.....	56-60
Accessories.....	60

Gerber

Knives & Tools..	61-65
Survival Kits.....	66
Torches.....	67

Lowrance

Fishfinders.....	68-70
------------------	-------

Scanstrut

Deckseals.....	71
----------------	----

Rokk

Adjustable Mounts..	72
---------------------	----

Starbrite

Cleaning Products..	73
---------------------	----

Tex-Energy

Power Source.....	74
12v Batteries.....	75
Anchors.....	75



Fishing



Family



Tandem



Ladies



Electric



River



Sheltered



Coastal



High Performance



Touring



Classic

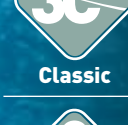

3 LAYER

Construction





Lifetime Hull Warranty.

All Ocean Kayaks have an industry leading lifetime hull warranty. We're on top of that too. Stable and durable boats that are great to paddle in all types of water you enjoy. See our complete warranty information on our website, and enjoy the rest of your life being closer to the water. Limitations apply.

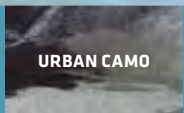

OCEAN RECREATIONAL

BANZAI™ GREAT FOR KIDS!

Fun on the water is the name of the game. That's exactly what you get with the Banzai, our sit-on-top kayak made especially for kids. The low-profile, kid-friendly seat allows easy movement and more mobility for small bodies. The Banzai's Tag Along system, an essential for parents, lets you tow your kids when they're too tired to paddle (though probably not too tired to splash). This playful and maneuverable kayak is perfect for kids of all ages.

FEATURES: Contoured seat well area with an extremely comfortable seat back, lightweight design, Tag Along Tow System, molded-in cup holder, carrying handles, molded-in handles, skid plate.



With the Tag Along Tow System - for tired kids to hitch a ride.



JW0760551225



JW0760551227

Length: 9'6" / 2.9m Width: 28.5" / 72.4cm Weight: 16.3kg Max Capacity: 90.7-104.3kg

FRENZY™

Compact, affordable fun for everyone in the family. Stability makes this boat versatile: it's forgiving in the surf and easy to paddle in calm waters.

FEATURES: Comfort Plus seat, Molded-in seat well, tank well with bungee, molded-in cup holder, molded-in foot wells, molded-in handles, skid plate.

OPTIONS: 6" hatch (center)



TOP
SELLER



JW0762601045



JW0762601040



JW0762601020

Length: 9' / 2.7m Width: 31" / 78.7cm Weight: 20kg Max Capacity: 124.7-147.4 kg

OUTFITTER



JW0762601060



JW0762601061

(Extra Poly, No Seat)

CAPER™

Big fun in a compact package. This stable sea kayak comes complete with a performance hull and storage options rare for boats this size.

FEATURES: Comfort Plus seat, Molded-in seat well, Click Seal bow hatch, tank well with bungee, side mounted carrying handles, molded-in cup holder, molded-in handles, skid plate, paddle holder.

OPTIONS: 6" hatch with cat bag (center)



JW0761601045



JW0761601040



JW0761601020

Length: 11' / 3.4m Width: 31" / 78.7cm Weight: 21.3kg Max Capacity: 124.7-147.4 kg

SCRAMBLER 11™

The ultimate in versatility. Perfect choice for the paddler who may want to surf a little, fish a little or just cruise around.

FEATURES: Comfort Plus seat, Molded-in seat well, 6" Cam Lock hatch with storage bucket, oversized tank well with bungee, bow and stern rope handles, molded-in cup holder, molded-in foot wells, molded-in side handles, paddle holder.

OPTIONS: Oval Cross Lock hatch (bow)



JW0763601045



JW0763601040



JW0763601020

Length: 11'6" / 3.5m Width: 29.5" / 74.9cm Weight: 21.3kg Max Capacity: 136.1-158.8 kg

TETRA 10™

Sleek and sporty, the Tetra series is perfect for the small to medium build paddler. Compact and easy to maneuver the Tetras are equipped with the unique Comfort Hybrid seat back. Nimble and fun – perfect in a variety of water conditions.

FEATURES: Comfort Hybrid seat back, Click Seal bow hatch, Support Track Foot Brace System, tank well with bungee, molded-in cup holder, paddle keeper, side mounted carrying handles.

OPTIONS: Rudder system; Mod Pod II (center hatch)



JW0762541071



JW0762541073



JW0762541075



JW0762541055

Length: 10'8" / 3.3m Width: 29.5" / 74.9cm Weight: 21.3kg Max Capacity: 102.1-124.7 kg

TETRA 12™

The Tetra 12, the longer sibling of the Tetra 10, is a low profile craft with clean lines and a sleek design. It glides and tracks through the water with ease. Equipped with the unique Comfort Hybrid seat back the Tetra is ready to ride the minute you hit the water.

FEATURES: Comfort Hybrid seat back, Click Seal bow hatch, Support Track Foot Brace System, tank well with bungee, molded-in cup holder, paddle keeper, side mounted carrying handles.

OPTIONS: Rudder system; Mod Pod II (center hatch)



JW0762561071



JW0762561073



JW0762561075



JW0762561055

Length: 12'1" / 3.68m Width: 28" / 71.1cm Weight: 24kg Max Capacity: 136.1-158.8kg

VENUS 10™

The perfect boat for smaller paddlers! A super lightweight, easy-to-transport kayak that is designed to accommodate a woman's center of gravity.

FEATURES: Comfort Hybrid seat back, lightweight, tank well with bungee, car-topping handle system, molded-in foot wells, molded-in handles, skid plate, paddle holder.

OPTIONS: 6" hatch (center)



JW0763301043



JW0763301060



JW0762561075

Length: 9'10" / 3m Width: 28" / 71.1cm Weight: 16.8kg Max Capacity: 72.6-79.4kg

VENUS 11™

For every woman who doesn't like "one size fits all," the Venus is stable, easy-to-transport and designed to accommodate a female's center of gravity.

FEATURES: Comfort Hybrid seat back, lightweight, Click Seal bow hatch, tank well with bungee, car-topping handle system, molded-in cup holder, molded-in handles, paddle holder, skid plate.



JW0763401043



JW0763401045



JW0763401063

Length: 10'8" / 3.3m Width: 28.5" / 72.4cm Weight: 44kg Max Capacity: 90.7-102kg



Ladies

MALIBU TWO™ TANDEM

A compact, lightweight tandem designed for affordable family adventure. Stable and versatile with seating for one or two plus a small child or pet.

FEATURES: Comfort Plus seats, three molded-in seat wells, gear straps, patented overlapping foot wells, molded-in handles, skid plate.

OPTIONS: Up to three round Gaspachi hatches (bow, center, stern)

Covered by one or more of the following patents: Design Patent: D377473; Utility Patent: 6152063; Utility Patent: 6178912



JW0760101073



JW0760101040



JW0760101020

Length: 12' / 3.7m

Width: 34" / 86.4cm

Weight: 25.9kg

Max Capacity: 170.1-192.8 kg

OUTFITTER



JW0760101060



JW0760101061

(Extra Poly, No Seat)



MALIBU TWO XL™

A stable and versatile kayak built for family adventure. Patented seating for one, two or two plus a small child or pet. Slightly larger than the classic Malibu Two.

FEATURES: Comfort Plus seats, overlapping foot wells, deck bungee, molded-in handles, skid plate, paddle holder.

OPTIONS: Up to two round Gaspachi hatches (bow, stern), oval Cross Lock hatch (center)

Covered by one or more of the following patents: Design Patent: D377473; Utility Patent: 6152063; Utility Patent: 6178912



JW0762901071



JW0762901073



JW07629030300



JW0762903020

Length: 13'4" / 4.1m

Width: 34" / 86.4cm

Weight: 30.8kg

Max Capacity: 204.1-226.8kg

OUTFITTER



JW0762901060



JW0762901061

(Extra Poly, No Seat)



ZEST TWO EXP™ TANDEM

Perfect for a day trek or a weekend adventure. Abundant storage options make sure your gear can go with you.

FEATURES: Two molded-in seat wells, oversized tank well with bungee, deck bungee, molded-in cup holders, molded-in foot wells, skid plate, mold-in handles, Comfort Plus seats.



JW0764601030



JW0764601020

Length: 16'4.5" / 5m

Width: 30.5" / 77.5cm

Weight: 34kg

Max Capacity: 226.8-272.2kg



NALU 11™ SUP

At 11 feet, the Nalu 11 is at home in the ocean or on rivers – it's highly maneuverable and much tougher than a composite board. For affordable stand up paddling the Nalu 11 is a great choice.

FEATURES: A textured foot area designed to optimize balance, comfortable seating area, storage bungee, drain plug, molded-in integral fins, carrying handles, bow and stern toggle handles, padded foot wells.



JW0764901043



JW0764901045



JW0764901013

Length: 11' / 3.4m

Width: 31" / 78.7cm

Weight: 20kg

Max Capacity: 102.1-124.7kg

NALU 12.5™ SUP

Long and fast, the Nalu 12.5 puts long distance voyages within reach. Perfect for an entry level to intermediate stand up paddler. Equipped with roomy bow hatch making it easy to enjoy the ride standing up or sitting down.

FEATURES: Textured foot area designed to optimize balance, Quick Seal hatch with Cross Lock™ buckle system, comfortable carrying handles, storage bungee, drain plug, molded-in integral fins, bow and stern toggle handles, padded foot wells.



JW0764951043



JW0764951045



JW0764951013



JW0764951015

Length: 12'6" / 3.8m

Width: 30.5" / 77.5cm

Weight: 22.7kg

Max Capacity: 136.1-158.8kg





- ORANGE CAMO
- LEMONGRASS
- URBAN CAMO
- ENVY
- BROWN CAMO
- BLUE CAMO

Fishing Kayaks

Allow us to bait you with the perfect top water presentation.



CAPER™ ANGLER

Stable and easy to maneuver, Caper's compact size will get you to that sweet fishing spot or remote campsite.

FEATURES: Comfort Plus Seat, molded-in seat well, Click Seal bow hatch, tank well with bungee, molded-in cup holder, molded-in handles, paddle holder, skid plate, flush mount rod holders.

OPTIONS: 6" hatch (center)

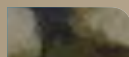

JW0761603153



JW0761603155

Length: 11' / 3.4m

Width: 31" / 78.7cm

Weight: 21.3kg

Max Capacity: 124.7-147.4kg

OCEAN FISHING

TETRA ANGLERS

Looking for a fishing kayak that is easy to store and easy to transport? The Tetra Angler is a great choice. Perfect for those with a small-to-medium-build, the Tetra Angler is compact, nimble and extremely maneuverable.

FEATURES: Comfort Hybrid seat back, Modular Fishing Pod (Mod Pod II), two flush mount rod holders, Click Seal bow hatch, Support Track Foot Braces, large tank well with bungee, molded-in cup holder, paddle keeper, angler graphics, side mounted carrying handles.

OPTIONS: Rudder system



Sheltered



TETRA 10 ANGLER

COMFORT HYBRID SEAT

CLICK SEAL HATCH

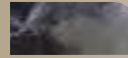

JW0762541060 JW0762541062

Length: 10'8" / 3.25m Width: 29.5" / 74.9cm Weight: 22.7kg Max Capacity: 102.1-124.7kg



TETRA 12 ANGLER

COMFORT HYBRID SEAT

CLICK SEAL HATCH



JW0762561060 JW0762561062

Length: 12'1" / 3.68m Width: 28" / 71.1cm Weight: 25.4kg Max Capacity: 136.1-158.8kg

MALIBU TWO XL™ TANDEM ANGLER

Over 450 pounds of capacity plus great stability adds up to a great choice for two anglers and their gear. Perfect for introducing the sport of fishing to kids.

FEATURES: Two Comfort Plus seat backs that can easily be repositioned to face each other, four deck mounts, two rod holders, center hatch with Cross Lock buckle system, deck bungee, paddle holder, skid plate, molded-in handles.

OPTIONS: Up to two round Gaspachi hatches (bow, stern)

Covered by one or more of the following patents: Design Patent: D377473; Utility Patent: 6152063; Utility Patent: 6178912



Sheltered



COMFORT PLUS SEATS

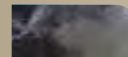

JW0762901063 JW076290165

Length: 13'4" / 4.1m Width: 34" / 86.4cm Weight: 33.6kg Max Capacity: 204.1-226.8kg

PROWLER 13™ ANGLER

This popular angler kayak combines performance with all of the features every angler needs.

FEATURES: Comfort Plus Seat, molded-in seat well, flush mount rod holders, large bow hatch, Click Seal bow hatch, oversized tank well with bungee, deck bungee, transducer compatible scupper, molded-in cup holder, molded-in handles, skid plate.

OPTIONS: Rudder system



Sheltered



Coastal



COMFORT PLUS SEAT

CLICK SEAL HATCH

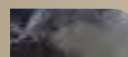

JW0763801060 JW0763801062 JW0763801168 JW0763802019

Length: 13'4" / 4.1m Width: 28" / 71.1cm Weight: 25.4kg Max Capacity: 181.4-204.1kg

TRIDENT™ SERIES ANGLER

Got fish? With the help of our Modular Fishing Pod you soon will. Featured on the Trident 11 and 13 this central command center provides unmatched flexibility for rod mounts along with sports trays for odd-shaped lures, and it even has a built-in ruler to make sure that catch is legal.

FEATURES: Comfort Hybrid seat back, Modular Fishing Pod, Sonar Shield*, Cannon rod holder, large bow hatch with Cross Lock buckle system, Support Track Foot Brace System, battery bag, oversized tank well with bungee, transducer compatible scupper, reflective deck rigging, skid plate, paddle holder, molded-in side handles.

OPTIONS: Rudder system

*Sonar Shield is standard on the Trident 13 & 15 only



Trident 13

- Skid Plate (not shown)
- Oversized tank well
- Comfort Hybrid seat back
- Versatile Modular Fishing Pod
- Sonar Shield*
- Click-Seal Hatch

TRIDENT 15™ ANGLER

- JW0764701120
- JW0764701126
- JW0764701122
- JW0764701124

Length: 15'7.5" / 4.8m Width: 29" / 73.7cm Weight: 31.75kg Max Capacity: 226.8-249.5kg

TRIDENT 13™ ANGLER

- JW0764401120
- JW0764401126
- JW0764401122
- JW0764401124

Length: 13'6" / 4.1m, Width: 29.5" / 74.9cm
Weight: 30.4kg, Max Capacity: 192.8-215.5kg

TRIDENT 11™ ANGLER

- JW0764301120
- JW0764301124
- JW0764301122
- JW0764301126

Length: 11'5" / 3.5m, Width: 30.5" / 77.5cm
Weight: 25.4kg, Max Capacity: 158.9-181.4kg

TRIDENT ULTRA 4.3™ ANGLER

First introduced 'down under' the Trident Ultra series was crafted in collaboration with pro kayak anglers from around the globe. Fast and nimble the Ultra 4.3 can handle ocean swells and glide through calm waters with surprising speed. Based on the Ultra 4.7 this shorter sibling is loaded with even more innovative features making it the benchmark for fishing kayaks.

FEATURES: Comfort Hybrid seat back, multi-functional, reversible center hatch cover, four flush mount rod holders plus in the rear, Click Seal bow hatch, adjustable foot braces, 5" hatch in the rear tank well, oversized tank well designed to take the Ice Box Storage Pod (see accessories), transducer compatible scupper with more size options, molded-in cup holder and bottle holder, replaceable wear strip on tail fin, paddle holder, molded-in side handles.

OPTIONS: Rudder system



- Tank well fits accessory Ice Box
- Multi-functional, reversible center hatch cover.

- JW0764252065
- JW0764250077
- JW0764252067
- JW0764252080

Length: 14'1" / 4.3m Width: 29.1" / 74cm Weight: 30.8kg Max Capacity: 147.4-158.8kg

TRIDENT ULTRA 4.7™ ANGLER

The big sister to the Ultra 4.3. The Ultra 4.7 is built around the original Prowler hull. The Ultra incorporates volume across the bow for a drier ride, a moderate rocker to help performance in ocean swells, and a more pronounced fin to aid in tracking.

FEATURES: Comfort Hybrid seat back, multi-functional reversible center hatch cover, four flush mount rod holders, Click Seal bow hatch, live bait well, oversized tank well designed to take the Ice Box Storage Pod (see accessories), transducer compatible scupper, molded-in cup holder, bottle holder, replaceable wear strip on tail fin, paddle holder, molded-in side handles, rudder system.



- Multi-functional, reversible center hatch cover. Can be fastened securely with either side facing up.

- JW0764251065
- JW0764250032
- JW0764251067
- JW0764251080

Length: 15'5" / 4.7m Width: 29.1" / 74cm Weight: 39.5kg Max Capacity: 181.4-204.1kg

THE NEW PROWLER BIG GAME II PUTS YOU ON TOP OF THE FOOD CHAIN.

The 2014 Prowler Big Game II features the all new Element seating system with multi-position options for the ultimate on-water experience. The all-day comfort of the Element seat, combined with stern stingers designed to carry volume in the rear of the boat, the Prowler Big Game II is BIG on stability and comfort. New to the Prowler Big Game II are 6 strategically placed mounting brackets. These allow you to equip all your gear around you just the way you want it, without drilling into your hull. The Prowler provides plenty of storage space and includes the easy-to-use Click Seal bow hatch cover to keep your gear secure and dry. All of these features and more make the all new Prowler Big Game II perfect for going after the 'big one'.

FEATURES:

- Element Seating System
- 6 Accessory Mount Plates
- Oversized tank well with bungee
- Click Seal bow hatch
- Glide Track foot brace system
- Transducer compatible scupper
- Mod Pod center hatch cover
- Built in carry handles
- Paddle keepers
- Optional Rudder Kit available

The new Prowler Big Game II is a fishing machine on any water.



JW0764001060



JW0764007030



JW0764001062



JW0764001013

Length: 12'9" / 3.9m

Width: 34" / 86.4cm

Weight: 39.5kg

Max Capacity: 249.5-272.2kg

Seat Width: 21" / 45.7cm

Seat Height: 15" / 38.1cm

Leg Length: 50" / 127cm

Bow Hatch: 16.5" x 10.5" / 41.9 x 26.7cm



Sheltered



Coastal



High
Performance



A lifetime's a long time. We're here to make sure you get the most of out of it.

All Old Town canoes and kayaks have an industry leading lifetime hull warranty. It's a bond that we've had with

all of our boat owners. We just made it formal. To have and to hold, till death do us part. See our complete warranty information on our website. Limitations apply.

Variety of manufacturing and materials designed for custom performance.

Each of our boats are designed with the paddler, their environment and function in mind. We have a strong history being first to market with new materials and processes. Regardless of the materials and hull design, know that every Old Town Canoe or Kayak is still hand crafted and finished. We are proud of this heritage and how it defines us. Visit our website to learn more about the processes and materials.



Old Town[®]
CANOES  KAYAKS

THERMOFORMED POLYETHYLENE

Thermoforming uses a single plastic sheet of high density polyethylene that literally forms a canoe right over a mold. The thermoformed plastic material is durable and provides better abrasion and impact resistance than more expensive fiberglass hulls. Compared to aluminum the plastic hull is less prone to denting and quieter during on water activity.



SINGLE LAYER POLYETHYLENE

Single layer is just that, one precisely molded layer of high performance plastic material - we named it LT9000. It's a proprietary blend of polyethylene that doesn't sacrifice weight for durability or stiffness. LT9000 delivers a great ride along with a super feel for the water under you.



THREE LAYER POLYETHYLENE

This technology allows us to produce a stiffer craft versus a traditional single-layered kayak and omits the need for added foam billets. A foam core is sandwiched in the middle of two layers of polyethylene providing built-in flotation and insulation from cold and noise.



DURABILITY **ABRASION RESISTANCE** **WEIGHT** **STIFFNESS** **COST**



- URBAN CAMO
- BROWN CAMO
- LIME CAMO
- BLACK CHERRY
- SUNRISE
- CLOUD
- RED
- LEMONGRASS
- BLUE
- BLUE
- YELLOW
- GREEN



OLD TOWN FISHING

PREDATOR¹³ PREDATOR^{MX}

PREPARE YOURSELF FOR A TOTALLY NEW FISHING EXPERIENCE. THE PREDATOR WILL BRING YOU CLOSER TO THE WATER AND THE ACTION WITH HIGHLY CUSTOMIZED FEATURES THAT ARE ENGINEERED TO MEET THE NEEDS OF AVID ANGLERS AND WEEKEND WARRIORS, ALIKE.

THE PREDATOR MX

More than a shorter version of the Predator 13. The MX stands for "mixed water" meaning this boat is designed to be equally at home on small bays, lakes, and ponds or moving water rivers and streams. The Predator MX is engineered with a small amount of additional rocker and a more blunt bow to allow it to be more maneuverable in river use. It also incorporates a wide open Exo-Ridge™ deck perfect for tackle management and spacious comfort.

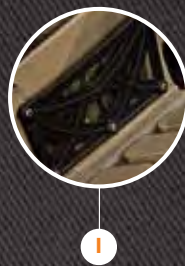
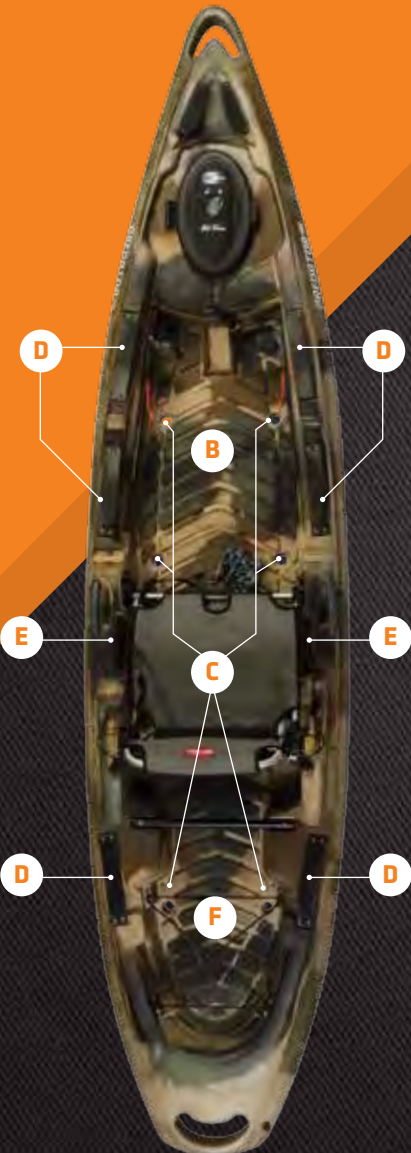

- A PERFORMANCE CRAFTED TRI-HULL**
LT900 polyethylene delivers incredible durability and strength. Tri-Hull design offers superior stability and tracking.
- B SLIP RESISTANT EXO-RIDGE DECK**
Proprietary textured design ensures you and your gear stay dry and secure.
- C SCUPPER HOLES**
8 scupper holes drain away any water that enters the kayak, and include our patented one-way Scupper Valves.
- D 6 REMOVABLE MOUNTING PLATES**
Strategically placed high-strength mounts mean no more drilling into your boat hull. Customize with rod holders, fish finders, slide tracks or GPS.
- E ROD TIP HOLDERS & ROD RETAINER BUNGEEES**
Dual-tip holders at the bow make storing easy. Side-mounted retainers allow for convenient grab-and-cast.
- F EXO-RIDGE TANK WELL**
Large capacity Exo-Ridge design keeps all your gear accessible and dry. Ideal for cooler, battery for trolling motor or tackle boxes.



River



Sheltered



See website for details.

	LENGTH	WIDTH	WEIGHT	SEAT WIDTH	SEAT HEIGHT	LEG LENGTH	BOW HATCH	MAX CAPACITY
PREDATOR¹³	13' 2"	33.5"	86LBS	21"	15"	48"	16.5"X10.5"	400LBS - 425LBS
PREDATOR^{MX}	12'	34"	82LBS	21"	15"	48"	14"X7.5"	375LBS - 400LBS

Old Town[®] ANGLER

COLOR & CAMOUFLAGE

13 JW0164850131 JW0164850133 JW0164850137 JW0164850135



URBAN CAMO



BROWN CAMO



LIME CAMO



BLACK CHERRY

MX JW0164800131 JW0164800133 JW0164800137 JW0164800135

THE PREDATOR 13

The Predator 13 has been completely engineered - below and above the waterline - to deliver the perfect platform for fishing and on-water sporting. Old Town Pro Staff examined seating, rod placement, paddle holders and total "fish-ability" and incorporated it all into this revolutionary boat. The Predator 13 is designed to handle larger bodies of water like lakes, bays, and coastal areas. The slip-resistant Exo-Ridge deck ensures that you and your gear stay dry and secure.



G MOLDED PADDLE REST
Molded paddle rests allow for a quick placement to free up your hands.

H LARGE BOW HATCH WITH CLICK SEAL COVER
Roomy hatch opening is perfect for gear bags and more. Locks securely with one simple click. Keeps gear secure and dry.

I DUAL TACKLE HOLDERS
Convenient recessed storage on both sides provides quick access to your gear.

CENTER CONSOLE WITH MOD POD COVER (PREDATOR 13 ONLY)
Mount arrange and customize gear, including paddle leashes, GPS, fish finders and rod holders, open to reveal storage access.

YOUR EQUIPMENT. RIGHT WHERE YOU WANT IT.

CUSTOMIZE YOUR PREDATOR

The Predator comes equipped with all the essentials needed to take your fishing experience to the next level. That includes giving you the ability to customize your boat to meet your exact style and preferences.

AVAILABLE OPTIONS

Steady-Stand Bar - Additional support when standing.
Trolling Motor Mount - Makes it easy to add power.
Unlimited Opportunities - The Predator's multiple mounting plates let you add all the greatest accessories from makers like Cannon[®], Scotty[®], YakAttack[®] and RAM Mounts[®].

GET CONNECTED

Something changes when you take your fishing to the surface level. It alters the playing field and provides a more personal connection to your environment - and the battles that take place there. You just may find the closer you get to the water, the further you can take your game.

PREDATOR XL



THE NEWEST ADAPTATION OF OUR REVOLUTIONARY PREDATOR HAS BEEN UNLEASHED. A FULLY EVOLVED HYBRID, THAT CHANGES AS QUICKLY AS WE JUST CHANGED KAYAK SPORTFISHING.

XL CONSOLE SYSTEM – ADAPT IN A SNAP

Like the rest of the family, XL incorporates all the innovative Predator features that put anglers on top of the food chain. And now introduces an industry changing Modular Console System, designed for electronics, storage and power customization in just seconds. Quickly convert to power by Minn-kota, for completely hands-free all-day navigation, trolling or structure fishing.

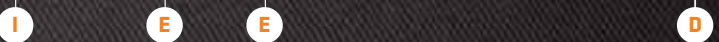
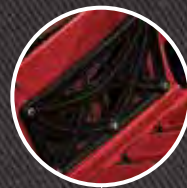
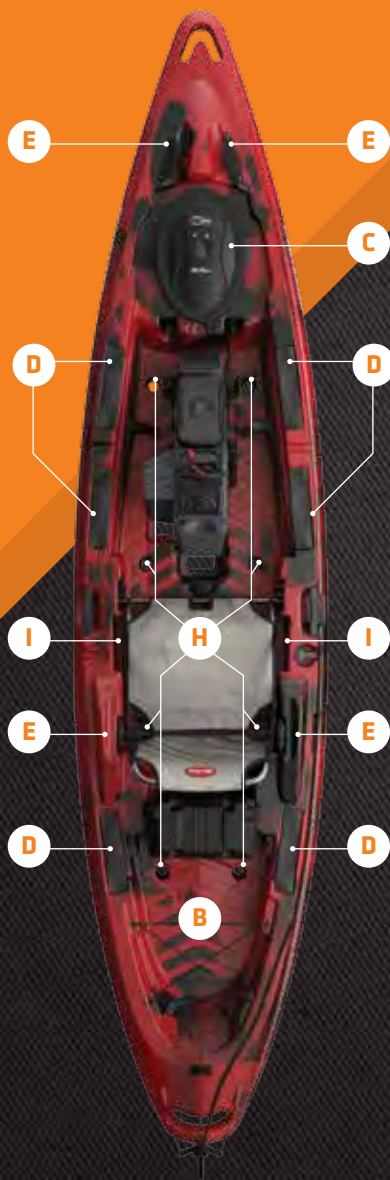

- A PERFORMANCE CRAFTED TRI-HULL**
LT900 polyethylene delivers incredible durability and strength. Tri-Hull design offers superior stability and tracking.
- B SLIP RESISTANT EXO-RIDGE DECK**
Proprietary textured design ensures you and your gear stay dry and secure.
- C LARGE BOW HATCH WITH CLICK SEAL COVER**
Roomy hatch opening is perfect for gear bags and more. Locks securely with one simple click. Keeps gear secure and dry.
- D 6 REMOVABLE MOUNTING PLATES**
Strategically placed high-strength mounts mean no more drilling into your boat hull. Customize with rod holders, fish finders, slide tracks or GPS.
- E ROD TIP HOLDERS AND ROD RETAINER BUNGIES**
Dual-tip holders at the bow make storing easy. Side-mounted retainers allow for convenient grab-and-cast.



See website for details.

	LENGTH	WIDTH	WEIGHT	SEAT WIDTH	SEAT HEIGHT	LEG LENGTH	BOW HATCH	MAX CAPACITY
PREDATOR XL	13' 2"	36"	92LBS WITHOUT CONSOLES	21"	15"	48"	16.5"X10.5"	600LBS

Old Town ANGLER

COLOR & CAMOUFLAGE

JW0164900820 JW0164900800 JW0164900830 JW0164900810



THE PREDATOR 13



G MOLDED PADDLE REST
Molded paddle rests allow for a quick placement to free up your hands.

H SCUPPER HOLES
8 scupper holes drain away any water that enters the kayak, and include our patented one-way Scupper Valves.

I DUAL TACKLE HOLDERS
Convenient recessed storage on both sides provides quick access to your gear.

STAND-UP ASSIST STRAP
Provides added leverage when standing (not shown).



PORTABLE 10 AMP CHARGER
Get power to go, with this portable charger. Avoid overcharging or undercharging. Recovery time for 12V/6-cell batteries is only 4-6 hours.



PREDATOR ANGLER PADDLE
Lightweight and highly durable blades in new tactical and urban camo patterns. Hook-notch design to makes quick work of retrieving hard to reach snagged lines and lures.
Lengths: 220, 230, 240, 250cm

MINN-KOTA AND OLD TOWN - TOGETHER A HISTORY OF BEING ON THE WATER FOR OVER 180 YEARS. YOU COULDN'T FIND MORE EXPERIENCED FISHING PARTNERS.



J



LENGTH 29"
HEIGHT 25"
WIDTH 12"
WEIGHT 25.5 Lbs

MINN-KOTA CONSOLE

Complete hands-free navigation and trolling with 45 lbs of variable thrust. With forward and reverse, Predator's saltwater grade power console delivers and keeps you on the fish all day.

JW0113312800

LENGTH 29"
HEIGHT 15"
WIDTH 12"
WEIGHT 8 Lbs



UTILITY CONSOLE

Engineered as a complete and quickly removable sonar electronics management system.

JW0113312810

LENGTH 29"
HEIGHT 8"
WIDTH 12"
WEIGHT 6 Lbs



EXO-RIDGE CONSOLE

Flush-mount open paddle deck for wide-open big game fishing. With a 600lb capacity, any size is welcome aboard.

JW0113312812

Twin Heron Angler

A compact, sporty design, the Heron Angler series is an easy-to-paddle kayak that can maneuver perfectly into your favorite fishing spot. A great choice for casual anglers who are seeking an affordable, lightweight kayak for fishing and cruising in calm waters.

FEATURES:

- Comfort Flex Seat with Padding
- Support Track Foot Brace System
- Removable Front Seat
- Six Rod Mount Receivers
- Two Cannon Rod Holders
- Paddle Holders
- Rear Bungee

TWIN HERON ANGLER

Length	13' 6" / 4.1 m
Width	31.5" / 80 cm
Cockpit	23" x 93.5" / 58.4 x 237.5 cm
Deck height	15.5" / 39.4 cm
Weight	62 lbs / 28.1 kg
Max load range	450 - 500 lbs / 204.1 - 226.8 kg
Material	Three layer polyethylene

LOON 106 ANGLER



JW0140541072

JW0140541070



Touring



Tandem



Fishing



The New LOON ANGLER SERIES

LOON 126 ANGLER

The Loon Angler features a sleek new hull design, which is both zippy and forgiving.

With extra width and volume for stability, and incorporating the all new ACS2 seat, the Loon Angler is designed to be the most comfortable sit-inside angling kayak on the water. The new Loon Angler includes flush-mount rod holders and anchor system, and features a revolutionary new workdeck with USB and built-in storage, allowing you to easily outfit it for an adventurous day on the water.

LOON 106 ANGLER

	LOON 106 ANGLER	LOON 126 ANGLER
Length	10' 6" / 3.2 m	12' 6" / 3.8 m
Width	31" / 78.7 cm	31" / 78.7 cm
Cockpit	23" x 56" / 58.4 x 142.2 cm	23" x 56" / 58.4 x 142.2 cm
Deck height	17.5" / 44.5 cm	17.25" / 43.8 cm
Weight	46 lbs / 20.9 kg	59 lbs / 26.8 kg
Max load range	325 lbs / 147.4 kg	450 lbs / 204 kg
Material	Three layer polyethylene	Three layer polyethylene

LOON 106 ANGLER



JW0155210200



JW0155210202

LOON 126 ANGLER



JW0155270200

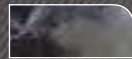

JW0155270202



High Performance



Fishing



REMOVABLE WORKDECK WITH USB

- 1) Quick-Lock Feature for Fast and Easy Attachment
- 2) USB Port for Charging Gadgets
- 3) Slide Mount Track for Accessories
- 4) Dry Storage Compartment and Gear Trays
- 5) Cup Holder and Water Bottle Cage Mount (not shown)
- 6) Cell Phone Tray with Bungee

* CGI images used. Final product and colour pattern will vary from images shown.

Vapor Angler SERIES

Our Vapor Angler kayaks are value packed for the weekend warrior. They provide the right amount of fishing features to get you started along with a roomy cockpit, and stable, efficient hull. Just bait and cast, and you are ready to reel in the big one!

VAPOR 10 & 12 FEATURES:

- Comfort Flex Seat
- Glide Track Foot Brace System
- Stern Day Well
- Thigh Pads
- Molded-in Paddle Rest
- Molded-in Cockpit Tray with Cup Holder
- Anchor Trolley System
- Flush Mount Rod Holders
- Skid Plate

VAPOR 12 ANGLER

VAPOR 10 ANGLER

	VAPOR 10 ANGLER	VAPOR 12 ANGLER
Length	10' / 3 m	12' / 3.7 m
Width	28.5" / 72.4 cm	28.5" / 72.4 cm
Cockpit	19.5" x 48" / 49.5 x 121.9 cm	19.5" x 49" / 49.5 x 124.5 cm
Deck height	16.75" / 42.6 cm	17.25" / 43.8 cm
Weight	49 lbs / 22.2 kg	56 lbs / 25.4 kg
Max load range	275 - 325 lbs / 124.7 - 147.4 kg	325-375 lbs / 147.4 - 170.1 kg
Material	Single layer polyethylene	Single layer polyethylene

VAPOUR 10 ANGLER

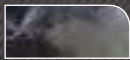
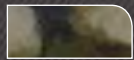

JW0164001072 JW0164001070

VAPOUR 12 ANGLER

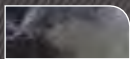
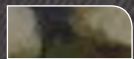

JW0164601072 JW0164601070





- URBAN CAMO
- BROWN CAMO
- LIME CAMO
- BLACK CHERRY
- SUNRISE
- CLOUD
- RED
- LEMONGRASS
- BLUE
- BLUE
- YELLOW
- GREEN

Old Town[®]
CANOES  KAYAKS

OLD TOWN RECREATIONAL

The New SERIES

Introducing the worlds most advanced recreational kayak. 20 years ago Old Town canoe changed the way paddle sports thought about recreational kayaks with the Loon Series. Two years ago the team at Old Town set out to recreate the ultimate recreational kayak. The new Loon series features a completely redesigned hull that provides effortless glide and straight tracking. The Loon features a removable workdeck providing space for customization, cameras and gear and water. The workdeck also features dry storage and a USB charge port to keep your gadgets charged even after hours on the water. Available in multiple sizes and featuring maximum capacities of 375 and 400 pounds, the new Loon is designed to fit a wide range of paddlers.

FEATURES:

- Active Comfort System 2.0 (ACS2) Seat
- Thigh Pads (Match ACS2 Paddling)
- Click Seal Hatch with Bulkhead
- Support Track Foot Brace System
- Durable Three-layer Construction
- Removable Workdeck with USB **INCLUDED!**
- 3 sizes + ACS2 Seat = Perfect Paddler Fit
- Bow and Stern Deck Bungees
- Bow and Stern Carry Handles
- Sharp Keel Line for Performance

	LOON 106	LOON 120	LOON 126
Length	10' 6" / 3.2 m	12' / 3.6 m	12' 6" / 3.8 m
Width	31" / 78.7 cm	30" / 76.2 cm	31" / 78.7 cm
Cockpit	23" x 56" / 58.4 x 142.2 cm	22" x 56" / 55.9 x 142.2 cm	23" x 56" / 58.4 x 142.2 cm
Deck Height	17.5" / 44.5 cm	15.25" / 38.7 cm	17.25" / 43.8 cm
Weight	45 lbs / 20.4 kg	55 lbs / 25 kg	58 lbs / 26.3 kg
Max load range	325 lbs / 147.4 kg	375 lbs / 170 kg	450 lbs / 204 kg
Material	Three layer polyethylene	Three layer polyethylene	Three layer polyethylene



JW0155210106



JW0155210102

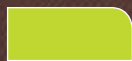

JW0155210104



JW0155210100



JW0155260106



JW0155260102

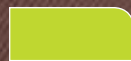

JW0155260104



JW0155260100



JW0155270106



JW0155270102

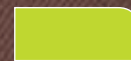

JW0155270104



JW0155270100

LOON 106



High Performance



LOON 120



High Performance



LOON 126



High Performance



Dirigo SERIES

The time-tested Dirigo is beloved for its friendly, easy-to-paddle nature. A roomy cockpit and excellent initial stability make this family a good choice for almost anyone.

FEATURES:

- Contoured Poly Seats
- Glide Track foot brace system
- Click Seal hatch with bulkhead
- Bow and Stern Grab Handles
- Cup Holder
- Deck bungees
- Skid Plate

	DIRIGO 106	DIRIGO 120	DIRIGO TANDEM
Length	10' 6" / 3.2 m	12' / 3.7 m	15' 3" / 4.7 m
Width	27.75" / 70.5 cm	27.75" / 70.5 cm	29.5" / 74.9 cm
Cockpit	14" / 35.6 cm	14" / 35.6 cm	14" / 35.6 cm
Deck Height	42 lbs / 19 kg	50 lbs / 22.7 kg	72 lbs / 32.7 kg
Weight	250 - 300 lbs / 113.4 - 136.1 kg	300 - 350 lbs / 136.1 - 158.8 kg	425 - 475 lbs / 192.7 - 215.5 kg
Max load range	Three layer polyethylene	Three layer polyethylene	Three layer polyethylene
Material	Three layer polyethylene	Three layer polyethylene	Three layer polyethylene



JW0168201086

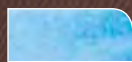

JW0168201084



JW0168301086



JW0168301084



JW0168351086



JW0168351084

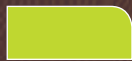

JW0168201084



JW0168201082

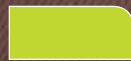

JW0168301084



JW0168301082

DIRIGO 106



Touring

DIRIGO 120



Touring

DIRIGO TANDEM



Touring



Tandem

Vapor SERIES

This sporty kayak series offers a stable, efficient and comfortable ride. A large cockpit opening offers ample room to move around. These high volume kayaks can really pack a load.

BASE FEATURES:

- Comfort Flex Seat
- Glide Track Foot Brace System
- Stern Day Well
- Molded-in Cockpit Tray with Cup Holder
- Molded-in Paddle Rest
- Thigh Pads
- Drain Plug
- Skid Plate

XT FEATURES:

XT INCLUDES BASE FEATURES, PLUS:

- Added Seat/Back Padding
- Support Track Foot Brace System
- Click Seal Hatch

	VAPOR 10	VAPOR 10XT	VAPOR 12XT
Length	10' / 3 m	10' / 3 m	12' / 3.7 m
Width	28.5" / 72.4 cm	28.5" / 72.4 cm	27.5" / 69.9 cm
Cockpit	19.5" x 48" / 49.5 x 121.9 cm	19.5" x 48" / 49.5 x 121.9 cm	19.5" x 47" / 49.5 x 119.4 cm
Deck Height	16.75" / 42.6 cm	16.75" / 42.6 cm	16.25" / 41.3 cm
Weight	47 lbs / 21.3 kg	49 lbs / 22.2 kg	56 lbs / 25.4 kg
Max load range	275 - 325 lbs / 124.7 - 147.4 kg	275 - 325 lbs / 124.7 - 147.4 kg	325 - 375 lbs / 147.4 - 170.1 kg
Material	Single layer polyethylene	Single layer polyethylene	Single layer polyethylene



JW0164001042



JW0164001040



JW0164101054



JW0164101052



JW0164101056



JW0164101050



JW0164601054



JW0164601052



JW0164601056



JW0164601050

VAPOR 10



VAPOR 10XT



VAPOR 12XT



Loon 111 OUTFITTER

An outfitter favorite, the Loon 111 is a classic in the Old Town line. Built using three layer technology this kayak is durable and can stand the test of time. The extra roomy cockpit combined with optimal stability make this a reassuring ride for those first learning to paddle. Equipped with a bomber seat, a paddle keeper and the new Glide Track foot brace system.

FEATURES:

- Adjustable Seat
- Glide Track Foot Brace System
- Large Roomy Cockpit
- Rear Deck Bungee Rigging and Paddle Keeper
- Cup Holder



Length	11' 1" / 3.38 m
Width	28" / 71.1 cm
Cockpit	17" x 55" / 43.2 x 139.7 cm
Deck Height	14" / 35.6 cm
Weight	45 lbs / 20.4 kg
Max load range	275 lbs / 124.7 kg
Material	Three layer polyethylene



TWIN Heron

The Twin Heron is truly a unique tandem kayak with our innovative Auto Trim Hull. It performs equally as well when paddled tandem or solo, and eliminates the bow popping up when a solo paddler is seated in the stern seat.

FEATURES:

- Removable Front Seat
- Auto Trim Hull - for Solo Paddling
- Glide Track Foot Braces
- Carrying Handles
- Cup Holders
- Paddle Holders
- Rear Bungee

Removable Front Seat



Length	13' 6" / 4.1 m
Width	31.5" / 80 cm
Cockpit	23" x 93.5" / 58.4 x 237.5 cm
Deck Height	15.5" / 39.4 cm
Weight	60 lbs / 27.2 kg
Max load range	450 - 500 lbs / 204.1 - 226.8 kg
Material	Three layer polyethylene



Heron SERIES

The Heron series is a result of many decades of building recreational kayaks. With a compact, sporty design the Heron series is easy-to-paddle, tracks well, and maneuvers with ease. Perfect for beginning paddlers who are seeking a stable, lightweight kayak designed for having FUN on the water.

FEATURES:

- Comfort Flex Seat
- Glide Track Foot Brace System
- Comfortable Carrying Handles
- Cup Holder
- Added Seat/Back Padding
- Support Track Foot Brace System
- Stern Click Seal Hatch and Bulkhead
- Thigh Pads and Paddle Keeper

	HERON 9XT	HERON 11XT
Length	9' 6" / 2.9 m	11' / 3.35 m
Width	28.5" / 72.4 cm	28.5" / 72.4 cm
Cockpit	19" x 39.5" / 48.3 x 100.3 cm	18.625" x 39.375" / 47.3 x 100 cm
Deck Height	13" / 33 cm	13.5" / 34.3 cm
Weight	37 lbs / 16.8 kg, 39 lbs / 17.7 kg	41 lbs / 18.6 kg
Max load range	225 - 300 lbs / 102 - 136.1 kg	250 - 325 lbs / 113.4 - 147.4 kg
Material	Single layer polyethylene	Single layer polyethylene



JW0140471042



JW0140471044

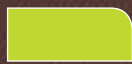

JW0140471040



JW0140470027



JW0140511042



JW0140511044

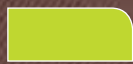

JW0140511040



JW0140510027

HERON 9XT



HERON 11XT



Heron JR.

To introduce your child to the independence of paddle sports, we'd like to introduce you to Heron Jr. Extremely efficient and lightweight, this boat tracks straight even when using the Tag Along Tow System.

FEATURES:

- Just for Kids!
- Tag Along Tow System
- Extremely Lightweight
- Contoured Seat
- Foam Billet

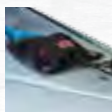

tag along



HERON JR.

Length	7' 5" / 2.3 m
Width	25" / 63.5 cm
Cockpit	16.25" x 35" / 41.3 x 88.9 cm
Deck Height	10.5" / 26.7 cm
Weight	26 lbs / 11.8 kg
Max load range	100 - 115 lbs / 45.4 - 52.2 kg
Material	Single layer polyethylene



JW0140481042

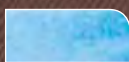

JW0140481040

Twister

The Twister is a low-maintenance sit-on-top kayak offering an extremely stable ride. This fun, yet affordable kayak, makes it easy to enjoy the day on the water. An outfitter favorite, the Twister fits most body types comfortably. Designed to take on everything from rivers to waves, to ponds or lakes.

FEATURES:

- Molded-In Seat & Footwells
- Large Tank Well with Bungee
- Comfortable, Side Molded-In Grab Handles
- Bow and Stern Grab Handles
- Skid Plate
- Cup Holder



TWISTER

Length	11' 3" / 3.4 m
Width	30" / 76.2 cm
Cockpit	13.75" / 35 cm
Deck Height	46 lbs / 20.9 kg
Weight	225-275 lbs / 102.1-124.7 kg
Max load range	Single layer polyethylene
Material	Three layer polyethylene



JW0155540194



JW0155540192

YOU'RE NEXT.

PREPARE YOURSELF FOR A PERSONAL PADDLING EXPERIENCE UNLIKE ANY OTHER.

From the company with a rich 100-year history in paddlesports, comes a product that represents the future. The NEXT is a totally fresh and uniquely fun solo experience that brings a century of expertise into one truly amazing personal watercraft unlike any other. Built for one, but designed for all, the NEXT represents a new generation of boating for today's generation of paddle, outdoors and fitness enthusiasts. GET READY. YOU'RE NEXT.



LOW PROFILE 3-LAYER HULL

OPEN COCKPIT DESIGN

REMOVABLE ELEMENT SEATING SYSTEM

LIGHTWEIGHT FOR EASY TRANSPORT

AVAILABLE IN FOUR DYNAMIC COLORS

01.6015.0012



FEATURES

- Design incorporates both canoe and kayak characteristics for fun, remarkably easy and natural paddling experience.
- Ideal for both double-bladed and single-bladed paddles.
- Pronounced tumblehome and lower profile for easier paddling.
- 3-layer hull features subtle rocker for straight, smooth tracking.
- Removable Element™ seating system offers enhanced comfort, performance and portaging.

SPECIFICATIONS

LENGTH:	13'
WIDTH:	29"
MATERIAL:	3-Layer Poly

WEIGHT:	59 LBS
SEAT WIDTH:	21"
BOAT CAPACITY:	450 LBS



River



Sheltered



High Performance



Old Town
CANOES KAYAKS

OLD TOWN RECREATIONAL



Canoes



CAMO

OLD TOWN GREEN

OLD TOWN RED

Old Town[®]
CANOES  KAYAKS

OLD TOWN CANOES

Saranac SERIES

We started from scratch with the Saranac family of canoes and developed a model that paddles better than most recreational canoes on the market. The Saranac features two contoured seats with seat backs plus a center bench seat perfect for smaller passengers. The bench also includes a covered storage compartment, while bow and stern seats incorporate a variety of extras including cup holders, rod holders and storage trays designed to add convenience and versatility to the canoe. The Saranac is affordable family fun!



	SARANAC 146	SARANAC 160
Length	14' 6" / 4.4 m	15' / 4.9 m
Width	36" / 91.4 cm	37" / 94 cm
Width at 4" waterline	34.75" / 88.3 cm	34.75" / 88.3 cm
Bow Height	18" / 45.7 cm	18" / 45.7 cm
Depth	13.25" / 33.7 cm	13.5" / 34.2 cm
Weight	79 lbs / 35.8 kg	89 lbs / 40.4 kg
Max load range	700-750 lbs / 317.5 -340.2 kg	800 - 850 lbs / 363.6 - 385.6 kg
Material	Thermoformed polyethylene	Thermoformed polyethylene



[JW0128007651](#)

[JW0128007650](#)



[JW0128008651](#)

[JW0128008650](#)

HULL CHARACTERISTICS

- Bottom** Flat
- Sides** Straight
- Rocker** Moderate

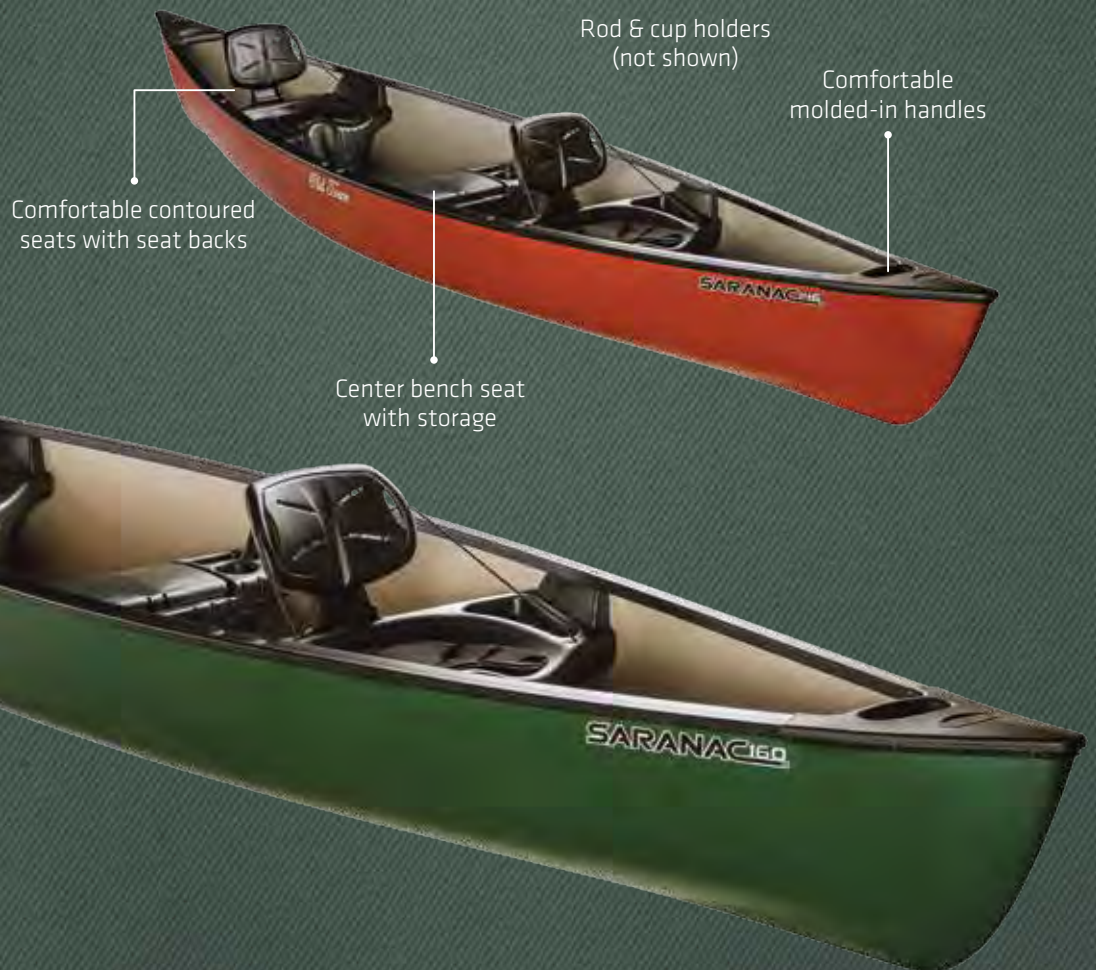

Guide SERIES

The Guide represents a breakthrough in design and construction, ultimately offering a durable, stiff and affordable canoe. Its unique beamy cross-section and stabilizing chines delivers exceptional stability. Its sharp entry provides surprisingly efficient tracking.



GUIDE 147

Length	14' 7" / 4.4 m
Width	38" / 96.5 cm
Width at 4" waterline	36" / 91.4 cm
Bow height	19" / 48.3 cm
Depth	13" / 33 cm
Weight	82 lbs / 37.2 kg
Max load range	850-900 lbs / 385.6-408.2 kg

Material Three layer polyethylene



JW0165010060



JW0165010062

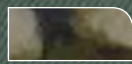

JW0165010064



JW0165000060



JW0165000062

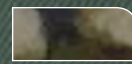

JW0165000064



HULL CHARACTERISTICS

Bottom Shallow Arch
Sides Straight with Chines
Rocker Moderate



Ash yoke

Contoured seats with adjustable backrests

Discovery SERIES

We first started making the Discovery Series in 1984 and over 25 years later they're still renowned for their versatility and durability. Agile, stable and easy to handle, let the Discovery help you explore new territory.

*With a motor, the maximum capacity changes to four persons or 800 pounds as regulated by the U.S. Coast Guard.



	DISCOVERY 119 / 1 SEAT	DISCOVERY 158 / 2 SEATS	DISCOVERY 169 / 2 SEATS
Length	11' 9" / 3.6 m	15' 8" / 4.8 m	16' 9" / 5.1 m
Width	32.5" / 82.6 cm	35.5" / 90.2 cm	37" / 94 cm
Width at 4" waterline	31" / 78.7 cm	35.5" / 90.2 cm	35" / 88.9 cm
Bow height	19" / 48.3 cm	21.5" / 54.6 cm	23" / 58.4 cm
Depth	13.5" / 34.3 cm	13.5" / 34.3 cm	15" / 38.1 cm
Weight	49 lbs / 22.2 kg	87 lbs / 39.5 kg	91 lbs / 41.3 kg
Max load range	450 - 500 lbs / 204.1 - 226.8 kg	1,100 - 1,150 lbs / 499 - 521.6 kg	1,350 - 1,400 lbs / 612.3 - 635 kg
Material	Three layer polyethylene		
	 JW0130010120 JW0130010122	 JW0130050160 JW0130050162	 JW0130080160 JW0130080162
	 JW0130010124	Outfitter: 0130051070 0130051072 JW0130050164	Outfitter: 0130081070 0130081072 JW0130080164

- River
- Touring
- Classic
- Construction
- High Performance

HULL CHARACTERISTICS

- Bottom** Shallow Arch
- Sides** Straight
- Rocker** Moderate

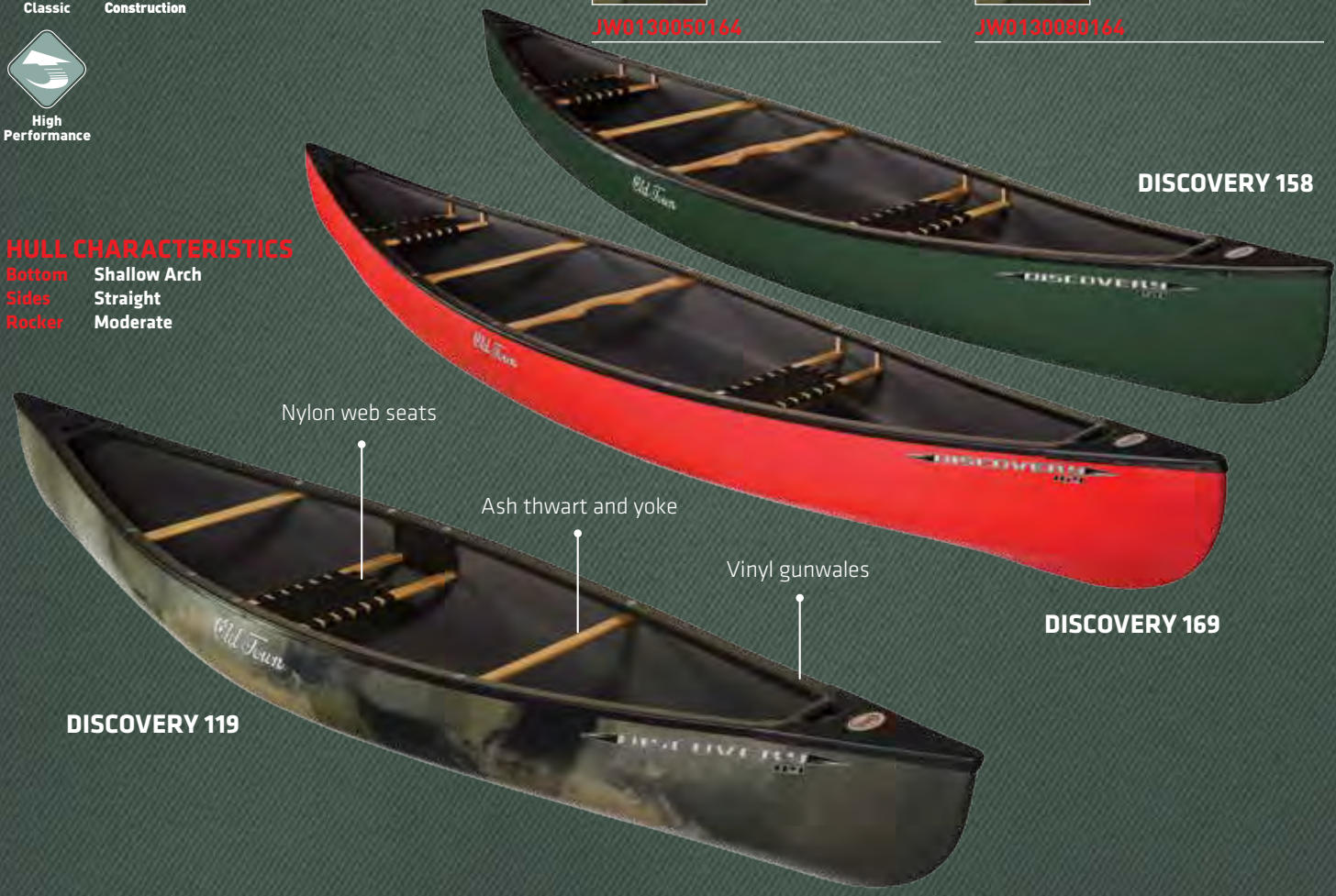

Discovery 133

Back by popular demand! Old Town has updated and re-released the tough, nimble, lightweight and versatile Discovery 133. Paddle it tandem from the nylon web seats at the bow and stern. Paddle or pole it solo. Row it effortlessly from mid-ship oar sockets or from the bow sockets. You can even outfit it with Old Town's motor mount and a small outboard. The patented Discovery 133 delivers wide-bodied steadiness, 3-layer hull construction, a keeled design and plenty of room for coolers, tackle, decoys and other gear. It's the versatile choice for anglers, hunters, nature photographers and more.

Discovery Sport 15

Perfect for sporting activities and recreational family use. Rowed, paddled or motored, it will efficiently glide and maneuver on demand. Designed with full-length stabilizing chines and a generous beam, the dry and confident ride is yours to discover.

DISCOVERY 133 / 3 SEATS

Length	13'3" / 4.0m
Width	40.5 / 1.02m
Width at 4" waterline	39" / 0.99m
Bow height	20.25" / 0.51m
Depth	14" / 0.35m
Weight	78lbs. / 35.38kg
Max load range	800 lbs. / 362.87kg
Material	Three layer polyethylene



DISCOVERY SPORT 15 / 3 SEATS

Length	15' 3" / 4.6 m
Width	40" / 101.6 cm
Width at 4" waterline	39.5" / 100.3 cm
Bow height	25.5" / 64.8 cm
Depth	15" / 38.1 cm
Weight	113 lbs / 51.3 kg
Max load range	1,650 - 1,700 lbs* / 748.4 - 771.1 kg*
Material	Three layer polyethylene

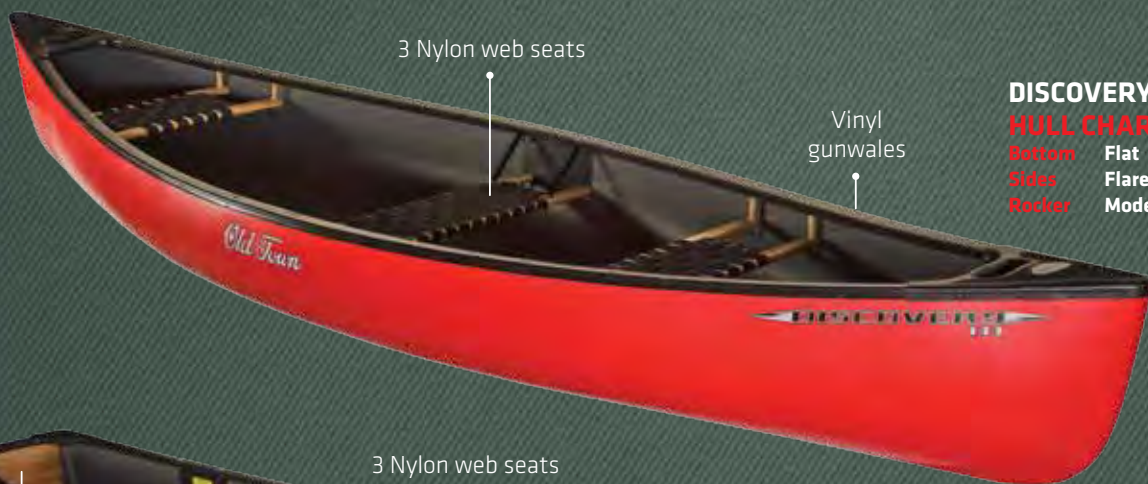
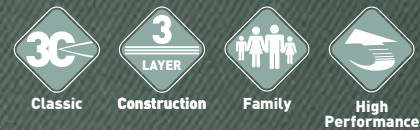

DISCOVERY 133
HULL CHARACTERISTICS
 Bottom Flat
 Sides Flared
 Rocker Moderate

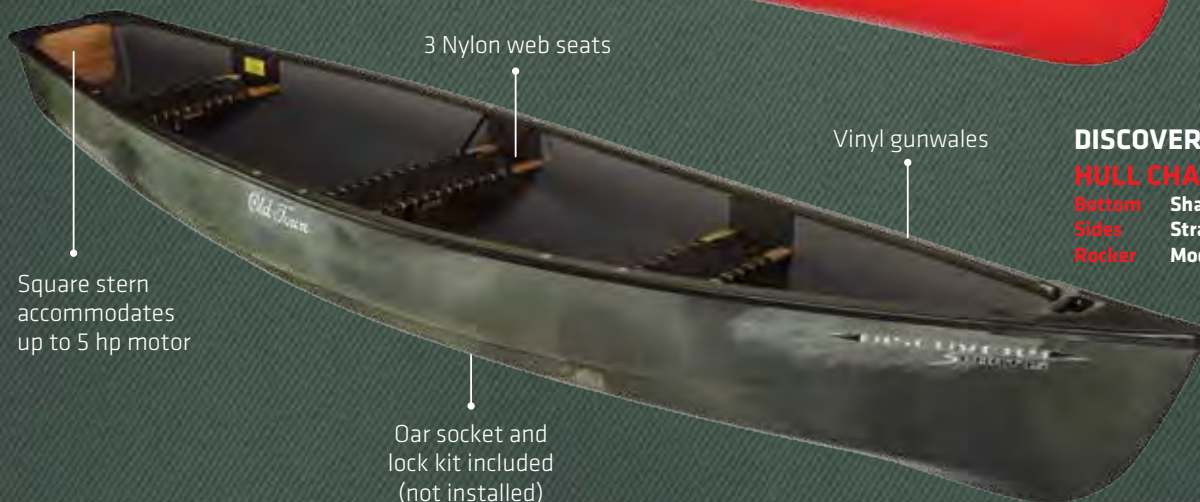

DISCOVERY SPORT 15
HULL CHARACTERISTICS
 Bottom Shallow Arch
 Sides Straight
 Rocker Moderate

Charles River 15

"Very steady, combining beauty in outline with speed and ease of paddling." That's how Old Town's 1903 catalog described our then-new Charles River canoe, and we believe those words ring just as true today. Enjoy this classic design with contemporary materials that provide performance and lightweight durability.

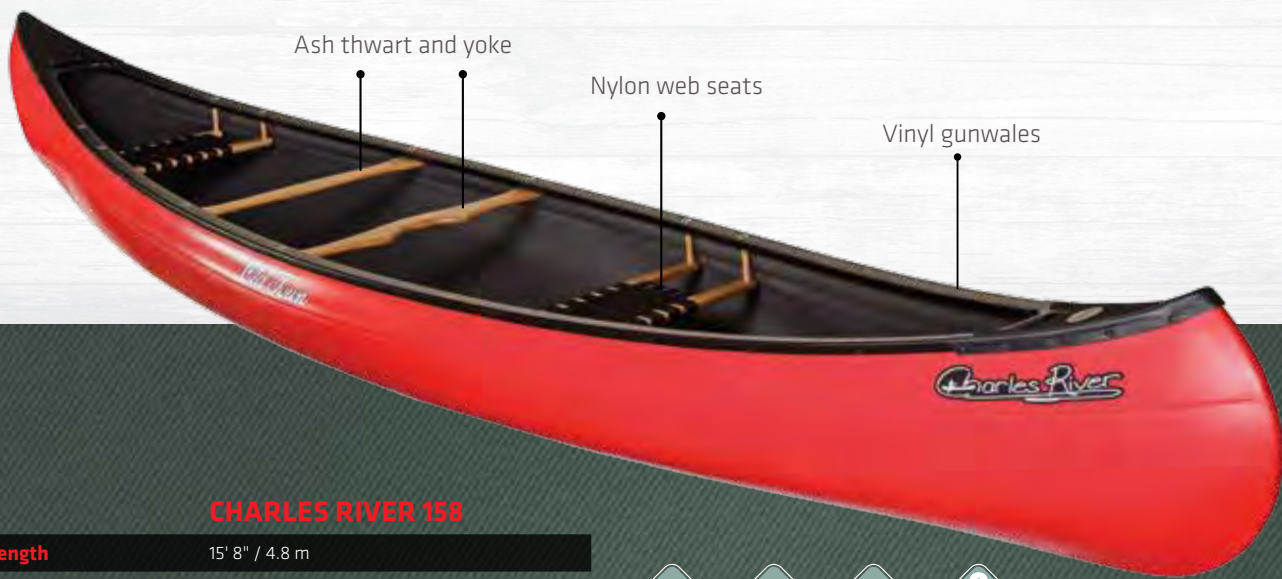

CHARLES RIVER 15

Length	15' 8" / 4.8 m
Width	35" / 88.9 cm
Width at 4" waterline	35.5" / 90.2 cm
Bow Height	24" / 61 cm
Depth	14" / 35.6 cm
Weight	80 lbs / 36.3 kg
Max load range	1,050 - 1,100 lbs / 476.3 - 499 kg
Material	Three layer polyethylene

HULL CHARACTERISTICS

Bottom	Shallow Arch
Sides	Flared with Tumblehome
Rocker	Moderate

Rogue River 154 SS

The Rogue River 154 SS delivers versatility and affordability in one smartly designed canoe. It sports a square stern hull giving you the option to mount a motor when you need to. In addition, the boat features two comfortable contoured seats, molded-in cup holders, a storage hatch and a third center bench seat that doubles as a cooler. With a rugged polyethylene hull, this boat is designed to last.

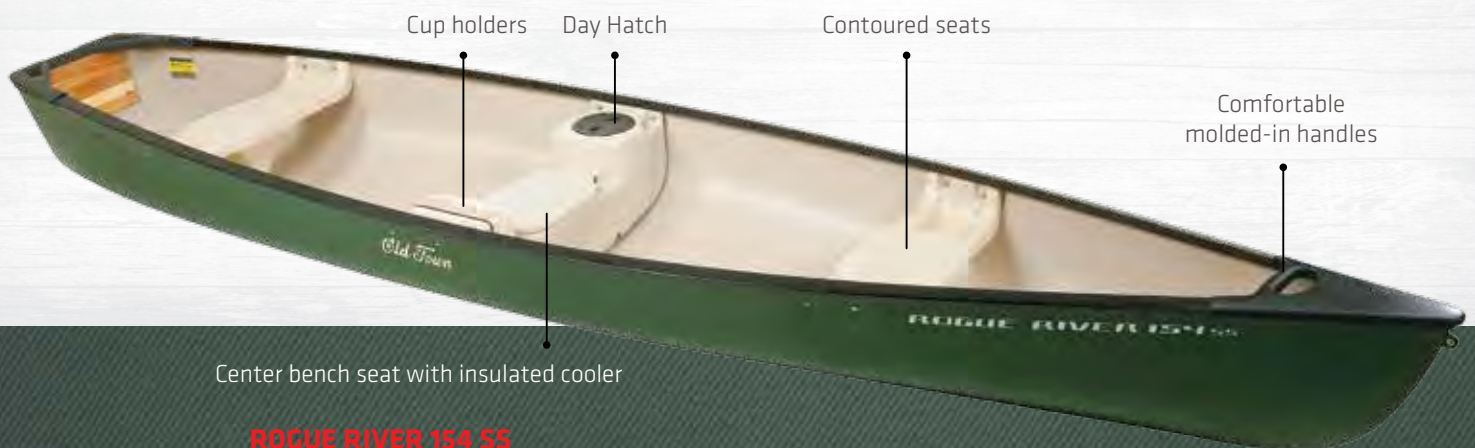

ROGUE RIVER 154 SS

Length	15' 4.5" / 4.7 m
Width	44" / 112.7 cm
Width at 4" waterline	37" / 94 cm
Bow Height	20.5" / 52.1 cm
Depth	15.8" / 40 cm
Weight	118 lbs / 53.5 kg
Max load range	850 lbs* / 385.5 kg*
Material	Thermoformed polyethylene

HULL CHARACTERISTICS

Bottom	Shallow Arch
Sides	Slightly Flared
Rocker	Minimum

Penobscot SERIES

Named after the Native Americans that inhabited Old Town, Maine, since before recorded history – and from whom we’ve gained immeasurable boat-building knowledge – the Penobscot pays homage to their superb craftsmanship, design and navigational skills. The Penobscot’s nearly plumb ends, shallow arch bottom and slight rocker have made it a sleek, nimble tripping canoe for solo or tandem paddlers.

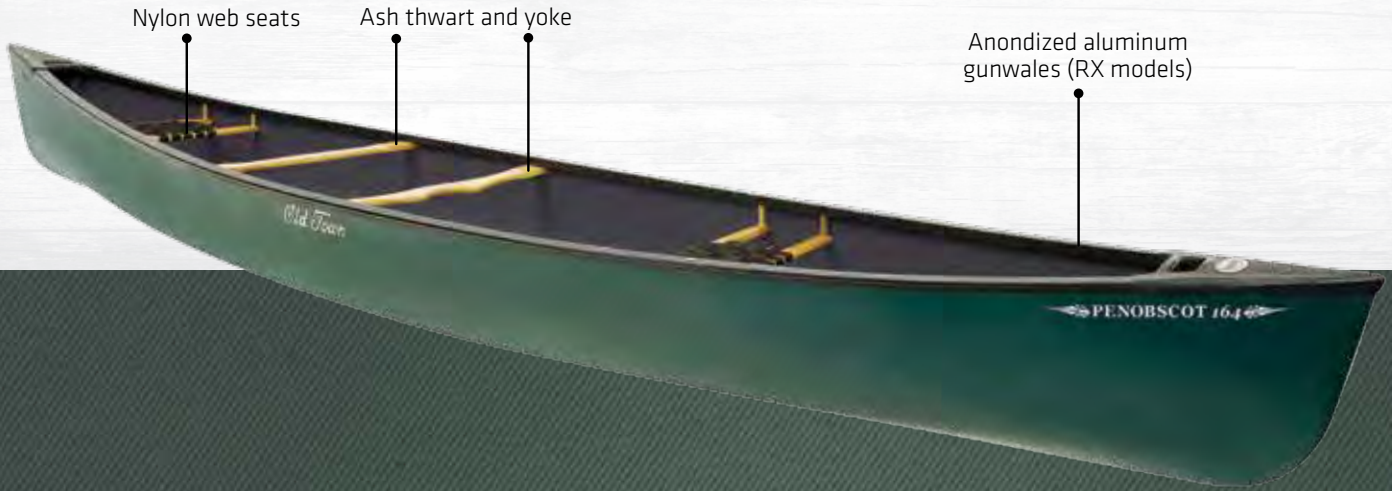

	PENOBSCOT 164	PENOBSCOT 174
Length	16' 4" / 5 m	17' 4" / 5.3 m
Width	37.5" / 95.3 cm	36" / 91.4 cm
Width at 4" waterline	33.75" / 85.7 cm	34" / 86.4 cm
Bow Height	20.25" / 51.4 cm	22" / 55.9 cm
Depth	14" / 35.6 cm	14" / 35.6 cm
Weight	75 lbs / 34 kg	83 lbs / 37.6 kg
Max load range	1,200 - 1,250 lbs / 544.3 - 567 kg	1,450 - 1,500 lbs / 657.7 - 680.4 kg
Material	Three layer polyethylene	Three layer polyethylene



JWD165050160



JWD165050162



JWD165060160



JWD165060162

HULL CHARACTERISTICS

Bottom Shallow Arch
Sides Straight
Rocker Medium



River



Sheltered



Classic



3 LAYER Construction



River



Sheltered



Classic



3 LAYER Construction

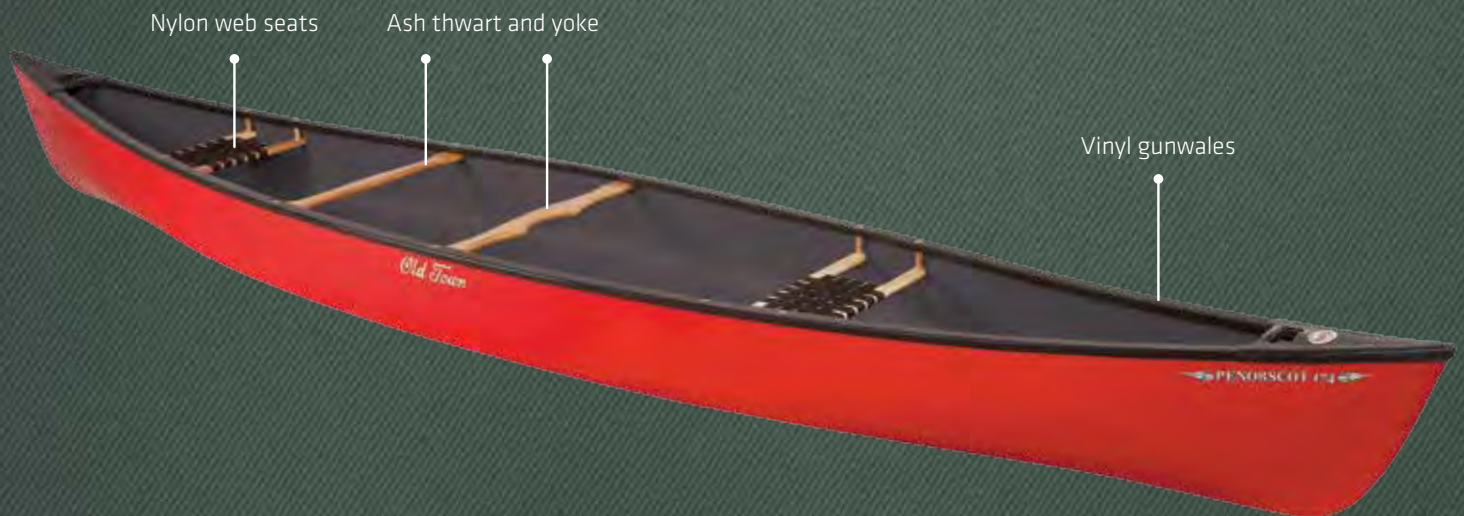

WOOD CANOES



- JW0198030012** Guide 16 Canvas

- JW0198030010** Guide 16 Fiberglass

- JW0198080013** OTCA 16 Canvas

- JW0198080010** OTCA 16 Fiberglass

- JW0198070013** Molitor 17 Canvas

- JW0198070010** Molitor 17 Fiberglass





NECKY KAYAKS

We make travel compelling. Our paddlers are as distinct and different as our many kayaks.
Both become one with a balance of agility, speed, balance and maneuverability.



A PASSION TO PADDLE.



More than 30 years after the first Necky slipped from a quiet cove into the exposed unknown of the Pacific Northwest, our belief in streamlined, elegant, and purpose-built boats remains the core of our approach.

Through design and testing on this wild edge of the continent, we've found that function creates the purest form, and comfort and toughness go hand in hand.

DESIGN & ENGINEERING

Engineering a kayak is a complex proposition. For every performance element gained, another may be diminished. Kayak design is a delicate negotiation that, when done well, minimizes this sort of compromise. The paddler and the water have a say in how a boat performs as well, of course. Each paddler is as distinct as each kayak. The water is an ever-changing medium. So a kayak must be built to come alive and respond to the conditions and possibilities of both.

MATERIALS & TECHNOLOGY

We take our material choices seriously. The heart and soul of a Necky kayak is its bomb-proof, performance hull. Our advanced composite hulls set the high-end standard in the kayak industry, while the remarkably durable Necky polyethylene hulls are second-to-none in design and performance.

From our composite expedition kayaks to our most playful recreational kayaks, every Necky is crafted to optimize the performance not only of the boat, but also the paddler. Find your perfect mate here in our latest product guide. Or visit us on the World Wide Web, and discover a whole new world to explore.



RIP SERIES

The Rip family is designed to encourage paddling skills without sacrificing fun on the water. NEW for 2014 is a built in drop down skeg making the RIP both agile and maneuverable, but also a great straight tracking,

touring boat as well. And Necky put many of the best characteristics of our high-end sea kayaks into the Rip series hulls. Lively and playful on the water, the Rip won't disappoint.

RIP 10™ Drop Skeg

POLYMER



Skeg shown in the down position

BULKHEAD:	Stern
LENGTH:	10' 6" (3.2 m)
WIDTH:	28.5" (72.4 cm)
WEIGHT:	43 lbs. (19.5 kg)
COCKPIT:	46.5" x 19.5" (118.1 x 49.5 cm)
STORAGE:	64.2 L (3918 cu. in.)

SEAT: ACS2 **THIGH PADS:** Custom Foam Pads **HATCHES:** Stern: 16.5" x 10.5" (41.9 x 26.7 cm)



JW0776601102



JW0776601104



JW0776601106



JW0776601100

RIP 12™ Drop Skeg

POLYMER



BULKHEAD:	Stern
LENGTH:	12' (3.66 m)
WIDTH:	28" (71.1 cm)
WEIGHT:	49 lbs. (22.2 kg)
COCKPIT:	46.25" x 19.5" (117.5 x 49.5 cm)
STORAGE:	64.2 L (3918 cu. in.)

SEAT: ACS2 **THIGH PADS:** Custom Foam Pads **HATCHES:** Stern: 16.5" x 10.5" (41.9 x 26.7 cm)



JW0776581102



JW0776581104



JW0776581106



JW0776581100



ELIZA SERIES

Designed to fit and perform for smaller paddlers (up to 150 lbs.). The low aft deck offers optimum room for sculling, rolling, surf ability, and bracing. Designed from the start with an exceptional balance of glide, maneuverability and reduced drag from frictional

resistance and wind. The Eliza is the best kayak on the market to paddle efficiently, with less effort, less resistance, and less energy.

ELIZA™ POLYMER



INCLUDES: Rudder System

SEAT: Necky Touring Seat with Backband **THIGH BRACES:** Comfort Fit™ **HATCHES:** Bow and Stern: 14" x 7.5" (35.6 x 19.1 cm)



JW0775201040



JW0775201030



JW0775201055



JW0775201085



Touring

BULKHEAD: Bow, Stern

LENGTH: 15' 3.5" (4.7 m)

WIDTH: 22" (55.8 cm)

WEIGHT: 50 lbs. (22.7 kg)

COCKPIT: 28.25" x 16"

(71.6 x 40.6 cm)

STORAGE: 124.9 L (7622 cu. in.)

ELIZA™ DROP SKEG - FG

COMPOSITE



INCLUDES: Retractable Skeg

SEAT: Necky Touring Seat with Backband **THIGH BRACES:** Composite **HATCHES:** Bow and Stern: 16" x 9" (40.6 x 22.9 cm)



JW0780171709



JW0780171609



Touring

BULKHEAD: Bow, Stern

LENGTH: 15' 3" (4.7 m)

WIDTH: 21" (53.3 cm)

WEIGHT: FG: 45 lbs. (20.4 kg)

C: 41 lbs. (18.6kg)

COCKPIT: 28.5" x 15"

(72.4 x 38.1 cm)

STORAGE: 136.2 L (8311 cu. in.)

ELIZA™ RUDDER - FG

COMPOSITE



INCLUDES: Rudder System

SEAT: Necky Touring Seat with Backband **THIGH BRACES:** Composite **HATCHES:** Bow and Stern: 16" x 9" (40.6 x 22.9 cm)



JW0780171500



JW0780171510



Touring

BULKHEAD: Bow, Stern

LENGTH: 15' 3" (4.7 m)

WIDTH: 21" (53.3 cm)

WEIGHT: FG: 45 lbs. (20.4 kg)

C: 41 lbs. (18.6kg)

COCKPIT: 28.5" x 15"

(72.4 x 38.1 cm)

STORAGE: 136.2 L (8311 cu. in.)



MANITOU SERIES

If there was one type of kayak that could meld sea touring hull design with the stability and comfort of a recreational kayak, the Manitou series is it. These super sleek, clean-lined kayaks have an

integral keel which provides the new or experienced paddler an outstanding blend of tracking, balance and maneuverability, even in windy conditions. The Manitous have amazingly quiet glide, and high volume

MANITOU SPORT™

POLYMER



SEAT: ACS2 THIGH PADS: Foam Thigh Pads HATCHES: Stern: 16.5" x 10.5" (41.9 x 26.7 cm)



JW0774650156



JW0774650150



JW0774650152



JW0774650154



Touring

BULKHEAD: Stern

LENGTH: 10' 11" (3.3 m)

WIDTH: 26.5" (67.3 cm)

WEIGHT: 43 lbs. (19.5 kg)

COCKPIT: 42" x 20.5"

(106.7 x 52.1 cm)

STORAGE: 61.8 L (3771 cu. in.)

MANITOU 13™

POLYMER



SEAT: ACS2 THIGH PADS: Foam Thigh Pads HATCHES: Stern: 16.5" x 10.5" (41.9 x 26.7 cm)



JW0776250156



JW0776250150



JW0776250152



JW0776250154



Touring

BULKHEAD: Stern

LENGTH: 12' 10.5" (3.9 m)

WIDTH: 24.75" (62.9 cm)

WEIGHT: 46 lbs. (20.9 kg)

COCKPIT: 34.5" x 16.25"

(87.6 x 41.3 cm)

STORAGE: 64.4 L (3930 cu. in.)

MANITOU 130 R™

POLYMER

07.7810.1056

07.7810.1050

07.7810.1052

07.7810.1054

INCLUDES: Rudder System



SEAT: ACS2 THIGH PADS: Foam Thigh Pads HATCHES: Bow: 14" x 7.5" (35.6 x 19.1 cm); Stern: 16.5" x 10.5" (41.9 x 26.7 cm)



JW0778100156



JW0778100150



JW0778100152



JW0778100154



Touring

BULKHEAD: Bow, Stern

LENGTH: 13' 1" (4 m)

WIDTH: 25" (63.5 cm)

WEIGHT: 50 lbs. (22.7 kg)

COCKPIT: 34.5" x 16" (87.6 x 40.6 cm)

STORAGE: 122.9 L (7499 cu. in.)

MANITOU 14™

POLYMER

INCLUDES: Retractable Skeg



SEAT: ACS2 THIGH BRACES: Comfort Fit™ HATCHES: Bow: 14" x 7.5" (35.6 x 19.1 cm); Stern: 16.5" x 10.5" (41.9 x 26.7 cm)



JW0776350156



JW0776350150



JW0776350152



JW0776350154



Touring



High Performance

BULKHEAD: Bow, Stern

LENGTH: 14' 4" (4.4 m)

WIDTH: 24" (61 cm)

WEIGHT: 52 lbs. (23.6 kg)

COCKPIT: 35.5" x 16.5"

(90.2 x 41.9 cm)

STORAGE: 113.6 L (6932 cu. in.)

bows for drier rides in rough water and added sense of security. Equipped with features like the Active Comfort System (ACS) seat and Quick Seal Hatch with bulkhead, these kayaks are at home on a calm lake or rough coastline.

MANITOU II™

POLYMER



INCLUDES: Kid's Jump Seat **SEAT:** ACS **FOOT BRACES:** Support Track **HATCHES:** Stern: 16.5" x 10.5" (41.9 x 26.7 cm)



JW0775100150



JW0775101010



Touring

BULKHEAD: Stern

LENGTH: 14' 8" (4.5 m)

WIDTH: 28" (71.1 cm)

WEIGHT: 79 lbs. (35.8 kg)

COCKPIT: Stern: 48.5" x 18"

(123.2 x 45.7 cm)

Bow: 35" x 17"

(88.9 x 43.2 cm)

STORAGE: 63.5 L (3880 cu. in.)

MANITOU II R™

POLYMER



INCLUDES: Rudder System, Kid's Jump Seat **SEAT:** ACS **FOOT BRACES:** Support Track

HATCHES: Stern: 16.5" x 10.5" (41.9 x 26.7 cm)



JW0775100154



JW0775100156



Touring

BULKHEAD: Stern

LENGTH: 14' 8" (4.5 m)

WIDTH: 28" (71.1 cm)

WEIGHT: 79 lbs. (35.8 kg)

COCKPIT: Stern: 48.5" x 18"

(123.2 x 45.7 cm)

Bow: 35" x 17"

(88.9 x 43.2 cm)

STORAGE: 63.5 L (3880 cu. in.)



LOOKSHA SERIES

The Looksha's are outstanding sea touring kayaks with excellent tracking, performance, glide and overall handling characteristics. From the San Juan Islands

to Nova Scotia, the Looksha's are designed to carry a huge load, handle rough water and go the distance with efficiency and ease.

LOOKSHA 12™

POLYMER



OPTIONS: Rudder System

SEAT: ACS2 THIGH BRACES: Comfort Fit™ HATCHES: Bow: 14" x 7.5" (35.6 x 19.1 cm); Stern: 16.5" x 10.5" (41.9 x 26.7 cm)

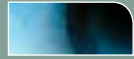

JW0775900156



JW0775900150



JW0775900152



JW0775900154



Touring

BULKHEAD: Bow, Stern

LENGTH: 12' 1" (3.7 m)

WIDTH: 25.5" (64.8 cm)

WEIGHT: 48 lbs. (21.8 kg)

COCKPIT: 36" x 16.75"

(91.4 x 42.5 cm)

STORAGE: 124.9 L (7622 cu. in.)

LOOKSHA 14™

POLYMER

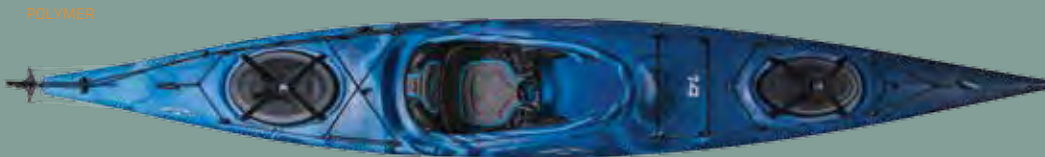

INCLUDES: Rudder System

SEAT: ACS2 THIGH BRACES: Comfort Fit™ HATCHES: Bow: 14" x 7.5" (35.6 x 19.1 cm); Stern: 16.5" x 10.5" (41.9 x 26.7 cm)

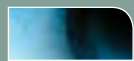

JW07749001566



JW0774900160



JW0774900162



JW0774900164



Touring

BULKHEAD: Bow, Stern

LENGTH: 14' 1.5" (4.3 m)

WIDTH: 24.5" (62.3 cm)

WEIGHT: 54 lbs. (24.5 kg)

COCKPIT: 35.5" x 16.5"

(90.2 x 41.9 cm)

STORAGE: 162.8 L (9935 cu. in.)

LOOKSHA 17™

POLYMER



INCLUDES: Rudder System SEAT: ACS2 THIGH BRACES: Adjustable

HATCHES: Bow and Stern: 16.5" x 10.5" (41.9 x 26.7 cm)



JW0775601070



JW0775601072



Touring

BULKHEAD: Bow, Stern

LENGTH: 17' 4" (5.3 m)

WIDTH: 23.75" (60.3 cm)

WEIGHT: 68 lbs. (30.8 kg)

COCKPIT: 33" x 17.25"

(83.8 x 43.8 cm)

STORAGE: 189.3 L (11,552 cu. in.)

LOOKSHA 17™ - FG - C

COMPOSITE



INCLUDES: Rudder System SEAT: ACS2 THIGH BRACES: Composite

HATCHES: Bow and Stern: 16.5" x 10" (41.9 x 25.4 cm)



JW0780201702



JW0780201602



JW0780242450



Touring

BULKHEAD: Bow, Stern

LENGTH: 17' 6" (4.4 m)

WIDTH: 23.75" (60.3 cm)

WEIGHT: FG: 54 lbs. (24.4kg)

C: 49lbs. (22.2kg)

COCKPIT: 33" x 17" (83.8 x 43.2 cm)

STORAGE: 196.9 L (12,016 cu. in.)



LOOKSHA ELITE™

COMPOSITE

INCLUDES: Smart TrackControl System with Rudder



SEAT: Necky Touring Seat with Backband **THIGH BRACES:** Composite

HATCHES: Bow and Stern: 16.5" x 10" (41.9 x 25.4 cm)



JW0780261702



JW0780261602



JW0780262450



Touring

BULKHEAD: Bow, Stern

LENGTH: 17' (5.2 m)

WIDTH: 22" (55.9 cm)

WEIGHT: FG: 52 lbs. (23.6kg)

C: 47lbs. (21.3kg)

COCKPIT: 32" x 16" (81.3 x 40.6 cm)

STORAGE: 201 L (12,266 cu. in.)

LOOKSHA T™

POLYMER TARBULEX

INCLUDES: Rudder System



SEAT: Cushion Seat with Removable Pedestal **THIGH BRACES:** Comfort Fit

BOW AND STERN: 16.5" x 10.5" (41.9 x 26.7 cm)



JW0775801070



JW0775801040



Touring

BULKHEAD: Bow, Stern

LENGTH: 18' 1" (5.5 m)

WIDTH: 30" (76.2 cm)

WEIGHT: 96 lbs. (43.5 kg)

COCKPIT: 35.5" x 17.3"

(90.2 x 43.8 cm)

STORAGE: 190 L (11,595 cu. in.)



ELIAS SERIES

A lively, responsive touring kayak, the Elias takes its design cues from the popular Eliza kayak, bringing a slightly longer and larger model to market that appeals to a broad variety of paddlers. A playful and comfortable craft, the Elias offers a performance fit cockpit that enables paddlers to 'grip' the boat for

edging and lean turning while still maintaining an easy feel for the more casual paddler. Good primary stability and excellent secondary stability combine with the platform's proven low and balanced windage design to give the Elias an assuring, confident ride in even the most challenging conditions.

ELIAS™ POLYMER

INCLUDES: Rudder System



SEAT: Necky Touring with Backband THIGH BRACES: Comfort Fit™
HATCHES: Bow: 14" x 7.5" (35.6 x 19.1 cm); Stern: 16.5" x 10.5" (41.9 x 26.7 cm)



JW0778300146



JW0778301030



JW0778300111



JW0778300154



Touring

BULKHEAD:	Bow, Stern
LENGTH:	15' 6" (4.7 m)
WIDTH:	22.25" (56.5 cm)
WEIGHT:	56 lbs. (25.4 kg)
COCKPIT:	32.25" x 16" (81.9 x 40.6 cm)
STORAGE:	199.2 L (12,155 cu. in.)

ELIAS™ DROP SKEG COMPOSITE

INCLUDES: Retractable Skeg



SEAT: Necky Touring with Backband THIGH BRACES: Composite HATCHES: Bow and Stern: 16" x 9" (40.6 x 22.9 cm)



JW0780280001



JW0780280002



Touring

BULKHEAD:	Bow, Stern
LENGTH:	15' 6" (4.7 m)
WIDTH:	22.25" (56.5 cm)
WEIGHT:	FG: 47 lbs. (21.3 kg) C: 43 lbs. (19.5 kg)
COCKPIT:	32.25" x 16" (81.9 x 40.6 cm)
STORAGE:	199.2 L (12,155 cu. in.)

CHATHAM SERIES

Greenland-inspired coastal play boats built to tame the biggest conditions - high winds, surf, and tidal races. Their hard chined/soft edged hulls offer the ultimate in stability and handling on edge to dig in and out of rock gardens or taking that unexpected wave. Our design team thought of everything from offering outstanding neutrality in wind to help reduce

weather-cocking to placing the recessed compass mount in a location that reduces sea sickness. Equally at home on Vancouver's West Coast, playing in the 8+ knot currents of Deception Pass, or camping along the Maine Island Trail, Chathams are the ultimate performers in rough water conditions where high wind and rough seas prevail.

CHATHAM 16™ COMPOSITE

INCLUDES: Retractable Skeg



SEAT: Necky Touring Seat with Backband THIGH BRACES: Adjustable HATCHES: Bow and Stern: 16" x 9" (40.6 x 22.9 cm); Day: 7.5" (19 cm)



JW07800211701



JW0780011601



JW0780012450



Coastal



Touring

BULKHEAD:	Bow, Stern
LENGTH:	16' 5" (5 m)
WIDTH:	22" (55.8 cm)
WEIGHT:	FG: 51 lbs. (23.1 kg) C: 46 lbs. (20.8 kg)
COCKPIT:	30.75" x 14.25" (78.1 x 36.2 cm)
STORAGE:	143.8 L (8775 cu. in.)

CHATHAM 17™ COMPOSITE

INCLUDES: Retractable Skeg



SEAT: Necky Touring Seat with Backband THIGH BRACES: Adjustable HATCHES: Bow and Stern: 16" x 9" (40.6 x 22.9 cm); Day: 7.5" (19 cm)



JW0780021701



JW0780021601



JW0780022450



Coastal



Touring

BULKHEAD:	Bow, Stern
LENGTH:	17' 4.5" (5.3 m)
WIDTH:	21.5" (54.6 cm)
WEIGHT:	FG: 52 lbs. (23.6 kg) C: 47 lbs. (21.3 kg)
COCKPIT:	32" x 16" (81.3 x 40.6 cm)
STORAGE:	166.6 L (10,167 cu. in.)



KAYAK PADDLES

KIDS



SABER

A great kayak paddle for kids! Short and sweet, the Saber is lightweight and kid proof. This durable paddle is sized down making it a nice option for small hands to grip and maneuver.

BLADE MATERIAL	SHAFT MATERIAL	LENGTH (cm)	WEIGHT
polypropylene	aluminum	190	31 oz.
Sunrise	JW0125093755		
Cloud	JW0125093750		

ADULTS



VALUE KAYAK PADDLE

The Value Kayak Paddle has symmetric polyethylene blades and a durable aluminum shaft. Ergonomic foam grips are included. This is a great paddle for beginners or for use as a spare. The push-button takedown allows blades to be feathered at 60° or set inline.

BLADE MATERIAL	SHAFT MATERIAL	LENGTH (cm)	WEIGHT
polyethylene	aluminum	240	42 oz.
Black	JW0113322600		



BLADE COLOURS SHAFT COLOUR

DAY TRIPPER

Tried and true the Day Tripper is one of our most popular paddles. A lightweight anodized aluminum shaft is ovalized for easy gripping. This is the paddle of choice for beginners, or for use as a backup. A push-button takedown allows blades to be feathered at 60 degrees or inline, for right- and left-hand control. Also available in a 1-piece paddle option. *Yellow blade color available in 230 cm only.

BLADE MATERIAL	SHAFT MATERIAL	LENGTHS (cm)	WEIGHT
glass reinforced polypropylene	anodized aluminum	1-piece: 220, 230 2-piece: 220, 230*, 240	37 oz. (220 cm)
Black		220cm JW0113325779 (1 Piece)	230cm JW0113325580 (1 Piece)
		JW0125570820 (2 Piece)	240cm JW012557.0840 (2 Piece)
Yellow		JW0125093625	JW0113325780 (2 Piece)



BLADE COLOURS SHAFT COLOUR

MAGIC MYSTIC

Durable aluminum shaft makes the Magic Mystic a reliable introductory paddle. Fiberglass reinforced polypropylene blades are efficiently designed to offer impressive power when on the water.

BLADE MATERIAL	SHAFT MATERIAL	LENGTHS (cm)	WEIGHT
glass reinforced polypropylene	anodized aluminum Fiberglass Ferrules	220, 230, 240	39.5 oz. (220 cm)
Cloud		220cm JW0125093492	230cm JW0125093493
Sunrise		JW0125093489	240cm JW0125093494
Limon		JW0125093870	JW0125093491
			JW0125093880



BLADE COLOURS SHAFT COLOUR

MAGIC

The Magic features fiberglass reinforced nylon blades providing a slightly stiffer yet very efficient stroke that is further supported by our aluminum shaft. For paddlers that need a bit more strength and durability from their paddle, the Magic is the paddle of choice.

BLADE MATERIAL	SHAFT MATERIAL	LENGTHS (cm)	WEIGHT
glass reinforced nylon	anodized aluminum Fiberglass Ferrules	220, 230, 240	38.8 oz. (220 cm)
Dark Grey		220cm JW0125093545	230cm JW0125093550
Periwinkle		JW0125093515	240cm JW0125093555
Yellow		JW0125093885	JW0125093525
			JW0125093895

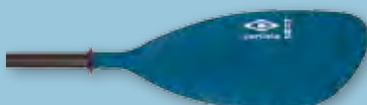

BLADE COLOURS SHAFT COLOUR

NEXT

Fiberglass reinforced polypropylene blades in bright colors are lightweight and durable. The asymmetrical, slightly curved blade shape combined with a lightweight, flexible fiberglass shaft produces smooth yet powerful strokes.

BLADE MATERIAL	SHAFT MATERIAL	LENGTHS (cm)	WEIGHT
glass reinforced polypropylene	wrapped fiberglass	220, 230, 240, 250, 260	39.8 oz. (220 cm)
Blue		220cm 0125093633	230cm JW0125093634
Lemongrass		0125093627	240cm JW0125093615
Purple		0125093631	250 JW0125093616
Sunrise		0125093629	260 JW0125093617
			JW0125093608
			JW0125093614
			JW0125093611



BLADE COLOURS SHAFT COLOUR

MAGIC PLUS

The Magic Plus features fiberglass reinforced polypropylene blades in bright colors. The asymmetrical blade shape combined with a flexible fiberglass shaft produces smooth yet powerful strokes. Lightweight and durable.

BLADE MATERIAL	SHAFT MATERIAL	LENGTHS (cm)	WEIGHT
glass reinforced polypropylene	wrapped fiberglass Fiberglass Ferrules	220, 230, 240	39.8 oz. (220 cm)
Cloud		220cm JW0125093675	230cm JW0125093680
Sunrise		JW0125093660	240cm JW0125093685
Dark Cherry		JW0125093900	JW0125093670
			JW0125093910



PREDATOR ANGLER

Fiberglass reinforced polypropylene blades in new tactical and urban camo patterns are very lightweight and highly durable. The asymmetrical, slightly curved blade shape combined with a lightweight, flexible fiberglass shaft produces smooth, yet powerful strokes. Incorporated into the blade is a hook-notch designed to make quick work of retrieving hard to reach snagged lines, hooks and lures.

	BLADE MATERIAL	SHAFT MATERIAL	LENGTHS (cm)	WEIGHT
	glass reinforced polypropylene	wrapped fiberglass	220, 230, 240, 250	39.8 oz. (220 cm)
Camo	220cm JW0125093626	230cm JW0125093603	240cm JW0125093604	250cm JW0125093605
Urban Camo	JW0125093625	JW0125093600	JW0125093601	JW0125093602
Lime Camo	JW0125093596	JW0125093597	JW0125093598	JW0125093599



EXPEDITION ANGLER

Anglers, this one is for you. The Expedition Angler is a painted fiberglass paddle that is durable yet extremely lightweight - making it easier to get to the fishing spot and leaving you with plenty of energy to land the big one.

	BLADE MATERIAL	SHAFT MATERIAL	LENGTHS (cm)	WEIGHT
	fiberglass	fiberglass	220, 230, 240	34 oz. (220 cm)
Olive	220cm JW0125660420	230cm JW0125660430	240cm JW0125660440	



EXPEDITION

This fiberglass paddle is the perfect partner on your next kayak expedition. Easy on the arms, this fiberglass paddle can be feathered at 60 degrees or set inline. A great pick for day touring or longer distance paddling.

	BLADE MATERIAL	SHAFT MATERIAL	LENGTHS (cm)	WEIGHT
	fiberglass	fiberglass	220, 230, 240	33 oz. (220 cm)
Yellow	220cm JW0125660220	230cm JW0125660230	240cm JW0125660240	



PUSH POLE

This kayak push pole is a must for discriminating flats/shallow water fishermen. Sold as a 2-piece break-down for convenience, this pole also has durable ferrules, pointy stake end and custom wide foot to work in all water and bottom conditions. Available in Aluminum or Composite shaft.

	SHAFT MATERIAL	LENGTHS (in.)	WEIGHT
	aluminum	120	28 oz.
	composite		24 oz.
Black	ALUMINIUM JW0125093620 (2 Piece)	COMPOSITE JW0125093621 (2 Piece)	





VALUE CANOE PADDLE

The Value Canoe Paddle has a durable aluminum shaft and a polyethylene blade with T-grip. A great paddle for beginners or for use as a spare.



BLADE MATERIAL	SHAFT MATERIAL	LENGTH (in.)	WEIGHT
polyethylene	aluminum	54	24 oz.

Black	Value Canoe Paddle 54 JW0113322601	Canoe Paddle Telescoping 42" - 72" JW0113322604	 
			BLADE COLOURS SHAFT COLOUR

ECONOMY

Lightweight and durable, this is the perfect all-purpose paddle. An 8" x 20" blade adds power to your stroke. Blade and T-grip are molded of high impact polypropylene. *Yellow and red option available in 60" length only.



BLADE MATERIAL	SHAFT MATERIAL	LENGTHS (in.)	WEIGHT
high impact polypropylene	aluminum	black: 48, 51, 54, 57, 60, 63, 66 green: 48, 54, 57, 60*, 66	30 oz. (60 in.)

	Tgrip 48	Tgrip 51	Tgrip 54	Tgrip 57	Tgrip 60	Tgrip 63	Tgrip 66
Black	JW0113322555	JW0125130010	JW0113322552	JW0113322553	JW0113322554	JW0113322558	JW0125130060
Green	JW0125139870	-	JW0125139820	JW0125139860	JW0125139840	-	JW0125139850
Red	-	-	-	-	JW0125134840	-	-
Yellow	-	-	-	-	JW0125135840	-	-



TREKKER

Our bent-shaft Trekker with a slightly cupped blade gives you more power with less effort on every stroke. It's all about efficiency. The aluminum construction is lightweight, the foam grip is easy on the hands, and the 14 degree angle is optimized to clear the bow and slide into the water... and at the price, you won't find a better value, period.



BLADE MATERIAL	SHAFT MATERIAL	LENGTHS (in.)	WEIGHT
glass reinforced nylon	anodized aluminum	48, 50, 52, 54	26.5 oz. (48 in.)

	48	50	52	54
Green	JW0113322694	JW0113322691	JW0113322692	JW0113322693
Black	JW0113322699	JW0113322696	JW0113322697	JW0113322698



STANDARD

The industry standard for strength and durability. A fully clad aluminum shaft provides power and reduces maintenance.



BLADE MATERIAL	SHAFT MATERIAL	LENGTHS (in.)	WEIGHT
high impact polypropylene	aluminum with polyethylene grip	54 (black, green, olive, yellow/blue); 57, 60 (all colors); 63 (black only)	34 oz. (60 in.)

	Tgrip 54	Tgrip 57	Tgrip 60	Tgrip 63
Black/Black	JW0125158820	JW0125158830	JW0125158840	JW0125158850
Green/Green	JW0125159920	JW0125159930	JW0125159940	-
Olive/Olive	JW0125150020	JW0125150030	JW0125150040	-
Yellow/Blue	JW0113322900	JW0113322901	JW0113322902	-
White/Blue	-	JW0125153230	JW0125153240	-
White/Red	-	JW0125153430	JW0125153440	-
Yellow/Red	-	JW0125155430	JW0125155440	-





GOLDENLIGHT

The gold aluminum shaft is not only eye-catching, the Goldenlight is an ideal multi-use paddle. T-Grip and a foam shaft grip make it comfortable and less likely to slip in use.

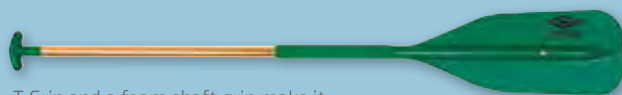

BLADE MATERIAL	SHAFT MATERIAL	LENGTHS (in.)	WEIGHT
high impact polypropylene	aluminum	51 (black only), 54, 57, 60	30 oz. (60 in.)

	Tgrip 51	Tgrip 54	Tgrip 57	Tgrip 60
Black	JW0113322694	JW0113322510	JW0113322515	JW0113322520
Green	-	JW0113322511	JW0113322516	JW0113322521



TELESCOPING HOOK/PADDLE

This collapsible paddle stores easily and makes a great backup paddle for canoes or motorboats. The unique hook on the end is designed for grabbing docks, boats or the closest tree.



BLADE MATERIAL	SHAFT MATERIAL	LENGTHS (in.)	WEIGHT
polyethylene	aluminum	extends from 42" to 72"	20 oz.

Black	Canoe Paddle Telescoping 42" - 72" JW0113322604
--------------	---



AUSABLE

A durable, inexpensive, utility grade laminated paddle. Excellent for beginners or as a spare. The 36" and 42" size are perfect for kids.



BLADE MATERIAL	SHAFT MATERIAL	LENGTHS (in.)	WEIGHT
basswood	basswood	36, 42, 48, 54, 60, 66, 72	28 oz. (60 in.)

	Youth 36	Youth 42	48	54	60	66	72
Wood	JW0125101360	JW0125101420	JW0125101480	JW0125101540	JW0125101600	JW0125101660	JW0125101720



BEAVERTAIL

This lightweight, laminated, basswood paddle features a urethane tip guard at one end and a hand-contoured grip at the other. An ergonomically-designed shaft and 8" beavertail blade shape combine for easy paddling.



BLADE MATERIAL	SHAFT MATERIAL	LENGTHS (in.)	WEIGHT
basswood	basswood	54, 57, 60, 63	23 oz. (60 in.)

	54	57	60	63
Wood	JW0113322438	JW0113322439	JW0113322440	JW0113322441



SCOUT

The Scout's blade design and lightweight wood provide a powerful stroke. This basswood paddle features a blade urethane tip guard and a contoured grip for ease of control.



BLADE MATERIAL	SHAFT MATERIAL	LENGTHS (in.)	WEIGHT
basswood	basswood	54, 57, 60, 63	23 oz. (60 in.)

	54	57	60	63
Wood	JW0113322486	JW0113322489	JW0113322487	JW0113322476





WOOD ECONOMY

The Wood Economy is made from durable laminated wood and sealed with water-resistant urethane.

BLADE MATERIAL	SHAFT MATERIAL	LENGTHS (ft.)	WEIGHT
wood	wood	5, 5.5, 6, 6.5, 7	52 oz. (5 ft.)



Wood	5	5.5	6	6.5	7
	JW0125103500	JW0125103550	JW0125103600	JW0125103650	JW0125103700

ECONOMY BOAT OAR

The Economy Boat Oar shaft is made of lightweight aluminum and runs the full length of the blade to ensure maximum strength and durability.

A 5.5" x 26" blade delivers superior power and a contoured handle makes maneuvering easy.



BLADE MATERIAL	SHAFT MATERIAL	LENGTHS (ft.)	WEIGHT
high impact polypropylene	aluminum	1-piece (see online for color options): 5.5, 6, 6.5, 7 2-piece (olive only): 6, 6.5, 7	38 oz. (5.5 ft.)

	5.5	6	6.5	7	TD 6	TD 6.5	TD 7
Black	JW0125191210	-	JW0125191230	JW0125191240	-	-	-
Olive	-	JW0125191120	JW0125191130	JW0125191140	JW0125192120	JW0125192130	JW0125192140
Silver	-	JW0125191020	JW0125191030	JW0125191040	-	-	-

EXTRA HEAVY DUTY SHAFT

A tempered aluminum full-length shaft and reinforced inner sleeve maximize strength and stiffness. A contoured handle with a Santoprene grip ensures comfort. Heavy duty takedown option is available in blue 9' and 10' lengths. NOTE: Shaft measurements listed below include a 26" blade. Blades available in 6.5" x 26" or 8" x 26". Yellow or black. *Blades sold separately.*

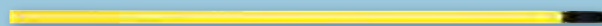

BLADE MATERIAL	SHAFT MATERIAL	LENGTHS (ft.)	WEIGHT
blade sold separately	tempered aluminum	blue: 8, 9, 10 yellow: 8, 8.5, 9, 9.5, 10, 11, 12, 14, 16	113 oz. (9 ft.)

	8	8.5	9	9.5	10	11	12	14	16
Blue	JW0125702030	-	JW0125702050	-	JW0125702070	-	-	-	-
Yellow	JW0125705030	JW0125705040	JW0125705050	JW0125705060	JW0125705070	JW0125705090	JW0125705110	JW0125705140	JW0125705160

HEAVY DUTY

A performance-proven oar shaft. This tempered aluminum push-button take down shaft has a reinforced inner sleeve to maximize strength and stiffness. A contoured handle with a Santoprene grip ensures comfort. Shaft measurements listed include a 26" blade. Blades sold separately.



SHAFT WEIGHT	BLADE WEIGHT	ASSEMBLED WEIGHT	ASSEMBLED LENGTHS (ft.)
77.5 oz.	45.5 oz.	123 oz.	9

	TD 9	TD 10	6.5	8
Blue	JW0125712020	JW0125712040	-	-
Black	-	-	JW0125738650	JW0125738800
Yellow	-	-	JW0125735650	JW0125735800



	Outfitter Blade Button	Oar Locks Metal	Oar Socket Kit (not for thermo canoes)	Oar Socket Kit with oar locks (for thermo)	Oar Locks Clamp On (PR)	Oar Shaft Extender
Black	JW0113320115	-	JW0113312322	01.2604.0690	JW0125100000	-
Silver	-	JW0125053100	-	-	-	-
Blue	-	-	-	-	-	JW0125811120
Yellow	-	-	-	-	-	JW012581.150

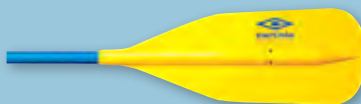

BLADE/SHAFT COLOURS

STANDARD KAYAK PADDLE

An excellent choice for outfitters who demand solid performance and durability. An 8" x 20" symmetrical blade made of high impact polypropylene creates a powerful stroke. Full blade reinforcement adds strength. Push-button takedown allows for easy storage and transportation.

BLADE MATERIAL	SHAFT MATERIAL	LENGTHS (in.)	WEIGHT
high impact polypropylene	aluminum with polyethylene grip	84, 90, 96	48 oz. (84 in.)
8x20	84	90	96
Yellow	JW012560001	-	-
Blue/Blue	-	JW0125222840	JW0125222903
Olive/Olive	-	JW0125300840 (2 Piece)	JW0125300900 (2 Piece)
Yellow/Blue	-	JW0125300960 (2 Piece)	JW0125300960 (2 Piece)
Yellow/Blue	-	JW0113322916 (2 Piece)	JW0113322917 (2 Piece)
Yellow/Blue	-	JW0113322916 (2 Piece)	JW0113322918 (2 Piece)



BLADE COLOURS

SHAFT COLOUR

MAGIC OUTFITTER

Durable, strong and flexible, The Magic Outfitter features an asymmetrical blade design which produces smooth and powerful paddling. A push button take down allows blades to be feathered at 60° or inline for right- and left-handed control.

Two-piece construction provides easy storage. Drip guards included.

BLADE MATERIAL	SHAFT MATERIAL	LENGTHS (cm)	WEIGHT
glass reinforced polypropylene	wrapped fiberglass	220, 230, 240	35 oz. (220 cm)
220	230	240	
White/Black	JW0113322730	JW0113322731	JW0113322732

OUTFITTER

Designed for commercial outfitters, this incredibly durable paddle benefits from an innovative blade design and can really take a beating. T-Grip only.



BLADE MATERIAL	SHAFT MATERIAL	LENGTHS (in.)	WEIGHT
xenoy™	aluminum with polyethylene grip	60, 66	38 oz. (66 in.)
60	66		
Yellow/Blue	JW0113322907	JW0113322909	
Yellow/Red	JW0125605440	JW0125605460	



BLADE COLOURS

SHAFT COLOUR

GUIDE

For professional guides who demand exceptional performance. An 8" x 26" heavy-duty blade delivers great power and a reinforced extra heavy-duty shaft stands up to the toughest conditions. T-Grip only.



BLADE MATERIAL	SHAFT MATERIAL	LENGTHS (in.)	WEIGHT
xenoy™	aluminum with polyethylene grip	66, 72	48 oz. (66 in.)
66	72		
Yellow/Blue	JW0113322911	JW0113322912	



BLADE COLOURS

SHAFT COLOUR

WOODEN PADDLES

Canadian Style Paddle Standard

Pine 1 metre	P16566
Pine 1.25 metre	P16567
Pine 1.50 metre	P16568
Pine 1.40 metre	P10175

Canadian Style Paddle DeLuxe

1.25 metre	P10174
1.40 metre	P16563
1.50 metre	P16564
1.60 metre	P16565



BUOYANCY AIDS & LIFEJACKETS

Fishing Buoyancy Aids

Buoy Aid Plein Sud Fishing 50N	
S30-50kg	P63839
M50-70kg	P63840
L70-90kg	P63841
XL>90kg	P63842

Fishing Lifejackets

Pilot Fishing Lifejacket 150N	
Auto Green	P55835
Hammar Green	P55836

Recreation Buoyancy Aids

Buoy Aid Trophy 50N		
Yellow/Black S30-50kg	P63684	Grey/Black S30-50kg P63929
Yellow/Black M50-70kg	P63685	Grey/Black M50-70kg P63930
Yellow/Black L70-90kg	P63686	Grey/Black L70-90kg P63931
Yellow/Black XL>90kg	P63687	Grey/Black XL>90kg P63932



COMPASSES

Kayak - Offshore 55 Compass

Bkt Orange - Black Card Zone ABC **P63856**

Hand Held - Iris 50 Compass

Yellow - **P63871** Army Green - **P63873**

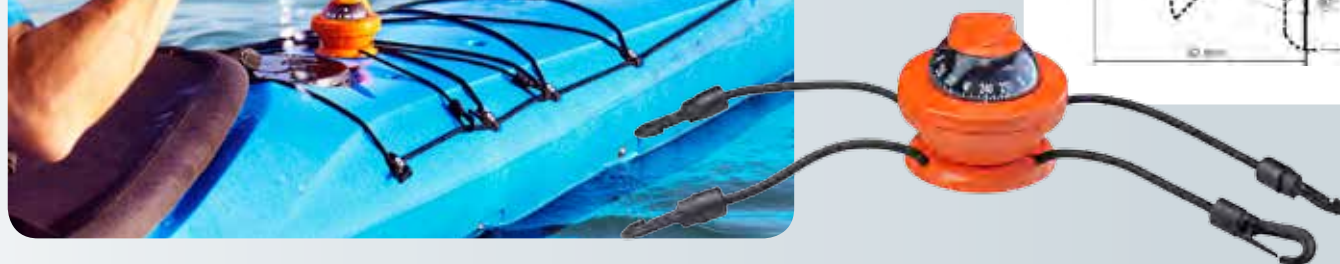
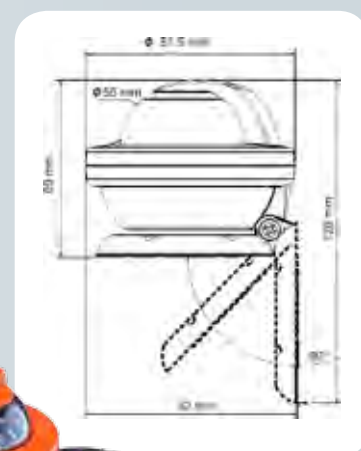

TENDERS & DINGHIES

Rigid Tenders

PRD 300 - 3.0 metre - Green **P30836**

PRD 260 - 2.6 metre - Green **P47418**



Inflatable Tenders

Fish P180SF Inflatable - Green **P61225**

Fish P270SF Inflatable - Green **P61226**

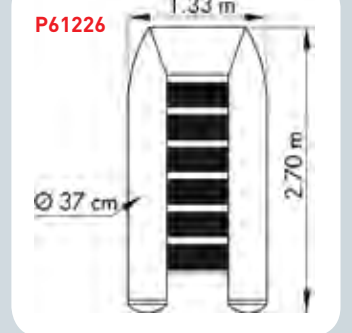
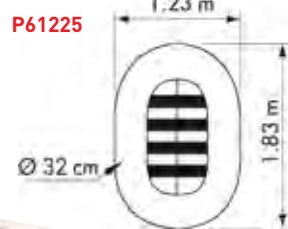

DECK BAGS & DRY TUBES

Waterproof Kayak Deck Bag Capacity: 20Ltr Dimensions: H43 x D14cm ● Colour: Yellow **OB1094Y**



Waterproof Dry Flat Bag Capacity: 5Ltr Dimensions: 23 x 27cm ● Colour: Black **OB1002BLK** ● Colour: Yellow **OB1002Y**
 Capacity: 15Ltr Dimensions: 35 x 37cm ● Colour: Black **OB1004BLK** ● Colour: Red **OB1004R**



Waterproof Dry Tube Bag Capacity: 5Ltr Dimensions: 24 x 19cm ● Colour: Black **OB1001BLK** ● Colour: Blue **OB1001B**
● Colour: Pink **OB1001P** ● Colour: Yellow **OB1001Y**
 Capacity: 12Ltr Dimensions: 40 x 19cm ● Colour: Red **OB1003R** ● Colour: Yellow **OB1003Y**
 Capacity: 20Ltr Dimensions: 40 x 24cm ● Colour: Black **OB1005BLK** ● Colour: Blue **OB1005B**
● Colour: Pink **OB1005P** ● Colour: Yellow **OB1005Y**
 Capacity: 30Ltr Dimensions: 42 x 29cm ● Colour: Red **OB1006R** ● Colour: Yellow **OB1006Y**
 Capacity: 40Ltr Dimensions: 56 x 29cm ● Colour: Blue **OB1007B** ● Colour: Yellow **OB1007Y**
● Colour: Red **OB1007R**



DECK BAGS & DRY TUBES

Pro Vis Dry Tube

Height: 40cm
 Diameter: 24cm
 Circumference: 74cm
 Capacity: 20 litres
 Weight: 0.37g
 Colour: ● Orange **OB1148HVO**
 ● Yellow **OB1148HVY**



Waterproof Window Tube

Capacity: 20Ltr Dimensions: H 43 x D 14cm
 Colour: ● Yellow **OB1057Y**
 Capacity: 30Ltr Dimensions: H 42 x D 29cm
 Colour: ● Black **OB1058BLK**



Ultra-Light Dry Tube

H: 42cm
 Diameter: 29cm
 Circumference: 91.5cm
 Capacity: 30 litres
 Weight: 0.42g
 Colour: ● Red **OB1118R**



Waterproof Backpack Dry Tube

Capacity: 30Ltr Dimensions: 70 x 31cm
 Colour: ● Black **OB1055BLK**



Dry Bag Multipack Divider Set

3 x Combo; 3 Ltr, 6 Ltr & 8 Ltr **OB1032MP**



2 x 20 Ltr Dry Bag Combo **OB1033MP**



DUFFEL BAGS

Adventure Duffel	Capacity: 35Ltr	Dimensions: W28 x H28 x L52cm	● Colour: Red OB1091BLK	● Colour: White OB1091WHT
	Capacity: 60Ltr	Dimensions: W28 x H28 x L52cm	● Colour: Black OB1143BLK	● Colour: White OB1143WHT
	Capacity: 90Ltr	Dimensions: W64 x H31 x L36cm	● Colour: Blue OB1059B	● Colour: Black OB1059BLK
			● Colour: White OB1059WHT	



Pro Sport Duffel	Capacity: 60Ltr	Dimensions: W67 x H27 x L32cm	● Colour: Black OB1154BLK	● Colour: White OB1154R
	Capacity: 90Ltr	Dimensions: W70 x H29 x L39cm	● Colour: Black OB1155BLK	



Classic Duffel	Capacity: 40Ltr	Dimensions: W52 x H23 x L32cm	● Colour: Black OB1150BLK	● Colour: Yellow OB1150Y
	Capacity: 60Ltr	Dimensions: W67 x H27 x L32cm	● Colour: Black OB1151BLK	● Colour: Yellow OB1151Y
	Capacity: 130Ltr	Dimensions: W86 x H33 x L42cm	● Colour: Black OB1152BLK	



DUFFEL BAGS

Classic Duffel	Capacity: 50Ltr	Dimensions: W63 x H27 x L30cm	● Colour: Red	OB1120R		
	Capacity: 60Ltr	Dimensions: W67 x H27 x L32cm	● Colour: White	OB1013WHT		
	Capacity: 60Ltr	Dimensions: W67 x H27 x L32cm	● Colour: Orange	OB1149HVO	● Colour: Yellow	OB1149HVV
			● Colour: White	OB1059WHT		



BACK PACKS

Classic Back Packs	Capacity: 20Ltr	Dimensions: W24 x H43 x L16.5cm	● Colour: Black	OB1141BLK	● Colour: Yellow	OB1141Y
	Capacity: 30Ltr	Dimensions: W34 x H49.5 x L16.5cm	● Colour: Black	OB1142BLK	● Colour: Yellow	OB1142Y



Pro-Vis Back Packs	Capacity: 20Ltr	Dimensions: W24 x H43 x L16.5cm	● Colour: Orange	OB1157HVO	● Colour: Yellow	OB1157HVV
	Capacity: 30Ltr	Dimensions: W34 x H49.5 x L16.5cm	● Colour: Orange	OB1147HVO	● Colour: Yellow	OB1147HVV



BACK PACKS

Pro Sport Back Pack	Capacity: 20Ltr	Dimensions: W24 x H43 x L16.5cm	● Colour: Blue OB1145B	● Colour: Yellow OB1145Y
	Capacity: 30Ltr	Dimensions: W34 x H49.5 x L16.5cm	● Colour: Black OB1146BLK	● Colour: Brown OB1146BRW
			● Colour: Red OB1146R	



Ultra Light Pro Sport Back Pack

Height: 43cm
 Width: 24cm
 Depth: 16.5cm
 Capacity: 20 litres
 Weight: 0.79kg
 Colour: ● Black **OB1135BLK**



Ultra Light Back Pack

Height: 60cm
 Width: 29.5cm
 Depth: 24cm
 Capacity: 50 litres
 Weight: 1.34kg
 Colour: ● Green **OB1119G**
 ● Red **OB1119R**



WATERPROOF PHONE CASES



Small Phone Case

Colour: ● Aqua **OB1008A**

● Black **OB1008BLK**



Flip Phone Case

● Aqua **OB1065A**

● Black **OB1065BLK**



Smart Phone Case

● Black **OB1098BLK**



Large Phone Case

● Black **OB1106BLK**



GPS Case

● Black **OB1009BLK**

Slide Seal System™



WATERPROOF CASES

SLIDE SEAL SYSTEM™



Step 1
Grip switches and slide apart until it clicks into the lock position.



Step 2
Grip switches and slide to centre until they click into the open position.

Camera Case

Compatible with Sony T700, Fujifilm FinePix Z37, Nikon CoolPix S52C and any other similar size device

Colour: Black **OB1025BLK**

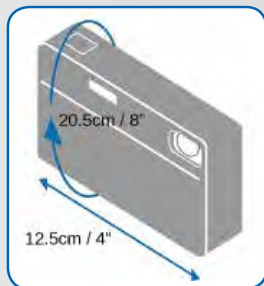

Zoom Lens Camera Case

Compatible with Panasonic Lumix DMC-TZ3, Samsung ST30, Samsung Galaxy S4 Zoom and any other similar size device

Colour: Black **OB1103BLK**

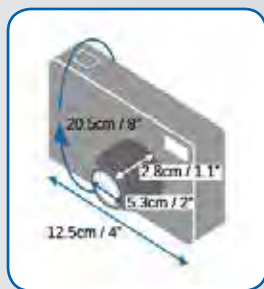

Pro-Sport SLR Roll Top Bag

OB1104BLK



SLR Roll Top Camera Bag Black

Dimensions: 22 x Top 17cm

OB1087BLK



iPod/MP3 Case

Compatible with iPhone (all models including 5S, 5C & 4S), iPod Touch (all models including 3, 4 & 5th generation), iPod Classic (all models) and any other similar size device

Colour: Black **OB1027BLK**

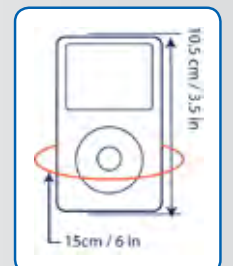
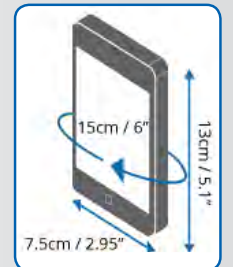

WATERPROOF CASES

VHF Case - Small 33cm

Compatible with Polmar Navy 010, Standard Horizon HX300E and any other similar size device

Colour: ● Black **OB1035BLK**

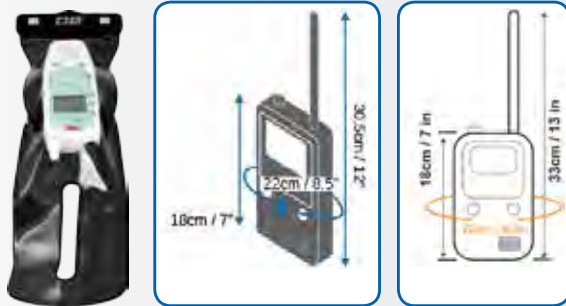

VHF Case - Large 38cm

Compatible with Icom M91D, Standard Horizon HX290E and any other similar size device

Colour: ● Black **OB1036BLK**

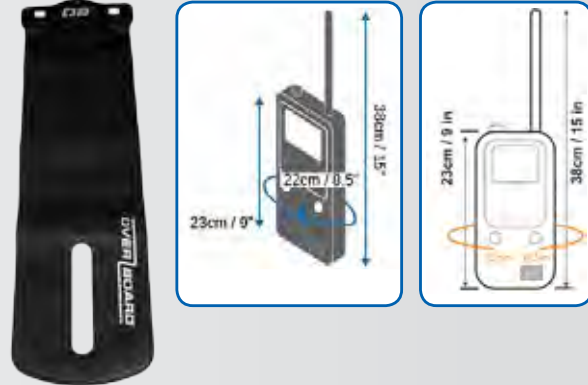

iPad Case Mount

Direct Surface

Colour: ● White **OB1107WHT**

iPad Case & Mount

OB1086PK



iPad Rail Mount

For iPad Case Mount

OB1109



iPad Ram Surface Mount

For iPad Case Mount

OB1110

iPad Mini Boat Mount

Compatible with iPad Mini, Samsung Galaxy Note 8, Kindle Fire 7", Google Nexus 7 and any other similar size device

OB1134WHT

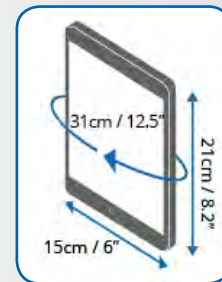

Quick Attachment System



Simple Locking System



Slide Seal System™



Step 1
Grip inner switches between thumb and forefingers and slide apart.



Step 2
Slide outer switches to complete the seal, ensuring all are securely fastened in their locked position.

iPad Mini Case

With Shoulder Strap
Compatible with iPad Mini, Samsung Galaxy Note 8, Kindle Fire 7", Google Nexus 7 and any other similar size device

Colour: Black **OB1083BLK**

iPad Case

With Shoulder Strap
Compatible with iPad (all models including Air), Samsung Galaxy Tab 2 10.1, Kindle Fire HD 8.9 and any other similar size device

Colour: Black **OB1086BLK**



OB1083BLK

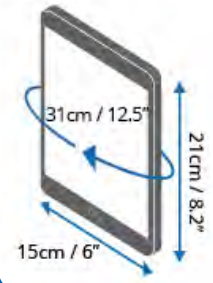

OB1086BLK

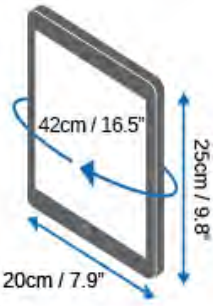

eBook Reader/Kindle Case

OB1082BLK

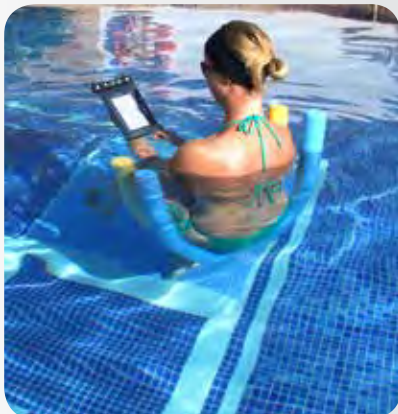

VHF Case - Small 33cm

Dimensions: 36.5 x 27 x 3cm

Colour: Grey **OB1069G**



Multi-Purpose Case

Colour: Frosted

Small Suitable for Keys, Cash, Credit Cards, Lighter **OB1067F**

Medium Suitable for Keys, Cash, Credit Cards, Lighter, MP3 Player, Passport **OB1066F**

Large Suitable for Keys, Wallet, First Aid Kit, Passport, Kindle **OB1088F**

Jumbo Suitable for Sun Cream, Wallet, First Aid Kit, Passport, Kindle **OB1073F**



OB1067F

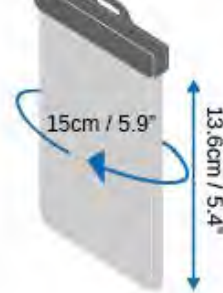

OB1066F

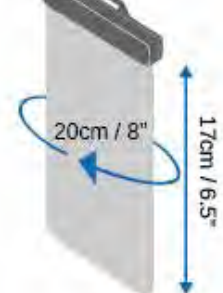

OB1088F

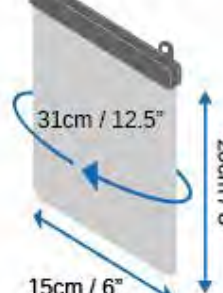

OB1073F



WATERPROOF CASES

C-Safe Waterproof Case

P25590



Dry Pouch

Capacity: 1Ltr

Colour: Blue **OB1031B** Red **OB1031R**
 Black **OB1031BLK** Yellow **OB1031Y**



Waterproof Headphones

Colour: Black **OB1038BLK** White **OB1038WHT**



ProSport Waterproof Headphones

Colour: Black **OB1063BLK**

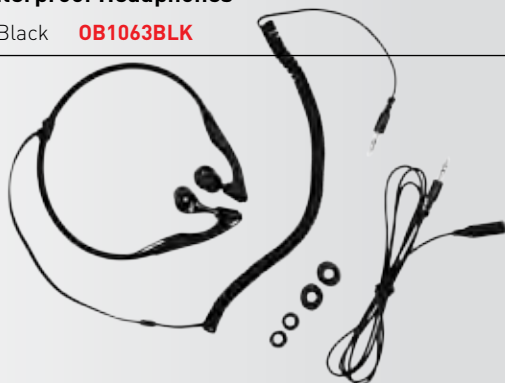

WATERPROOF ACCESSORIES

Waist Pack

Capacity: 1Ltr

Colour: Yellow **OB1049Y**



Arm Pack

Colour: Black **OB1051BLK**

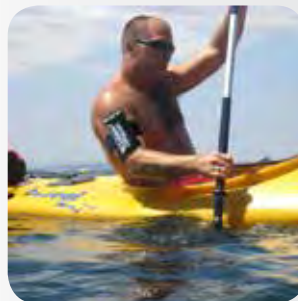

Map Pouch A4

Dimensions: 31.5 x 23.5cm

Colour: Black **OB1081BLK**



Roll Top Messenger Bag

Dimensions: W40.5 x H33 x D9cm

Colour: Black **OB1092BL**



GDC & MULTITOOLS



GDC Hook Knife

Features

- 2-inch hook blade for swift cuts
- Stainless steel construction for durability
- Circular, aluminum handle with thumb grip
- Locks into sheath for added protection
- Keychain ring on sheath

- Backed by Gerber's Lifetime Warranty

Tech Specifications

- Overall Length: 2"
- Weight: .27 oz.
- Steel Type: 7Cr17
- Handle Material: 6061 T6 Aluminum
- Sheath Material: Zytel 101

GE001695

GDC Zip Light+

Features

- Stainless steel construction for durability
- Bright white LED light for visibility
- Two replaceable lithium batteries
- Zipper loop attachment
- Clip for quick removal
- Bottle opener

- Backed by Gerber's Lifetime Warranty

Tech Specifications

- Overall Length: 1.80"
- Steel Type: 420 Stainless
- Handle Material: 3Cr13
- Battery Type: CR 1616
- LED Output: 8 Lumens
- LED Runtime: 3.5 Hours

GE001745



GDC Zip Driver

Features

- 2 flat head drivers (1/8" Bit & 3/16" Bit)
- 2 Phillips head drivers (#1 Bit & #2 Bit)
- Ball detent locking mechanism for added security
- Zipper attachment for easy access

- Quick-release clip for swift removal
- Backed by Gerber's Lifetime Warranty

Tech Specifications

- Overall Length: 2.15"
- Steel Type: 420 Stainless
- Handle Material: 3Cr13

GE001738



Splice Pocket Tool in Black

Features

- Strong mini-scissors
- Keychain compatible
- Lightweight, strong
- Includes Lifetime Limited Warranty

Tech Specifications

- Overall Length: 4.00"
- Closed Length: 2.40"
- Width Open: 3.50"
- Width Closed: 1.00"
- Blade Length: 1.50"
- Weight: 2.50 oz.
- Stainless Steel - Black

Blister Packed - **GE1019241**



GDC Zip Hex

Features

- 2 flat head drivers (1/8" Bit & 3/16" Bit)
- 2 Phillips head drivers (#1 Bit & #2 Bit)
- Ball detent locking mechanism for added security
- Zipper attachment for easy access

- Quick-release clip for swift removal
- Backed by Gerber's Lifetime Warranty

Tech Specifications

- Overall Length: 2.15"
- Steel Type: 420 Stainless
- Handle Material: 3Cr13

GE001740



Vise Pocket Tool in Black

Features

- Strong mini-pliers
- Keychain compatible
- Lightweight, anodized aluminum handles
- Includes Lifetime Limited Warranty

Tech Specifications

- Overall Length: 4.00"
- Closed Length: 2.40"
- Blade Length: 1.50"
- Width Open: 3.50"
- Width Closed: 1.00"
- Weight: 2.00 oz.
- Stainless Steel - Black

Blister Packed - **GE1019242**



GDC Zip Blade

Features

- 2 flat head drivers (1/8" Bit & 3/16" Bit)
- 2 Phillips head drivers (#1 Bit & #2 Bit)
- Ball detent locking mechanism for added security
- Zipper attachment for easy access

- Quick-release clip for swift removal
- Backed by Gerber's Lifetime Warranty

Tech Specifications

- Overall Length: 2.15"
- Steel Type: 420 Stainless
- Handle Material: 3Cr13

GE001742



Shard Keychain Tool

Features

- Lightweight
- Titanium nitride coating for corrosion resistance
- Perfect size with the basics to carry anywhere
- Airline Safe

Tech Specifications

- Overall Length: 2.75"
 - Weight: 0.6 oz
 - Stainless Steel - Titanium Coating
 - Components: 7
- Box Packed - **GE1019240**



Suspension Multi Tool

Features

- Spring-loaded pliers
- Patented Saf.T.Plus
- Open frame design
- Includes Lifetime Limited Warranty
- Components:
 - needlenose pliers
 - wire cutter
 - fine edge knife
 - serrated edge knife
 - saw, scissors
 - crosspoint screwdriver

small and medium flatblade screwdrivers
can opener
bottle opener
lanyard hole

Tech Specifications

- Overall Length: 6"
- Closed Length: 3.5"
- Weight: 9oz.
- Handle Material Stainless Steel
- Sheath Material: Ballistic nylon
- Pliers Type: Needlenose
- Handle Color: Titanium gray

Clam Pack - **GE41471**



Bear Grylls Ultimate Multi

Features

- 12 Stainless Steel, Weather-Resistant Components
 - Needle Nose Pliers
 - Fine Edge Knife
 - Serrated Knife
 - Saw
 - Phillips Screwdriver
 - Small Flat Driver
 - Medium Flat Driver
 - Lanyard Ring
 - Bottle Opener
 - Can Opener
 - Scissors
 - Wire Cutters
- Ergonomic Textured Rubber Grip - Maximizes comfort and reduces slippage
- Spring loaded jaw for simplified single-hand use

- External components for easy access
- Patented Safe.T.Plus System - Enhanced safety by locking components into usage position
- Nylon Sheath - Lightweight, military-grade, mildew resistant
- Includes Land to air rescue instructions
- Priorities of Survival - Pocket guide contains Bear's survival essentials

Tech Specifications

- Open Length: 6.3"
- Closed Length: 4.0"
- Weight: 8.8 oz.

GE31000749



Diesel One Handed Multi Tool

Features

- One-handed opening
- Inboard tools
- Fully locking blades
- Components:
 - needlenose pliers
 - wire cutter
 - partially serrated knife blade
 - cross point screwdriver
 - small, medium and large flat blade screwdrivers

can opener
bottle opener
file
saw
scissors

- Includes Lifetime Limited Warranty

Tech Specifications

- Overall Length: 6.61"
- Closed Length: 4.92"
- Weight: 8.6 oz.

Clam Packed - **GE41470**



Bear Grylls Compact Multi Tool

Features

- 10 Components
 - Needle Nose Pliers
 - Wire Cutters
 - Fine Edge Knife
 - Serrated Knife
 - Phillips Screwdriver
 - Small Flat Driver
 - Medium Flat Driver
 - Lanyard Ring
 - Bottle Opener

Tweezers

- Compact and Lightweight - Fits on keychain or in pocket
- External components and nail nicks for easy access
- Priorities of Survival - Pocket guide contains Bear's survival essentials

Tech Specifications

- Open Length: 4.3"
- Closed Length: 2.5"
- Weight: 3.0 oz

GE31000750



Survival Tool Pack

Features

- Locking Case
- Attaches to Belt / Backpack Strap
- 12 Components
 - Needle Nose Pliers
 - Standard Pliers
 - File
 - Wire Cutters
 - Partially Serrated Blade
 - Wood Saw
 - Small Flathead Driver

- Bottle Open
- Scissors
- Crosshead Driver
- Pierce
- Medium Flathead
- Flashlight
- Firestarter Rod
- Priorities of Survival Guide

Tech Specifications

- Overall Length: 6"
- Closed Length: 4"
- Weight: 11.14 oz.

GE31001047



Evo Multi Tool

Features

- Anodized aluminum handle
- Titanium nitride coated 440 stainless steel blade
- Thumb stud for easy one-hand opening

Components:

- needle nose pliers
- pincher style wire cutter
- saw blade
- cross driver
- fine edge blade
- scissors, small and medium flat drivers
- bottle opener

- can opener
- serrated knife
- lanyard

Tech Specifications

- Overall Length: 6"
- Closed Length: 3.94"
- Weight: 10.25 oz.
- Sheath Material: Ballistic nylon
- Pliers Type: Needle nose

Clam Packed - **GE41771**



MP600 One Handed Opening M/Tool

Features

- Patented one-hand opening Multi-plier
- Solid stainless steel construction
- 14 tools
- Includes Lifetime Limited Warranty

Tech Specifications

- Weight: 9 oz.
- Clam Packed - **GE47530**

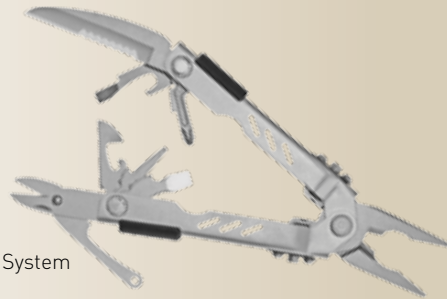

MP400 Compact Sport Multi Tool

Features

- Saf.T.Plus™ Locking System
- Stainless Steel
- One-Handed Opening Pliers
- Needle Nose Pliers
- Partially Serrated Blade
- Phillips Driver
- Small, Medium & Large Flat Drivers
- Bottle Opener & Can Opener
- Fiskars Scissors
- Wire Cutters & Wire Stripper
- Black Ballistic Nylon Sheath
- Made in the USA

Tech Specifications

- Overall Length: 5.6"
- Closed Length: 4.4"
- Weight: 6.8 oz.
- Handle Material: Stainless Steel
- Sheath Material: Fabric
- Pliers Type: Needle Nose
- Handle Color: Bead Blast

Blister Pack - **GE45500**



MP600 ProScout One Handed

Features

- Patented one-hand opening Multi-plier
- Solid stainless steel construction

- 14 tools
- Includes Lifetime Limited Warranty

Tech Specifications

- Weight: 9 oz.
- Multi Opening Tool - **GE47563**

Gator Combo Axe/Knife

Features

- Forged steel head
- Gator grip handle
- Glass-filled nylon handle

Tech Specifications

- Axe:
 - Overall Length: 8.75"
 - Blade Length: 2.70"
 - Weight: 23.60 oz.
 - Head: Forged Steel
 - Handle: Gator-Grip
- Knife:
 - Overall Length: 7.01"
 - Blade Length: 2.88"
 - Weight: 2.00 oz.

Blister Packed - **GE31001054**



Gator Combo Axe II

Features:

- Forged steel head
- Gator grip handle
- Glass-filled nylon handle

Tech Specifications

- Axe:
 - Overall Length: 15.60"
 - Blade Length: 2.70"

- Weight: 26 oz.
- Head: Forged Steel
- Handle: Gator-Grip

- Saw:
 - Overall Length: 10.24"
 - Blade Length: 6.10"
 - Weight: 2.40 oz.

Clam Pack - **GE41420**



Paraframe Mini Folding Knife Fine

Features

- Frame lock handle design
- Lightweight open S/S handles
- Sturdy pocket clip

Tech Specifications

- Overall Length: 6"
- Blade Length: 2.22"
- Closed Length: 3.07"

- Weight: 1.4 oz.
 - Lock Mechanism: Frame-lock
 - Blade Style: Clip Point
 - Blade Material: High Carbon Stainless
 - Blade Type: Fine
 - Handle Material: Stainless Steel
 - One-handed opening
- Clam Packed - **GE48485**



River Shorty Knife - Blunt Tip

An excellent water sports knife, excels in responding to the unique requirements of rafting, paddling and diving. Sturdy stainless steel blade, extremely light glass-filled

nylon handle, and deliberately stunted tip, its sheath designed expressly for mounting onto a PFD

- Open Length: 6.75"
- Total Weight: 4 oz.

GE05640

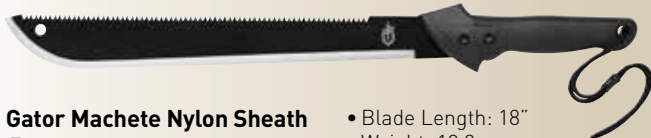

Gator Machete Nylon Sheath

Features

- Tactile rubber grip
- Fine edge and saw blade
- Riveted, nylon sheath included

Tech Specifications

- Overall Length: 25.7"

- Blade Length: 18"
 - Weight: 18 Oz.
 - Head: High Carbon Steel
 - Handle: High Carbon Steel
 - Handle: Gator-Grip
- Blister Packed - **GE31000758**



Bear Grylls Scout Knife

Features

- Thin and Lightweight Folding Knife
- 1/2 Serrated High Carbon Stainless Steel Drop Point Blade - Ideal for edge retention and cutting rope
- Dual-Sided Thumb Stud - For easy single-hand opening
- Ergonomic Textured Rubber Grip - Maximizes comfort and reduces slippage

- Lock Back - Locks blade securely in place and maximizes safety during closing
- Clip for convenient pocket carry
- Priorities of Survival - Pocket guide contains Bear's survival essentials

Tech Specifications

- Overall Length: 7.3"
- Closed Length: 4.0"
- Blade Length: 3.63"
- Weight: 2.4 oz.

Clam Pack - **GE31000754**



Gator Machete Junior

Features

- Tactile rubber grip
- Fine edge and saw blade

Tech Specifications

- Overall Length: 18.75"

- Blade Length: 10.75"
 - Weight: 14.30 oz.
 - Head: High Carbon Steel
 - Handle: Gator-Grip
- Blister Packed - **GE31000759**



Bear Grylls Survival Series - Ultimate Knife

Features

- Fine Edge Drop Point
- High Carbon Stainless Steel Blade
- Texturized Rubber Handle
- Hard Rubber Military Grade Sheath
- Diamond Knife Sharpener

- Emergency Whistle
 - Priorities of Survival Guide
- #### Tech Specifications
- Blade Length: 4.8"
 - Overall Length: 10"
 - Weight: 11.2 oz.
 - Weight in Sheath: 14 oz.
 - Steel Type: 7Cr17Mov
- Clam Pack - **GE31000751**

Bear Grylls Grandfather Knife

Features

- The knife's 7 components include a fine edge blade, flat driver, Phillips driver, corkscrew, bottle opener, file and lanyard ring
- The stainless steel Bear Grylls badge plays on the knife's vintage origins and lends it a classic look
- The rubber-over-mold grip gives the knife a comfortable feel and adds security to your grip
- Includes a copy of Bear Grylls "Priorities of Survival" Pocket Guide for easy reference
- Backed by Gerber's Lifetime Warranty



Tech Specifications

- Overall Length: 6.50", 16.5cm
- Blade Length: 2.75", 6.9 cm
- Closed Length: 3.75", 9.5 cm
- Weight: 3.5 oz, 99.2 g
- Steel Type: 5Cr15Mov
- Handle Material: Over-molded TPU Rubber w/stainless steel BG Badge

GE31001685



STL 2.5 Folding Knife

Features

- Fully Machined Stainless Steel Handle - Thin handle with style and comfort
- Frame Lock
- Full Fine Edge Drop Point Blade

Tech Specifications

- Blade Length: 2.6 in.
 - Open Length: 6.0 in.
 - Closed Length: 3.4 in.
 - Weight: 1.5 oz.
- Clam Pack - **GE31000716**



Bear Grylls Sharpener

Features

- Hard Plastic Cover
- Pocket Size

- Grippy Handle
 - Sharpens Fine Edge & Serrated Blades
 - Priorities of Survival Guide
- #### Tech Specifications
- Overall Length: 4.5"
 - Total Weight: 2.3 oz.
 - Steel Type: SS416 Grit 400
 - Coarse Carbide Insert
 - Fine Ceramic Insert

Blister Packed - **GE31001270**



Bear Grylls Pocket Tool

Features

- Tough, Rubberized Handle
- All Basic Tools
- 5 Components
- Fine Edge Blade
- Bottle Opener
- Philips head driver

- Small & Medium Size Flat Driver
 - Priorities of Survival Guide
- Tech Specifications*
- Overall Length: 5.5"
 - Closed Length: 3.2"
 - Weight: 2.9 oz.
 - Steel Type: 5CR15 Stainless

Box Packed - **GE31001050**



Paraframe I Folding Knife Serrated

Features

- Frame lock handle design
 - Lightweight open stainless steel handles
 - Sturdy pocket clip
- Tech Specifications*
- Overall Length: 7.01"
 - Blade Length: 3.01"
 - Closed Length: 4.11"

- Weight: 2.6 oz.
 - Lock Mechanism: Frame-lock
 - Blade Style: Clip Point
 - Blade Material: High Carbon Stainless
 - Blade Type: Serrated
 - Handle Material: Stainless Steel
 - Opening Style: One-handed opening
- Clam Packed - **GE48443**



E-Z Out Rescue Knife 89mm

Features

- Textured handle with SoftGrip
 - One-hand opening
 - Full serration with blunt tip
- Tech Specifications*
- Overall Length: 7.91"
 - Blade Length: 3.51"
 - Closed Length: 4.51"
 - Weight: 2.6 oz.

- Lock back
- Blade Style: Clip Point
- Blade Material: High Carbon Stainless
- Blade Type: Full Serration
- Handle Material: Glass-filled nylon with Softgrip Inserts
- Opening Style: One-handed opening

Box Packed - **GE06971**



Paraframe I Folding Knife Fine

Features

- Frame lock handle design
 - Lightweight open stainless steel handles
 - Sturdy pocket clip
- Tech Specifications*
- Overall Length: 7.01"
 - Blade Length: 3.01"
 - Closed Length: 4.11"

- Weight: 2.6 oz.
 - Lock Mechanism: Frame-lock
 - Blade Style: Clip Point
 - Blade Material: High Carbon Stainless
 - Blade Type: Fine
 - Handle Material: Stainless Steel
 - Opening Style: One-handed opening
- Clam Packed - **GE48444**



Applegate Combat Folder Knife

Features

- Heavy-duty construction
 - Patented secondary locking system
 - One-handed opening
- Tech Specifications*
- Overall length: 10.1"
 - Blade length: 4.5"
 - Closed length: 5.6"

- Weight: 7.4 oz.
- Lock mechanism: liner lock, patented locking system
- Blade style: spear
- Blade type: double bevel
- Handle material: glass-filled nylon

Blister Packed - **GE45780**



Paraframe Mini Folding Knife Serrated

Features

- Frame lock handle design
 - Lightweight open stainless steel handles
 - Sturdy pocket clip
- Tech Specifications*
- Blade Length: 2.22"
 - Closed Length: 3.07"
 - Weight: 1.4 oz.

- Lock Mechanism: Frame-lock
 - Blade Style: Clip Point
 - Blade Material: High Carbon Stainless
 - Blade Type: Serrated
 - Handle Material: Stainless Steel
 - Opening Style: One-handed opening
- Clam Packed - **GE48484**



Ultralight LST Fine Edge 50mm

Features

- Lightweight synthetic handle
 - Tactile textured handle
 - Lock-back design
- Tech Specifications*
- Overall Length: 4.62"
 - Blade Length: 1.96"
 - Closed Length: 2.65"

- Weight: 0.6 oz.
- Lock Mechanism: Lock-back
- Blade Style: Drop Point
- Blade Material: 420HC Stainless Steel
- Blade Type: Fine
- Handle Material: Glass-filled nylon

Clam Pack - **GE46050**



Gator Exchange-a-Blade Saw - 2 Blade

Features

- Exchange coarse or fine saw blade with ease
 - High carbon stainless steel blade and handle
 - Gator grip overmold on handle
- Tech Specifications*
- Overall Length: 15.55"

- Closed Length: 8.78"
 - Blade Length: 6.65"
 - Weight: 10.80 oz.
 - Blade Type: Coarse/Wood and Fine/Bone
 - Handle: Gator-Grip
- Clam Packed - **GE41457**

SURVIVAL KITS



Bear Grylls Scout Essentials Kit

Features

- Polypropylene case
- First Aid Kit
- Waterproof Matches
- L.E.D. Micro Torch Light
- Compact Scout Knife
- Button Compass
- Priorities of Survival Guide

Tech Specifications

- Overall Size: 4.75" x 3.75" x 1"
- Weight: 5.4 oz.

Blister Packed - **GE31001078**



Bear Grylls Survival Kit Ultimate

Features

- 16 Piece Kit
- Miniature Multi-tool
- Needle Nose Pliers
- Wire Cutters
- Fine Edge Knife
- Phillips Screwdriver
- Small Flat Driver
- Medium Flat Driver
- Lanyard Ring
- Bottle Opener
- Tweezers
- Waterproof Bag
- Miniature Light
- Hand Saw
- Signaling Mirror
- Survival Blanket
- Fire Starter
- Waterproof matches

- Cotton Ball - Fire Tinder
- Snare Wire
- Emergency Cord
- Waxed Thread
- Fishing Kit
- Sewing kit
- Lanyard Whistle
- Lightweight, ripstop nylon bag with waterproof zipper
- Land to air rescue instructions
- Priorities of Survival - Pocket guide contains Bear's survival essentials

Tech Specifications

- Sheath Dimensions: 4.5" x 5.0"
- Overall Weight: 4.2 oz.

Clam Pack - **GE31000701**



Bear Grylls Survival Basic Kit

Features

- 8 Piece Kit
- Waterproof Bag
- Mini-Paraframe™ Knife

- Emergency Whistle
- Fire Starter
- Waterproof Matches
- Snare Wire
- Emergency Cord
- Cotton Ball - Fire Tinder
- Lightweight, ripstop nylon bag with waterproof zipper
- Land to air rescue instructions
- Priorities of Survival - Pocket guide contains Bear's survival essentials

Tech Specifications

- Sheath Dimensions: 4.5" x 5.0"
- Overall Weight: 4.2 oz.

Clam Packed - **GE31000700**

Bear Grylls 1Litre Canteen Water Bottle

Features

- Food Grade Aluminum Cup
- BPA-Free Water Bottle
- Nylon Sheath with Belt Loop
- Leak-Proof Lock Top
- Priorities of Survival Guide

Blister Packed - **GE31001062**



TORCHES



Bear Grylls Headlamp Torch

Features

- Hands Free
- Headband Stows Extra Battery
- Adjustable Lamp
- Priorities of Survival Guide

Tech Specifications

- Overall Length: 2.45"
- Overall Width: 1.31"

- Weight: 3.89"
- Battery: AAA
- Lumens
 - Low: 8
 - High: 30
- Run Time
 - Low: 15 hrs
 - High: 8.75 hrs

GE31001028



Bear Grylls Micro Light

Features

- Compact
- Long Lasting L.E.D. Bulb
- 4 Settings – High, Low, Beacon/ Blinking & Off
- Easy to Use Soft Rubber Switch
- Priorities of Survival Guide

Tech Specifications

- Overall Length: 1.78"

- Weight: .28 oz.
- Batteries: [2] CR1616
- Lumens
 - Low: 3, High: 8
 - Beacon/Blinking: 8
- Runtime
 - Low: 9 hrs, High: 3.5 hrs
 - Beacon/Blinking: 6 hrs

GE31001034



Torch Rechargeable Xenon

Features

- 4 to 6 times brighter than standard equipment.
- Unbreakable: unconditionally warranted*.
- All lights feature an o-ring seal and are watertight or waterproof (minimum IP54), depending on models.
- Waterproof, corrosion-proof

and chemical resistant (highly-resistant polymer body and stainless steel metallic parts).

Tech Specifications

- Lightsource Type: Xenon.
- Length: 165mm
- Battery Run Time: 3.5 Hours
- Weight: 220g
- Batteries 4 x AA

P57928



Torch LED

Peli™ has developed top-performance and ultra-resistant torches, designed to withstand the specific harsh conditions of the marine environment. *Provided that the instructions of use have been followed. This warranty does not cover accessories such as bulbs, batteries, or the battery contents.

Features

- 4 to 6 times brighter than standard equipment.
- Unbreakable: unconditionally warranted*.
- All lights feature an o-ring seal and are watertight or waterproof (minimum IP54), depending on models.
- Waterproof, corrosion-proof and chemical resistant (highly-resistant polymer body and stainless steel metallic parts).

Tech Specifications

- Lightsource Type: L.E.D.
- Length: 67mm
- Battery Run Time: 4 Hours
- Weight: 30g
- Batteries 4 x LR

P57925



Torch Nemo Submersible Nemo

Features

- 4 to 6 times brighter than standard equipment.
- Unbreakable: unconditionally warranted*.
- All lights feature an o-ring seal and are watertight or waterproof (minimum IP54), depending on models.

Waterproof, corrosion-proof and chemical resistant (highly-resistant polymer body and stainless steel metallic parts).

Tech Specifications

- Lightsource Type: Xenon.
- Length: 198mm
- Battery Run Time: 4.5 Hours
- Weight: 360g
- Batteries 3 x C

P57926



Recon Task Light

Features

- Blue, Red, Green and White lens options
- Clip allows for hands-free use
- Lightsource Type: L.E.D.

- Lightsource Quantity: 1
- Output Color: White, Red, Green and Blue
- Housing Material: Type III anodized 6061 aluminum body
- Weight: 2.6 oz.

Blister Packed - **GE80016**

HOOK - FISHFINDERS

- The Hook family is the new entry-level standalone series
- Designed to specifically target the entry-level fisherman in the market for high-value electronics
- CHIRP Sonar technology
 - No other standalone competitor has integrated CHIRP Sonar with three frequency ranges
 - No other competitor has DownScan Overlay
- Simple to use
 - Intuitive page selection
 - Simple menu selections
 - On-screen sonar adjustments
- Mapping options
 - Insight Genesis
 - Insight PRO
 - Navionics
 - C-MAP
- Quick-release, tilt-swivel bracket with optional custom RAM integration
- Improved connectors for upgrade compatibility- power and transducer
- Trackback™ sonar
- Quick Release/Tilt/Swivel Gimbal Bracket
- Power cable HDS/Elite-HDI power cable



Hook-3X

With 83/200 EMEA - Language Pack - **NC12717001**
 With 83/200 - **NC12635001**
 With 455/800 - **NC12636001**
 All-Season Pack with 83/200 & EU Plug Adaptor - **NC12639001**



Hook-4

Mid/High/DownScan - **NC12647001**
Hook-4X
 Mid/High - **NC12640001**
 Mid/High/DownScan™ - **NC12641001**



Hook-5

No Transducer - **NC12655001**
 Mid/High/DownScan™ - **NC12656001**
Hook-5X
 Mid/High/DownScan™ - **NC12653001**



Hook-7

Base No xdcr - **NC12663001**
 Base with Mid/High/DownScan™ - **NC12664001**
Hook-7X
 Mid/High/DownScan™ - **NC12660001**

ELITE - FISHFINDERS

- Touchscreen Display
- Built-in Wireless and Bluetooth
GoFree Shop
Chart purchase/download
Insight Genesis data upload/download
- StructureScan Sonar
Integrated StructureScan and CHIRP
Sonar with simultaneous operation
- NMEA2000 Networking
- CHIRP Sonar Technology
Built-in CHIRP sonar
- High CHIRP for shallow water and high resolution detail
- Medium CHIRP for wide coverage area and better depth penetration
- Better at marking fish targets and lure tracking
Trackback™ View
- Rewind sonar to review after scanning an area- like having a two feet wide display!
- No pausing of live sonar while using Trackback View
- Bottom Color Tracking Mode
- Separates structure and fish from the bottom with distinct bottom coloring
- Mapping
- More chart options: Insight, Navionics, C-map, and more!
- Create your own personal mapping with Insight Genesis
- Engine/data sensors - Engine Interfacing



Elite-5 Ti

Dimensions:

- Display 5" - 800 x 480
 - W 176.10mm x H 113.31mm x D 61.50mm
 - Overall size with bracket W 176.10mm x H 134.85mm x D 113.46mm
 - Quick release mounting bracket
- With No Transducer - **NC12420001**
 With Mid/High/DownScan™ - **NC12421001**
 With Mid/High/TotalScan™ - **NC12423001**



Elite-7 Ti

Dimensions:

- Display 7" - 800 x 480
 - W 219.48mm x H 141.25mm x D 63.68mm
 - Overall size with bracket W 219.48mm x H 160.83mm x D 116.83mm
 - Quick release mounting bracket
 - NMEA2000
- No Transducer - **NC12416001**
 Mid/High/DownScan™ - **NC12417001**
 Mid/High/TotalScan™ - **NC12419001**

HDS - FISHFINDERS



HDS-7 GEN3 ROW

Features

- Multi-touch 7" Widescreen
 - Full Control via touchscreen or keypad
 - Integrated wireless connectivity
 - Dual micro SD card slots
 - 10Hz internal GPS antenna
 - Single Ethernet networking port
 - Optional video input via adapter cable
 - Same flush mount cutout and bracket as HDS-7 GEN2 Touch
- NOXD** - **NC11787001**
83/200/LSS - **NC11799001**

SUNCOVERS & INSIGHT GENESIS



Suncover 5" Mark/Elite/ Hook
NC10050001



HDS -7 Suncover
NC12242001



Hook-3 Suncover
NC10495001



Hook-7 Suncover
NC11069001

INSIGHT GENESIS PLANNER

Insight Genesis allows you to create customized maps from your own survey data for free. It is as easy as uploading a sonar log from your Lowrance chartplotter to the Insight Genesis web site. Within minutes you will receive a link to view your customized contour map. The subscription upgrade allows you to download maps for use on your compatible plotter, overlay vegetation and bottom composition views, and access community data via the new Social Mapping Layer.

NC11199001



SIMRAD - G05

Get more from every day on the water with the **Simrad G05 XSE**, a perfect fit for compact sportboats and dayboats. Behind its super-bright touchscreen lies a chartplotter with built-in GPS receiver, and Wi-Fi access to the latest charts and updates. Control your onboard sound system, monitor engine data and more over NMEA 2000®, and choose from an array of built-in sonar technologies: cruise with confidence using ForwardScan™ forward-looking sonar, or find fish like a pro with Broadband Sounder™ CHIRP sonar plus StructureScan® HD SideScan and DownScan Imaging™.

Specifications:

Display Type:	WVGA Colour TFT LCD
Display Size:	5-inch Widescreen
Display Resolution:	800 x 480 pixels
Backlighting Levels:	LED / 1200 nits
GPS Antenna Type:	10 Hz built-in GPS
Operating Temperature:	-15°C to +55°C (5°F to 131°F)
Waterproof Standard/rating:	IPX7
Width:	152 mm / 5.98 in
Depth:	57.9 mm / 2.28 in
Height:	120 mm / 4.72 in
Weight:	0.54 kg / 1.18 lb
Power Consumption:	900 mA @ 13.5 V
Power Supply (Supply Voltage):	12 V DC

Key Features

- Easy to use multi-touch interface
- Full-featured chartplotter with widest available cartography support (Insight, Navionics, CMAP)
- Plan smarter with TriplIntel™ technology
- 5-inch flush or bracket mount display
- Widescreen with bright LED backlight
- High-speed 10 Hz GPS receiver
- Broadband echosounder with CHIRP
- Built-in ForwardScan™ sonar (transducer required)
- Built-in StructureScan® imaging (transducer required)
- Built-in GoFree™ Wi-Fi
- NMEA 2000® compatible

G05 NO XDCR - NC12455001

G05 MED/HI/DWNSCN - NC12674001

G05 XSE, TOTALSCAN - NC12673001

G05 NO XDCR - NC12451001

G05 MED/HI/DWNSCN - NC12452001

G05 XSE, TOTALSCAN - NC12675001

PLASTIC DECK SEALS



Micro Deck Seal
Cables up to Dia 6mm
SSDS6P



Plastic Mini Deck Seal
for Connectors up to 16mm
SSDS16P



Plastic Small Deck Seal
for Connectors up to 21mm
SSDS21AP



Plastic Small Deck Seal
for Connectors up to 21mm
SSDS21BP



Plastic Medium Deck Seal
for Connectors up to 30mm
SSDS30P



Plastic Large Deck Seal
for Connectors up to 40mm
SSDS40P



Horizontal Entry Deck Seal
Cables up to Dia 6mm
SSDSH6

STAINLESS STEEL & ALUMINIUM DECK SEALS



Stainless Steel Mini Deck Seal
for Connectors up to 16mm
SSDS16S



Stainless Steel Small Deck Seal
for Connectors up to 21mm
SSDS21AS



Stainless Steel Small Deck Seal
for Connectors up to 21mm
SSDS21BS



Stainless Steel Medium Deck Seal
for Connectors up to 30mm
SSDS30S



Stainless Steel Large Deck Seal
for Connectors up to 40mm
SSDS40S



Aluminium Multi Deck Seal
For Connectors up to 15mm
SSDSMULTI



STARPORT

White - **SSRL08400622**

Black - **SSRL08400612**

White - **SSRL08401422**

Black - **SSRL08401412**



ADJUSTABLE DECK MOUNT

Body & Base

SSRLADM



ADJUSTABLE MOUNT

with Railblaza Tail

SSRLARB



ADJUSTABLE RAIL MOUNT

Body & Rail Clamp

SSRLARM

TOP PLATES



Hummingbird 300-700

SSRL501



Garmin GPS MAP 400-600

SSRL502



Lowrance HDS-5/HDS-7

SSRL504



Garmin GPS MAP 700 Series

SSRL507



Lowrance Elite 5 / Mark 5

SSRL503



Lifedge Mounting Bracket

SSRL505



Raymarine A6 & A7

SSRL506



Ultimate Xtreme Clean 379ml
 • All surface Cleaner/
 Degreaser
SB083200EUR



Ultimate Paddlesports Cleaner
 • With protectant and PTEF
 • 650ml
SB096022GF



Instant Hull Cleaner
 • Gel Spray
 • 1L
SB096132GF



Odour Guard Surface Cleaner
 • Deodorizer/Freshner
 • 650ml
SB095322GF



Ultimate Vinyl Guard PTEF
 • 950ml
SB095932GF



Ultimate Fibreglass Stain Remover
 • 1L
SB098932GF



Clear Plastic Restorer
 • 236ml
SB87208



Plastic Polish Restorer
 • 236ml
SB87308



Epoxy Putty Stick
 • 113grm
SB87104



**SeaSafe Teak Cleaner/
 Brightener**
 • 3.79L
SB089790EUR



**Ultimate Aluminium
 Polish PTEF**
 • 500ml
SB087616GF



**Ultimate Aluminium
 Boat Cleaner**
 • Acid Formula
 • 1.89L
SB087764GF



Rust Stain Remover
 • 3.79L
SB089200EUR

MULTI-POWER GENERATOR

Use to charge Tablets, SLR Cameras, Phones, GPS Two-Way Radios ... and more

- Rugged and Water Resistant
- 5V & 12V Charger

Infinite Orbit Unit

Black - **TEXCRM003**

Infinite Orbit Unit

Red - **TEXCRM009**



POWER MONKEY EXTREME BLACK

The powermonkey extreme can be recharged in three ways; via the universal mains charger, via the solar panel or via USB. Whilst the unit is recharging, the LCD screen will be red, once fully charged, the screen will turn green. When the unit is in use, the screen will be blue!

The powermonkey extreme is capable of charging iPads and tablets too. iPad 1, iPad 2, iPad 3 and iPad mini can be plugged directly into the extreme's USB socket via customer's Apple-supplied white sync/charge cable and will recharge up to 2 times depending on the model of your iPad. The iPad 4 has slightly different charging requirements and so the 2013 powermonkey extreme includes a gorilla-pad adaptor specifically for this model. The gorilla-pad plugs into the 12V DC socket and is used together with customer's Apple sync/charge cable to charge iPad 4. You can also use the gorilla-pad for the other iPads/tablets or to give yourself another 5V USB socket if required

You may also want to consider the aquastrap - a clever accessory designed specifically for the powermonkey extreme to keep it watertight whilst it charges your devices!

- Waterproof for 30mins up to 1metre , Shock Resistant - ideal for Marine Environment
- When used with additional Aquastrap it will be kept watertight whilst charging devices
- 9000mAh Lithium Polymer Battery - holds 70% of its charge for up to 12months
- Power Bank can be charged from mains and holds enough charge to recharge an iPhone 4 times
- Comes with Solar Array for charging remotely - MPPT allows efficient charging in low light conditions
- Powerbank can be charged by solar at the same time as recharging devices
- Powerbank has separate 5v USB and 12v DC port which can be used at the same time

- Friction switch on/off can be operated with gloved hand, auto shut off feature
- LCD screen shows power status of the powerbank
- Supplied with a range of connectors and leads - up to 1 metre and shock resistant - perfect for the outdoor, marine and adventure enthusiast, as well as military and aid agencies. When used in conjunction with the aquastrap, the powermonkey extreme will be kept watertight whilst it charges your devices.

POWPMEXT003



BATTERIES - PLATINUM AGM JET SKI - 12V POWER



- 13AH - 12Volts
- Dimensions: 135 x 89 x 160mm

PBCTM14BS

- 13AH - 12Volts
- Dimensions: 135 x 89 x 160mm

PBCTM14LBS



- 16AH - 12Volts
- Dimensions: 205 x 70 x 162mm

PBCTM16ALBS

- 20AH - 12Volts
- Dimensions: 205 x 87 x 162mm

PBCTM18LBS

- 19AH - 12Volts
- Dimensions: 175 x 100 x 155mm

PBCTM19BS

- 21AH - 12Volts
- Dimensions: 151 x 87 x 161mm

PBCTMX16CLBS

- 18AH - 12Volts
- Dimensions: 175 x 87 x 155mm

PBCTMX20LBS



Weighted End Folding Grapnel

Galvanised 0.7kg

Q023244



Grapnel Spoon Flukes

Nominal Weight 1.5Kg

P16471



Grapnel Straight Flukes

Nominal Weight 1.5Kg

P16449



Grapnel Straight Flukes

Nominal weight 0.7Kg

P17682



Claw Anchor

Ideal for mud, sand and rocky bottoms

Q023228 -Weight 1kg
Galvanised

Q023229 - Weight 2kg
Galvanised







Unit 8 Flanders Park, Hedge End, Southampton, Hants SO30 2FZ

T: 01489 776030 F: 01489 776035

www.bainbridgetechnical.com