



BAINBRIDGE
INTERNATIONAL

www.bainbridgeint.com

**HARDWARE & MARINE COVERS
CATALOGUE**

Introduction

Welcome to Bainbridge International's new Hardware & Marine Covers Catalogue - Your guide to the world's leading range of sail and cover maker's hardware, tools, fabrics and accessories.

Founded in 1917, Bainbridge International is one of the longest established sailcloth manufacturers in the world, with almost a century's experience in developing and supplying the highest quality, highest performance materials and hardware to the marine industry.

Our objective is to be the single point of contact for all your sailmaking needs. In addition to our high quality proprietary products, we also distribute products from many top international marine brands, which you'll find listed within this catalogue.

We supply a diverse range of products to many industries through our sales locations in Southampton, UK and in Massachusetts and California in the USA. Our trained and experienced sales staff, supported by our network of global distributors, service customers in over 80 countries and are backed by well stocked warehouse facilities able to efficiently meet the needs of our customers.

New Products

Our dedication to product development, coupled with our commitment to providing quality and innovation is what has made Bainbridge a market leading organisation for almost 100 years. This latest catalogue includes more new products than ever before, a selection of which are highlighted below:

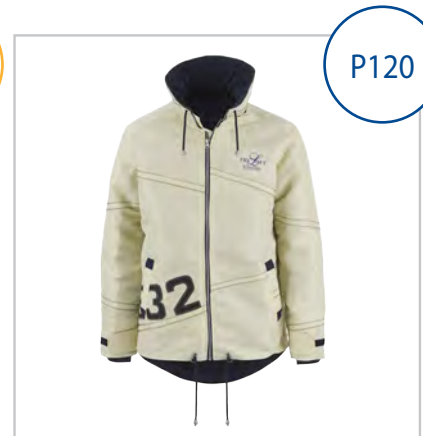
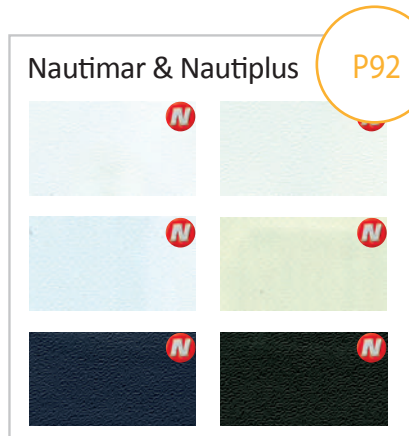

Table of Contents



Hardware - Pages 3 to 68

Battens & Batten Fixings, Slides, Hanks, Shackles & Cleats, Rings & Grommets, Headboards, Sail Tapes & Ropes, Insignia & Adhesive Materials, Webbing, Zip & Velcro, Thread & Seaming Tapes.



Tools - Pages 69 to 84

Hot Knives, Scissors, Awls, Clamps, Splicing Kits, Hammers, Punches, Pattern Materials, Cleaners & Polish, Palms & Needles, Protectants & Repair Kits.



Marine Covers - Pages 85 to 108

Solacryl Acrylic Cover Fabrics, Polyester Cover Fabrics, Track & Tapes, Fasteners, Boat Top Fittings & Accessories.



Windows, Mesh & Fabrics - Pages 109 to 118

Window Material, Mesh, Trampoline & Bag Fabrics.



The Loft - Pages 119 to 122

Sailcloth Jackets, Barrel Bags, Deluxe Holdalls, Sailcloth Wasbags, Tote Bag

Marketing Support

Order Online at www.bainbridgeint.com

By logging on to www.bainbridgeint.com you can browse our online catalogue and trade e-commerce site, view live stock availability and up to the minute pricing. The products shown on our website also appear in our catalogues, however as we introduce new products, these appear first on the website.

By using your unique and secure login details, you can place orders directly, reserve stock for quick delivery and benefit from emailed order confirmation.

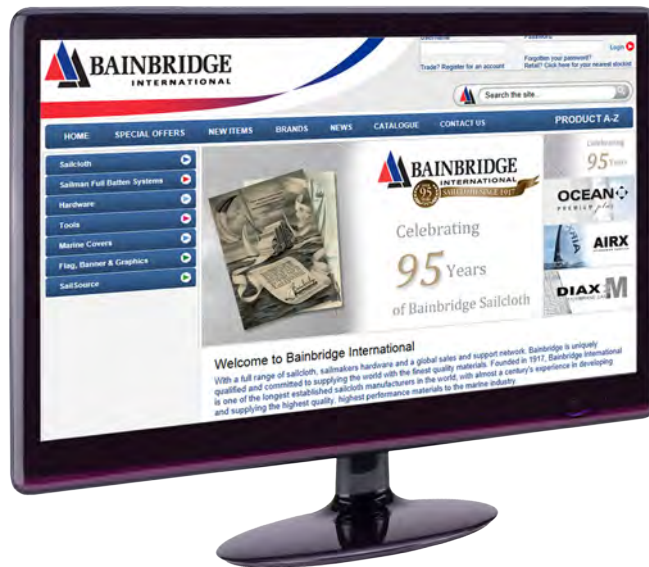

Marketing Support

Bainbridge has always recognised that as a trade supplier, our success is dependent on the success of our customers. With this in mind, we have continued to update and evolve the marketing support that we offer. This includes an informative range of leaflets for the end user and a comprehensive sailcloth sample system for you and your customers. Our website, www.bainbridgeint.com, is dedicated to supporting both the sailmaker and the boat owner.





Battens

Aquabatten Pro	4-5
Dinghy Aquabattens	6-7
Jib Aquabattens	8
Yacht Aquabattens	8-9
Untapered Battens	10-11

Batten Fixings

Pocket Protectors	12
Batten Tensioners & End Fittings	13
SDA Full Batten Fittings	14-15

Sail Hardware

Track Slides	16-18
Shackles	19-20
Jib Hanks	21
Outhaul Blocks & Clewboards	22
Dinghy Headboards	23
Yacht Headboards	24-26
Headboard, Liners, Rivets	27
Leechline Cleats	28-31

Tapes & Ropes

Luff Tape	32-33
Sailcloth Tape	34-35
Ropes	36
Shockcord Fittings	37-39

Rings & Grommets

Inox Pressed Ring System	40-41
Grommets	42-43
Stainless Steel Rings	42-45
Rings & Snap Hooks	46

Webbing Materials

Webbing Attachments	47-49
Coloured Polypropylene Webbing	50
Polyester Webbing	51
Speciality Webbing	52

Insignia

Class Insignia	55
Sail Letters & Numbers	56-57

Seaming Tapes

Seaming Tape	58
Seam Bonding Tape	59-61

Zip & Velcro

Zip	62-63
Velcro®	64

Thread

Heminway & Bartlett Thread	65
"Anti-Wick" Thread & Bobbins	66
Hand Sewing Thread	67-68

Aquabatten-Pro

Aquabatten-Pro are based on a combination of modern resin and laminate technology, and over 50 years of experience in batten manufacture and design. The extensive development programme behind these battens involved first identifying the optimum stiffness and taper for modern racing sails and then optimizing our time tested production system to use higher performance laminates. Compared to regular Aquabattens these designs provide increased stiffness by increasing thickness and save weight by reducing width.



With a range of widths and stiffnesses, durable and efficient laminated construction and carefully designed tapers, Aquabatten-Pro is the best range of production performance battens available today.

Benefits

- Lighter.
- Increased Stiffness.
- New materials utilize latest pre-preg technology.
- Tough and Durable.
- Step down laminate construction (not ground pultrusion) so load bearing fibres run full length.
- Super smooth finish.
- Optimized taper to suit modern racing sail designs.
- Lengths up to 2200mm.
- Ideal for mainsail and genoa leech applications.
- Technically superior manufacturing system allows precise resin/glass ratio control.
- Made in Britain.
- 50 years plus of research and development.

15mm Aquabatten-Pro

15mm Aquabatten-Pro battens are available in 3 stiffness ratings allowing the sailmaker to select different bend characteristics at each batten position on boats up to about 30ft.

Part No.	Stiffness	Width: mm/in		Thickness: mm/in		Length: mm/in	
15PR0600S3	S3 (Stiff)	15	5/8	8	5/16	600	23 5/8
15PR0800S3	S3 (Stiff)	15	5/8	8	5/16	800	31 1/2
15PR1000S3	S3 (Stiff)	15	5/8	8	5/16	1000	39 3/8
15PR1200S3	S3 (Stiff)	15	5/8	8	5/16	1200	47 1/4
15PR1400S3	S3 (Stiff)	15	5/8	8	5/16	1400	55 1/8
15PR1600S3	S3 (Stiff)	15	5/8	8	5/16	1600	63
15PR1800S3	S3 (Stiff)	15	5/8	8	5/16	1800	70 1/8
15PR2000S3	S3 (Stiff)	15	5/8	8	5/16	2000	78 3/4
15PR2200S3	S3 (Stiff)	15	5/8	8	5/16	2200	86 5/8
15PR0600S5	S5 (Extra Stiff)	15	5/8	9	11/32	600	23 5/8
15PR0800S5	S5 (Extra Stiff)	15	5/8	9	11/32	800	31 1/2
15PR1000S5	S5 (Extra Stiff)	15	5/8	9	11/32	1000	39 3/8
15PR1200S5	S5 (Extra Stiff)	15	5/8	9	11/32	1200	47 1/4
15PR1400S5	S5 (Extra Stiff)	15	5/8	9	11/32	1400	55 1/8
15PR1600S5	S5 (Extra Stiff)	15	5/8	9	11/32	1600	63
15PR1800S5	S5 (Extra Stiff)	15	5/8	9	11/32	1800	70 1/8
15PR2000S5	S5 (Extra Stiff)	15	5/8	9	11/32	2000	78 3/4
15PR2200S5	S5 (Extra Stiff)	15	5/8	9	11/32	2200	86 5/8
15PR1200S7	S7 (Super Stiff)	15	5/8	10	13/32	1200	47 1/4
15PR1400S7	S7 (Super Stiff)	15	5/8	10	13/32	1400	55 1/8
15PR1600S7	S7 (Super Stiff)	15	5/8	10	13/32	1600	63
15PR1800S7	S7 (Super Stiff)	15	5/8	10	13/32	1800	70 1/8
15PR2000S7	S7 (Super Stiff)	15	5/8	10	13/32	2000	78 3/4
15PR2200S7	S7 (Super Stiff)	15	5/8	10	13/32	2200	86 5/8

20mm Aquabatten-Pro

The 20mm versions are also available in 3 stiffness ratings and are ideal for boats up to about 40ft.

Part No.	Stiffness	Width: mm/in		Thickness: mm/in		Length: mm/in	
20PR0600S3	S3 (Stiff)	20	3/4	8	5/16	600	23 5/8
20PR0800S3	S3 (Stiff)	20	3/4	8	5/16	800	31 1/2
20PR1000S3	S3 (Stiff)	20	3/4	8	5/16	1000	39 3/8
20PR1200S3	S3 (Stiff)	20	3/4	8	5/16	1200	47 1/4
20PR1400S3	S3 (Stiff)	20	3/4	8	5/16	1400	55 1/8
20PR1600S3	S3 (Stiff)	20	3/4	8	5/16	1600	63
20PR1800S3	S3 (Stiff)	20	3/4	8	5/16	1800	70 1/8
20PR2000S3	S3 (Stiff)	20	3/4	8	5/16	2000	78 3/4
20PR2200S3	S3 (Stiff)	20	3/4	8	5/16	2200	86 5/8
20PR0600S5	S5 (Extra Stiff)	20	3/4	9	11/32	600	23 5/8
20PR0800S5	S5 (Extra Stiff)	20	3/4	9	11/32	800	31 1/2
20PR1000S5	S5 (Extra Stiff)	20	3/4	9	11/32	1000	39 3/8
20PR1200S5	S5 (Extra Stiff)	20	3/4	9	11/32	1200	47 1/4
20PR1400S5	S5 (Extra Stiff)	20	3/4	9	11/32	1400	55 1/8
20PR1600S5	S5 (Extra Stiff)	20	3/4	9	11/32	1600	63
20PR1800S5	S5 (Extra Stiff)	20	3/4	9	11/32	1800	70 1/8
20PR2000S5	S5 (Extra Stiff)	20	3/4	9	11/32	2000	78 3/4
20PR2200S5	S5 (Extra Stiff)	20	3/4	9	11/32	2200	86 5/8
20PR1200S7	S7 (Super Stiff)	20	3/4	10	13/32	1200	47 1/4
20PR1400S7	S7 (Super Stiff)	20	3/4	10	13/32	1400	55 1/8
20PR1600S7	S7 (Super Stiff)	20	3/4	10	13/32	1600	63
20PR1800S7	S7 (Super Stiff)	20	3/4	10	13/32	1800	70 1/8
20PR2000S7	S7 (Super Stiff)	20	3/4	10	13/32	2000	78 3/4
20PR2200S7	S7 (Super Stiff)	20	3/4	10	13/32	2200	86 5/8

25 & 30mm Aquabatten-Pro

A full range of Aquabatten-Pro battens are also available in 25 and 30mm widths to special order.



End Cap for Aquabatten-Pro



15EC002

Part No.	Position	Max Width: mm/in		To Fit Batten	Pack Qty
15EC002	Inner	19	3/4	15PR	10

Other lengths and widths are available to special order. All special order items are subject to minimum order quantities and lead times. Prices on application.

Other lengths and widths are available to special order. All special order items are subject to minimum order quantities and additional lead times. Prices on application.



Applications for Aquabatten-Pro

Boat Size	Rig Type	Top	Upper Middle	Lower Middle	Bottom
25 - 30 Foot	Fractional	15PR - S3	15PR - S3	15PR - S3	15PR - S5
	Masthead	15PR - S3	15PR - S3	15PR - S3	15PR - S3
30 - 35 Foot	Fractional	15PR - S3	15PR - S3	15PR - S5	15PR - S5
	Masthead	15PR - S3	15PR - S3	15PR - S5	15PR - S5
35 - 40 Foot	Fractional	20PR - S3	20PR - S5	20PR - S7	20PR - S7
	Masthead	20PR - S3	20PR - S5	20PR - S7	20PR - S7
40 - 45 Foot	Fractional	20PR - S5	20PR - S5	20PR - S7	25PR - S5
	Masthead	20PR - S3	20PR - S5	20PR - S7	25PR - S5
45 - 50 Foot	Fractional	20PR - S5	20PR - S7	25PR - S5	25PR - S7
	Masthead	20PR - S3	20PR - S5	20PR - S7	25PR - S5
50 - 55 Foot	Fractional	25PR - S3	20PR - S5	25PR - S7	25PR - S7
	Masthead	25PR - S3	20PR - S5	25PR - S5	25PR - S5

10mm Dinghy Aquabattens®

10mm Leech Aquabattens

Taper-laminated glassfibre Aquabattens have become the recognized standard for the world's racing dinghy sailmakers.

- 10D Aquabattens are specifically designed as a lightweight, durable leech batten for dinghy sails, and are suitable up to a boat size of approximately 18 feet.
- 10DS Aquabattens have a softer tip to give better blend into the sail shape and to reduce the risk of "batten poke".
- Made in Britain.
- 50 years plus of research and development.
- Prices do NOT include endcaps.

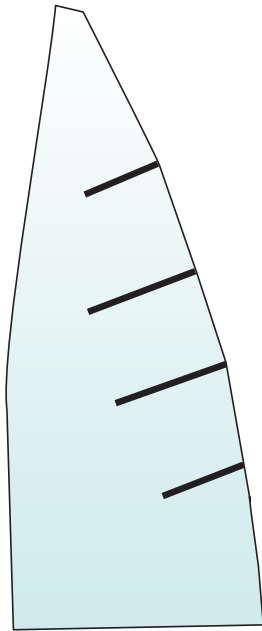

Part No. Standard	Part No. Soft	Description	Length (When Endcaps Fitted): mm/in	
10D0300		Leech	300	11 3/4
10D0400	10DS0400	Leech	400	15 3/4
10D0500	10DS0500	Leech	500	19 3/4
10D0600	10DS0600	Leech	600	23 5/8
10D0700	10DS0700	Leech	700	27 1/2
10D0800	10DS0800	Leech	800	31 1/2
10D0900	10DS0900	Leech	900	35 3/8
10D1000	10DS1000	Leech	1000	39 5/8
10D1100	10DS1100	Leech	1100	43 1/4
10D1200	10DS1200	Leech	1200	47 1/4
10D1400		Leech	1400	55 1/8

Batten Sets

For 10 identical sets or more, dinghy battens can be supplied cut to exact length. Battens can also be supplied with endcaps fitted and can be made up into sets. Additional lead times apply.

Prices on application.



10mm Top Aquabattens

Taper-laminated glassfibre Aquabattens have become the recognized standard for the world's racing dinghy sailmakers.

- Standard Top battens are designed as full length battens for sails with a limited roach.
- Stiff battens provide more support for sails designed with a larger roach.
- Made in Britain.
- 50 years plus of research and development.
- Prices do NOT include endcaps.

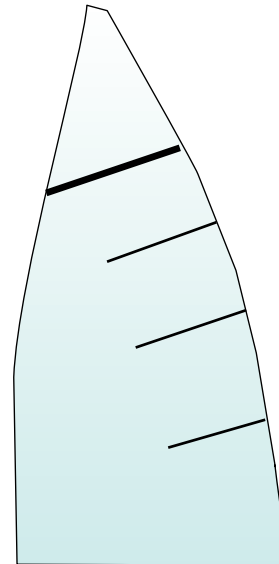

Part No.	Description	Length*: mm/in (*when Endcaps Fitted)	
10D1000T45	Standard 45%	1000	39 3/8
10D1200T45	Standard 45%	1200	47 1/4
10D1400T45	Standard 45%	1400	55 1/8
10D1100T50	Standard 50%	1100	43 1/4
10D1200T50	Standard 50%	1200	47 1/4
10D1400T50	Standard 50%	1400	55 1/8

Other lengths and widths are available to special order. All special order items are subject to minimum order quantities and additional lead times. Prices on application.



Endcaps for 10mm Aquabattens

- Maximum width of endcap is 18mm.
- Please note that endcaps must be ordered separately.



10DECI



10DECO



10DXSTECI

Part No.	Position	To Fit Batten	Pack Qty
10DECI	Inner	10D, 10DS, 10D Top	10
10DECO	Outer	10D, 10DS, 10D Top, 10D Stiff	10
10DXSTECI	Inner	10D Stiff	10

15mm Dinghy Aquabattens®

15mm Leech Aquabattens

Taper-laminated glassfibre Aquabattens have become the recognized standard for the world's racing dinghy sailmakers.

- 15D Aquabattens are designed as leech battens for large dingies, keelboats and smaller yachts up to 24ft.
- 15DS Aquabattens have a softer tip to give better blend into sailcloth shape and to reduce the risk of "batten poke".
- Where these battens are used as replacements in older design sails, which have 40mm/1½" sail pockets, 15DWEC endcaps may be preferred (see below).
- Prices do NOT include endcaps.

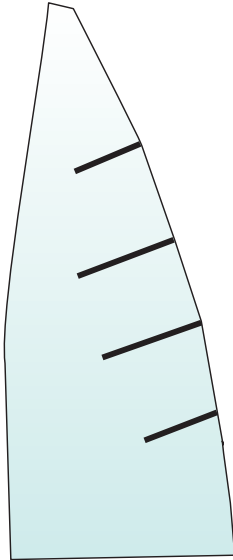

Part No. Standard	Part No. Soft	Description	Length (When Endcaps Fitted): mm/in	
15D0300		Leech	300	11 3/4
15D0400	15DS0400	Leech	400	15 3/4
15D0500	15DS0500	Leech	500	19 3/4
15D0600	15DS0600	Leech	600	23 5/8
15D0700	15DS0700	Leech	700	27 1/2
15D0800	15DS0800	Leech	800	31 1/2
15D0900	15DS0900	Leech	900	35 3/8
15D1000	15DS1000	Leech	1000	39 5/8
15D1100	15DS1100	Leech	1100	43 1/4
15D1200	15DS1200	Leech	1200	47 1/4
15D1400		Leech	1400	55 1/8

Endcaps for 15mm Aquabattens

- Maximum width of endcap is 18mm.
- Please note that endcaps must be ordered separately.



Part No.	Position	To Fit Batten	Pack Qty
15DNECI	Inner	15D, 15DS, 15D Top	10
15DNECO	Outer	15D, 15DS, 15D Top, 15D Top Stiff	10
15DXSTECI	Inner	15D Top Stiff	10
15DWEC	Pair	15D, 15DS, 15D 15D Top	10

15mm Top Aquabattens

Taper-laminated glassfibre Aquabattens have become the recognized standard for the world's racing dinghy sailmakers.

- Standard Top battens provide more support and are designed as full length battens for sails with a limited roach.
- Stiff battens provide more support for sails designed with a larger roach.
- Prices do NOT include endcaps.

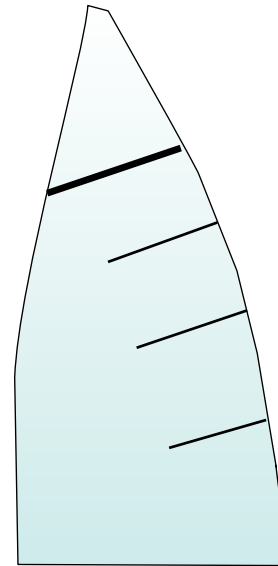

Part No.	Description	Length (When Endcaps Fitted): mm/in	
15D1000T45	Standard 45°	1000	39 3/8
15D1100T45	Standard 45°	1100	43 1/4
15D1200T45	Standard 45°	1200	47 1/4
15D1400T45	Standard 45°	1400	55 1/8
15D1000T50	Standard 50°	1000	39 3/8
15D1200T50	Standard 50°	1200	47 1/4
15D1400T50	Standard 50°	1400	55 1/8
15D1000X45	Stiff 45°	1000	39 3/8
15D1100X45	Stiff 45°	1100	43 1/4
15D1200X45	Stiff 45°	1.00	47 1/4
15D1400X45	Stiff 45°	1.00	55 1/8
15D1000X50	Stiff 50°	1000	39 1/8
15D1200X50	Stiff 50°	1200	47 1/4
15D1400X50	Stiff 50°	1400	55 1/8

Batten Sets

For 10 identical sets or more, dinghy battens can be supplied cut to exact length. Battens can also be supplied with endcaps fitted and can be made up into sets. Additional lead times apply.

Prices on application.



Other lengths and widths are available to special order. All special order items are subject to minimum order quantities and additional lead times.

Prices on application.



Jib & Yacht Aquabattens®

10mm & 15mm Jib Battens

The toughness and durability of this Aquabatten laminated strip makes it ideal for reduction of leech-flutter in jibs and can, with confidence, be sewn permanently into the sail.

- Cut ends should be rounded with a file to avoid the risk of chafing of the sail or stitching. Some sailmakers may wish to use plastic endcaps.
- Prices do NOT include endcaps.



Part No.	Style	Length: mm/in	
10CSOJ	Soft	2000	78 3/4
10CSTJ	Stiff	2000	78 3/4
N 10CXSTJ	Extra Stiff	2000	78 3/4
15CSOJ	Soft	2000	78 3/4
15CSTJ	Stiff	2000	78 3/4
N 15CXSTJ	Extra Stiff	2000	78 3/4
30CSTJ	Stiff	2000	78 3/4

Yacht Aquabattens

The toughness and durability of Bainbridge International's taper-laminated glassfibre sail battens has been proven over the 50 years plus since they were first introduced. Their design ensures that the shape that is so carefully built into the sail is maintained and, as a result, they are the discerning sailmaker's first choice.

15mm Yacht Aquabattens

- These tapered battens are designed for small cruisers and daysailors up to 24ft.
- Use 15DNECI (inner) and 15DNECO (outer) endcaps. (see below)
- Prices do NOT include endcaps.



Part No.	Style	Length: mm/in	
15C0800	Yacht	800	31 1/2
15C0900	Yacht	900	35 3/8
15C1000	Yacht	1000	39 3/8
15C1100	Yacht	1100	43 1/4
15C1200	Yacht	1200	47 1/4
15C1400	Yacht	1400	55 1/8

Other lengths and widths are available to special order. All special order items are subject to minimum order quantities and additional lead times. Prices on application.



Endcaps for 15mm Battens

- Please note that endcaps must be ordered separately.
- 15DWEC are for use with 40mm/1 1/2" batten pockets.



Part No.	Position	To Fit Batten	Pack Qty
15DNECI	Inner	15D, 15DS, 15D Top	10
15DNECO	Outer	15D, 15DS, 15D Top, 15D Top Stiff	10
15DWEC	Pair	15D, 15DS, 15D 15D Top	10

Yacht Aquabattens®

30mm Soft Nose Aquabattens

- Soft Nose Battens are designed for racing sails, where the design incorporates long battens which extend well into the curved area of the sail. They are extra soft at the forward tip to improve the blend into the sail shape and to reduce the risk of "batten poke".
- Prices do NOT include endcaps.



Part No.	Style	Length: mm/in	
30CSN0600	30mm Soft Nose	600	23 5/8
30CSN0700	30mm Soft Nose	700	27 1/2
30CSN0800	30mm Soft Nose	800	31 1/2
30CSN0900	30mm Soft Nose	900	35 3/8
30CSN1000	30mm Soft Nose	1000	39 3/8
30CSN1200	30mm Soft Nose	1200	47 1/4
30CSN1400	30mm Soft Nose	1400	55 1/8
30CSN1600	30mm Soft Nose	1600	63

30mm and 40mm Special Aquabattens

- Special battens offer a compromise, and enable many of the advantages of the various types to be achieved without the need to carry additional battens. They are also to be preferred in more modern designs, where long battens are permitted and the battens extend further into the body of the sail. The forward tip is comparable in stiffness to the soft type, while the leech end has a stiffness comparable to the extra stiff type.
- Prices do NOT include endcaps.



Part No. 30mm	Part No. 40mm	Description	Length: mm/in	
30CSP0400		Special Cruiser	400	15 3/4
30CSP0500	40CSP0500	Special Cruiser	500	19 3/4
30CSP0600	40CSP0600	Special Cruiser	600	23 5/8
30CSP0700	40CSP0700	Special Cruiser	700	27 1/2
30CSP0800	40CSP0800	Special Cruiser	800	31 1/2
30CSP0900	40CSP0900	Special Cruiser	900	35 3/8
30CSP1000	40CSP1000	Special Cruiser	1000	39 5/8
30CSP1100	40CSP1100	Special Cruiser	1100	43 1/4
30CSP1200	40CSP1200	Special Cruiser	1200	47 1/4
30CSP1400	40CSP1400	Special Cruiser	1400	55 1/8
30CSP1600	40CSP1600	Special Cruiser	1600	63
30CSP1800	40CSP1800	Special Cruiser	1800	70 1/8
30CSP2000	40CSP2000	Special Cruiser	2000	78 3/4
30CSP2200	40CSP2200	Special Cruiser	2200	86 5/8

50mm and 60mm Yacht Aquabattens

- A full range of yacht aquabattens are also available in 50mm and 60mm widths to special order.

Other lengths and widths are available to special order. All special order items are subject to minimum order quantities and additional lead times. Prices on application.



30mm and 40mm Stiff Aquabattens

- Stiff battens are designed for use in intermediate positions in the sail, where it requires more roach support, or alternatively for use in the top position in heavier weather conditions.
- Prices do NOT include endcaps.



Part No. 30mm	Part No. 40mm	Description	Length: mm/in	
30CST0700		Stiff	700	27 1/2
30CST0800		Stiff	800	31 1/2
30CST0900		Stiff	900	35 3/8
30CST1000	40CST1000	Stiff	1000	39 5/8
30CST1200	40CST1200	Stiff	1200	47 1/4
30CST1400	40CST1400	Stiff	1400	55 1/8
30CST1600	40CST1600	Stiff	1600	63
30CST1800	40CST1800	Stiff	1800	70 1/8
30CST2000	40CST2000	Stiff	2000	78 3/4

30mm and 40mm Extra Stiff Aquabattens

- Stiff battens are designed for use in intermediate and lower positions in the sail, where requirement is to keep the leech very flat.
- Prices do NOT include endcaps.



Part No. 30mm	Part No. 40mm	Description	Length: mm/in	
30CXST0700		Extra Stiff	700	27 1/2
30CXST0800		Extra Stiff	800	31 1/2
30CXST0900		Extra Stiff	900	35 3/8
30CXST1000	40CXST1000	Extra Stiff	1000	39 5/8
30CXST1200	40CXST1200	Extra Stiff	1200	47 1/4
30CXST1400	40CXST1400	Extra Stiff	1400	55 1/8
30CXST1600	40CXST1600	Extra Stiff	1600	63
30CXST1800	40CXST1800	Extra Stiff	1800	70 1/8
30CXST2000	40CXST2000	Extra Stiff	2000	78 3/4

Endcaps

- Please note that endcaps must be ordered separately.



Part No.	Description	Pack Qty
30CEC	30mm Endcap	10
40CEC	40mm Endcap	10
50CEC	50mm Endcap	10

Untapered Battens

Flat Battens - Polyester

These low cost, quality pultrusions are tough, durable and minimise sail chafe. 30CT styles are 30mm wide but vary in thickness to offer logical and progressive increases in stiffness. This allows different stiffness' to use the same width pocket and luff box.

- Manufactured from pultruded glassfibre.
- 30CT styles offer logical increases in stiffness and compliment the Sailman battens range.
- 16HCP is used by most of the new skiff type dinghy classes.
- Only available in full lengths except 30CT031R and 30CT044R which are sold as 30m reels.

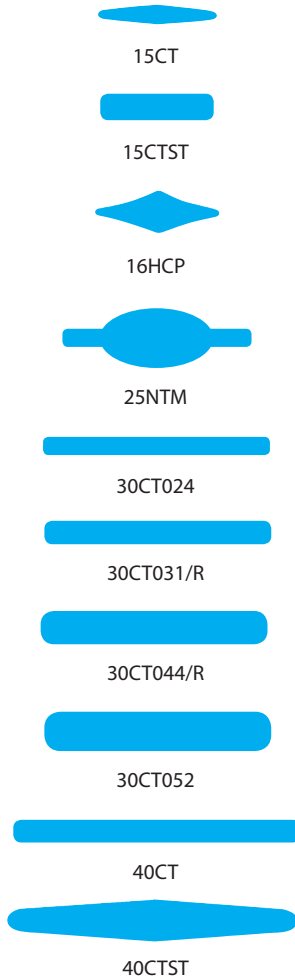

Part No.	Width: mm/in	Thickness: mm/in	Stiffness	Weight: gm/m/oz ft	Length: m/ft
15CT*	15mm 5/8"	2.5mm 3/32"	100	60gsm 0.7oz ft	6m 19.7ft
15CTST	15mm 5/8"	3.5mm 3/32"	550	84gsm 0.9oz ft	6m 19.7ft
16HCP*	16mm 5/8"	6mm 1/4"	1800	108gsm 1.2oz ft	6m 19.7ft
25NTM	25mm 1"	7.9mm 5/16"	5000	186gsm 2.0oz ft	7.62m 25ft
30CT024	30mm 1 1/4"	2.4mm 3/32"	500	145gsm 1.6oz ft	6m 19.7ft
 30CT031/R*	30mm 1 1/4"	3.1mm 1/8"	1000	188gsm 2.0oz ft	30m 98ft
 30CT044/R*	30mm 1 1/4"	4.4mm 5/16"	3000	266gsm 2.9oz ft	30m 98ft
30CT052	30mm 1 1/4"	5.2mm 7/32"	5000	315gsm 3.4oz ft	6m 19.7ft
40CT	38mm 1 3/4"	3mm 1/8"	1000	192gm/m 2.1oz/ft	6m 19.7ft
40CTST*	38mm 1 3/4"	5mm 5/16"	4500	292gsm 3.1oz ft	6m 19.7ft

*15CT, 16HCP and 40CTST are diamond profiles. 30CT031R and 30CT044R are sold as 30m reels.

Flat Battens - Vinylester

A high quality range of 20mm Vinylester pultrusions. The narrow but thick profiles provide a high stiffness/weight ratio. The thickness of each profile has been calculated precisely to provide a logical sequence of stiffness!

- High quality Vinylester construction.
- Progressive range of stiffness!
- Ideal for full length battens on race sails.
- Only available in full lengths.

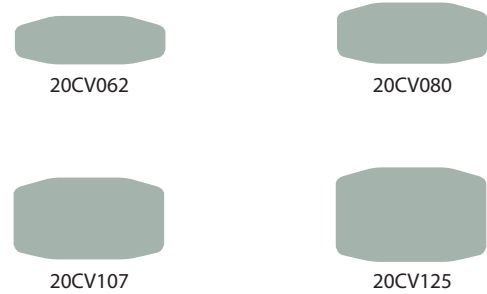

Part No.	Width: mm/in	Thickness: mm/in	Stiffness	Weight: gm/m/oz ft	Length: m/ft
20CV062	20mm 3/4"	6.2mm 1/4"	4500	212gsm 7.4oz ft	12m 39.4ft
20CV080	20mm 3/4"	8.0mm 5/16"	10000	273gsm 9.6oz ft	12m 39.4ft
20CV107	20mm 3/4"	10.7mm 7/16"	38000	376gsm 13.3oz ft	12m 39.4ft
20CV125	20mm 3/4"	12.8mm 1/2"	62000	441gsm 15.5oz ft	12m 39.4ft

Batten Sets

All battens on this page can be supplied cut to exact length. Battens can also be supplied with endcaps fitted and can be made up into sets. Additional lead times apply. Prices on application.



Stiffness

Stiffness is calculated as load needed to deflect by 100mm a 1 metre length, supported at both ends. The load is measured in grammes.

Deflection at 5kgs: Stiffer sections cannot be tested by the above method, and these are tested by measuring the deflection in millimetres under a fixed load of 5kgs.

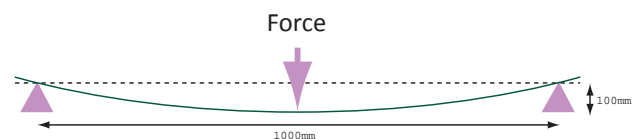

Untapered Battens

Sailman™ Battens

Highest quality vinylester pultrusions deliver ultimate strength and durability for demanding full batten applications. Featuring a logical and progressive range of stiffness, and a common 30mm width.

- Purpose designed range for Bainbridge Internationals range of full batten systems - See Sailman Update for more details.
- Highest quality vinylester pultruded glassfibre.
- Ultimate tenacity for full batten sails in an offshore application.
- Offer round batten stiffness without the problems of chafe and 'batten snake'.

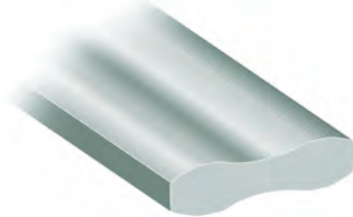

Part No.	Width: mm/in	Thickness: mm/in	Stiffness	Weight: gm/m/oz ft	Length: m/ft
U30063	30mm 1.18"	6.3mm 0.25"	7kgm	293gsm 3.2oz ft	12m 39.4ft
U30076	30mm 1.18"	7.6mm 0.31"	15kgm	382gsm 4.1oz ft	12m 39.4ft
U30102	30mm 1.18"	10.2mm 0.40"	37kgm	530gsm 5.7oz ft	12m 39.4ft
U30114	30mm 1.18"	11.4mm 0.44"	58kgm	618gsm 6.6oz ft	12m 39.4ft
U30127	30mm 1.18"	12.7mm 0.5"	94kgm	704gsm 7.6oz ft	12m 39.4ft

Endcaps for Flat Battens

- Use these endcaps for untapered batten styles.



15CTECI



15CTECO



15DXSTECI



25CTJM



30CEC



30CTEC



40CEC



A150

Part No.	Use With Battens	Overall Width: mm/in	Pack Qty
15CTECI	15CT	20 3/4	10
15CTECO	15CT	20 3/4	10
15DXSTECI	15CTST/16HCP	20 3/4	10
25CTJM	25NTM	28 1 1/2	10
30CEC	30CT024/30CT031	35 1 3/8	10
30CTEC	30CT044/30CT052	35 1 3/8	10
40CEC	40CT/40CTST	42 1 5/8	10
A150	16HCP	28 1 1/2	10

Round Battens

Outstanding stiffness to weight combined with low cost make round section pultrusions an excellent choice for full batten applications although they are more liable to breakage and can cause sail chafe.

- Considerably better stiffness/weight ratio than flat battens.
- Longer lengths are available against special order. Long packages may however involve the purchaser in higher than normal freight costs.
- Only available in full lengths.



Round Battens - Specifications

Part No.	Thickness	Stiffness	Deflection	Weight	Length
06R	6mm 1/4"	1kgm	-	52gms/m 0.7oz/ft	6m 19.7ft
06R30	6mm 1/4"	1kgm	-	52gms/m 0.7oz/ft	30m 98ft
08R	8mm 5/16"	3.5kgms	-	88gms/m 1.0oz/ft	6m 19.7ft
08R30	8mm 5/16"	3.5kgms	-	88gms/m 1.0oz/ft	30m 98ft
10R	10mm 7/16"	9kgms	58	114gms/m 1.4oz/ft	6m 19.7ft
12R	12mm 13/32"	17kgms	29	211gms/m 2.1oz/ft	6m 19.7ft
14R	14mm 9/16"	26kgms	19	286gms/m 3.07oz/ft	6m 19.7ft
16R	16mm 5/8"	60kgms	9	364gms/m 3.92oz/ft	6m 19.7ft
20R	20mm 25/32"	-	5	560gms/m 6.03oz/ft	6m 19.7ft

Endcaps for Round Battens

- Manufactured from nylon.
- Spreads load at end of sail pocket.



Part No.	Use With Batten	Width: mm/in	Pack Qty
06REC	06R	20.0 13/16	10
08REC	08R	20.0 13/16	10
10REC	10R	32.5 1 5/16	10
12REC	12R	32.5 1 5/16	10
14REC	14R	50.0 2	10
16REC	16R	50.0 2	10
20REC	20R	50.0 2	10

Batten Sets

All battens on this page can be supplied cut to exact length. Battens can also be supplied with endcaps fitted and can be made up into sets. Additional lead times apply. Prices on application.



Pocket Protectors & Pocket Elastic

Batten Pocket Protectors for Dinghy Sails

- Semi-circular seat permits wide range of batten angles.
- Smoothly radiused nose gives low friction contact with the mast.
- Price includes screws.



Part No.	Max Batten Width: mm/in		Max Cavity Depth: mm/in		Pack Qty
A001	15	5/8	14	9/16	10

Batten Pocket Protectors for Dinghy and Catamaran Sails

- Semi-circular seat permits wide range of batten angles.
- Smoothly radiused nose gives low friction contact with the mast.
- Price includes screws for A002 and rivets for A004.
- A004 rivets use C324 closing tool.
- Only available in full packs.



A002

A004

Part No.	Max Batten Width: mm/in		Max Cavity Depth: mm/in		Pack Qty
A002	30	1 5/16	25	1	10
A004	30	1 5/16	25	1	10

Batten Pocket Protectors for Catamaran and Full Batten Dinghy Sails

- Internal shape permits wide range of batten angles.
- High strength design with high load screws to resist end thrust of stiff battens.
- Smoothly radiused nose gives low friction contact with the mast.
- Price includes screws.
- Only available in full packs.

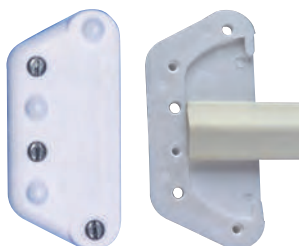

Part No.	Max Batten Width: mm/in		Max Cavity Depth: mm/in		Pack Qty
A302	30	1 5/16	20	3/4	10

Batten Pocket Protectors for Larger Catamaran Sails

- Method of attachment gives excellent resistance to side loads.
- Smoothly radiused nose gives low friction contact with the mast.
- Price includes screws and nuts.
- Available in full packs only.

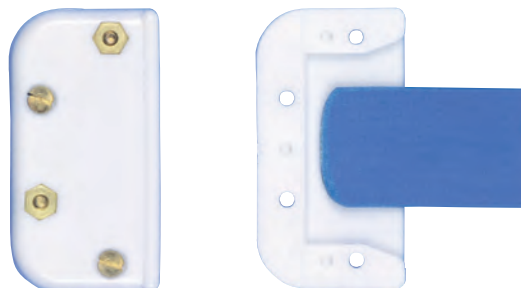

Part No.	Max Batten Width: mm/in		Max Cavity Depth: mm/in		Pack Qty
A006	40	1 5/8	24	1	10

Batten Pocket Protectors for Large Cruising Sails

- Suitable for wider battens on cruising catamarans.
- Price includes screws.

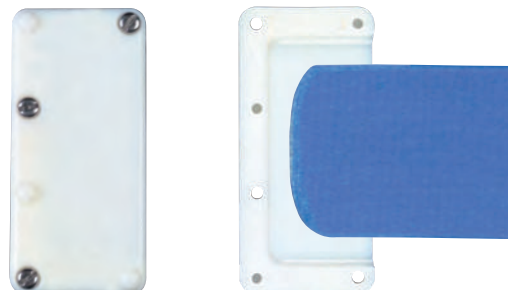

Part No.	Max Batten Width: mm/in		Max Cavity Depth: mm/in		Pack Qty
A005	60	2 3/8	30	1 5/16	10

Batten Pocket Elastic

- Manufactured from woven elastic which does not narrow under stretch.
- Polyester covering.
- Available only on full reels.

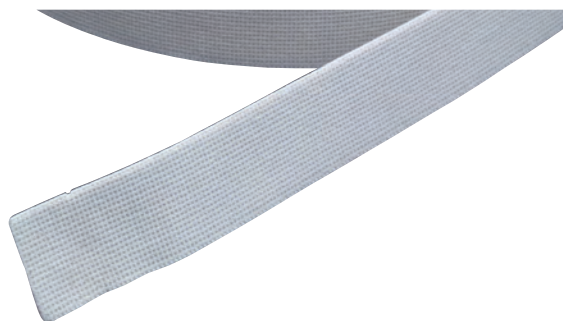

Part No.	Width: mm/in		Roll Length: m/yd	
E551	19	3/4	25	27
E552	25	1	25	27
E552LX300	25	1	300	274.2
E553	38	1 1/2	25	27

Batten Tensioners & End Fittings

End Fittings for Full Batten Yacht Sails

These fittings are recommended for use on simple designs of fully battened mainsails where the higher cost of more elaborate fittings is not justified. Batten tensioning is normally achieved by the use of leech end ties, webbing or Velcro.

End Fittings for 30mm/1 1/4" Flat Battens

- Manufactured in reinforced nylon, with type 316 stainless steel screws.
- Can be used as a leech fitting or luffbox with Allslip slides.
- Attaches to slide with webbing.
- Sold complete: 2 halves with screws and nuts.

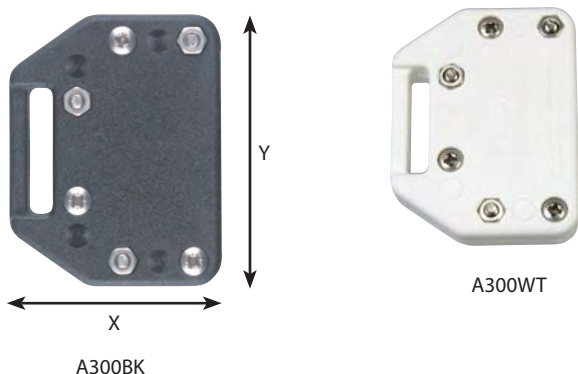

Part No.	Max Batten Size: mm/in	Max Cavity Depth: mm/in	X mm/in	Y mm/in
A300BK	30 x 6.5 1 1/4 x 1/4	40 1 1/2	43 1 11/16	55 2 1/8
A300WT	30 x 6.5 1 1/4 x 1/4	40 1 1/2	43 1 11/16	55 2 1/8

End Fittings for 45mm/1 3/4" Flat Battens

- Manufactured in reinforced nylon, with type 316 stainless steel screws.
- Can be used as a leech fitting or luffbox with Allslip slides.
- Attaches to slide with webbing or with shackle B303.
- Sold complete: 2 halves with screws and locking nuts.

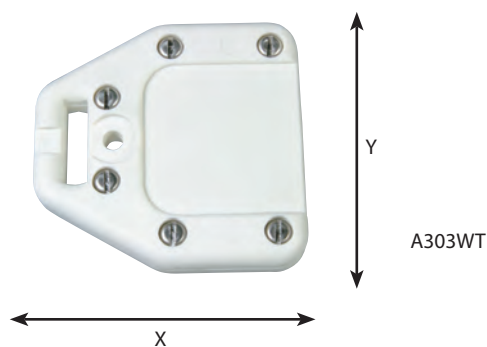
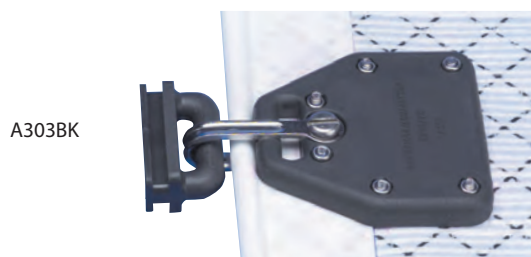

Part No.	Max Batten Size: mm/in	Max Cavity Depth: mm/in	X mm/in	Y mm/in
A303BK	46 x 7 1 3/4 x 1/4	47 1 3/4	80 3 1/8	76 3
A303WT	46 x 7 1 3/4 x 1/4	47 1 3/4	80 3 1/8	76 3

Shackle for Attachment of A303

- Manufactured from type 316 stainless steel fittings.
- Custom designed for use with A303.



Part No.	Length: mm/in	Width: mm/in
B303	42 1 5/8	12 1/2

Screw Compression Fitting

- Suitable for use with full batten mainsails on catamarans up to 6m/20 feet.
- Attach into size 00 grommets on each side of batten pocket.

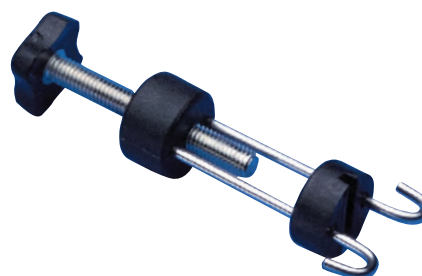

Part No.	Max Batten Thickness: mm/in	Pack Qty
A082	8 5/16	10

End Fittings for Round Battens

- Manufactured in reinforced nylon, with type 316 stainless steel fastenings.
- Can also be used as a leech fitting.
- Spare compression screws manufactured in type 316 stainless steel.
- A305 dimensions: 97mm x 44mm.
- A306 dimensions: 130mm x 55mm.



Part No.	Comprising	Use With
A305BK	Grey with backplate & attaching screws/nuts & compression screw	06R-12R
A305WT	White with backplate & attaching screws/nuts & compression screw	06R-12R
A305SS	Stainless steel screw	A305
A306BK	Grey with backplate & attaching screws/nuts & compression screw	16R-20R
A306WT	White with backplate & attaching screws/nuts & compression screw	16R-20R
A306SS	Stainless steel screw	A306

SDA Full Batten Fittings

SDA Fittings

These fittings, manufactured by SDA, are suitable for fully battened mainsails on boats up to 40 ft. Types are offered for either flat section or round section battens and all are compatible with a wide range of track slides including Sailman 3000, 4000 and 4000HD systems.

For Battens up to 25mm x 5mm

- Molded in reinforced nylon.
- All fittings are in type 316 stainless steel.
- Luff box connects to slide with M10 thread.
- Fitting dimensions: 100mm x 70mm.



Part No.	Comprising	Type
A443	Box, complete with backplate/top cover plate & attaching screws	Luff
A444	Box, complete with backplate/top cover plate & attaching screws compression screw & locknut	Leech

For Battens up to 40mm x 5mm

- Molded in reinforced nylon.
- All fittings are in type 316 stainless steel.
- Luff box connects to slide with M10 thread.
- Fitting dimensions: 100mm x 70mm.



Part No.	Comprising	Type
A453	Box, complete with backplate/top cover plate & attaching screws	Luff
A454	Box, complete with backplate/top cover plate & attaching screws compression screw & locknut	Leech

Micro Fittings for Battens up to 8mm Diameter

- Molded in reinforced nylon.
- All fittings are in type 316 stainless steel.
- Can be used as luff or leech box. Connects to slide with M10 thread.
- Fitting dimensions: 80mm x 38mm.



Part No.	Comprising	Type
A4081	Box, complete with backplate/attaching screws & nuts/compression screw	Leech/ Luff
A4082	Box, complete with backplate/attaching screws & nuts/compression screw	Luff

Small Fittings for Battens from 10mm to 12mm Diameter

- Molded in reinforced nylon.
- All fixings are in light-weight alloy.
- Luff box connects to slide with M10 thread.
- Fitting dimensions: A4122 - 65mm x 50mm
A4121 - 80mm x 50mm.



Part No.	Comprising	Type
A4122	Box, complete with backplate/attaching screws & nuts	Luff
A4121	Box, complete with backplate/attaching screws & nuts/compression screw	Leech
A4121S	Compression screw for A4121	-

Medium Fittings for Battens from 12mm to 16mm Diameter

- Molded in reinforced nylon.
- All fixings are in light-weight alloy.
- Luff box connects to slide with M10 thread.
- Fitting dimensions: A4162 - 80mm x 50mm
A4161 - 80mm x 50mm.



Part No.	Comprising	Type
A4162	Box, complete with backplate/attaching screws & nuts	Luff
A4161	Box, complete with backplate/attaching screws & nuts/compression screw	Leech
A4161S	Compression screw for A4161	-

Large Fittings for Battens from 16mm to 20mm Diameter

- Molded in reinforced nylon.
- All fixings are in light-weight alloy.
- Luff box connects to slide with M10 thread.
- Fitting dimensions: A4202 - 100mm x 50mm.
A4201 - 120mm x 50mm.

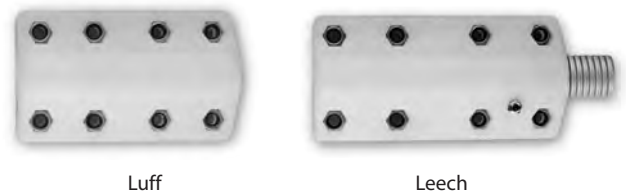

Part No.	Comprising	Type
A4202	Box, complete with backplate/attaching screws & nuts	Luff
A4201	Box, complete with backplate/attaching screws & nuts/compression screw	Leech
A4201S	Compression screw for A4201	-

SDA Full Batten Fittings

Couplings

- Cardan joint coupling features a heavy duty universal joint.



B720



B723

Part No.	Description	Attachment For Use With
B720	Cardan Joint Coupling	A419 - A423 Slide Pads
B723	Articulated Coupling	A419 - A423 Slide Pads

Slide Pads

- Machined from low friction plastic alloy.
- Price includes screws for fitting to B720/B723.



Part No.	Attachment For Use With	Length: mm/in	
A419	Masts with 19mm groove/B723/B720	70	2 ³ / ₄
A423	Masts with 24mm groove/B723/B720	77	3

Slides for Selden/Kemp Masts

- Designed to feed into Selden/Kemp gate.
- Pads accept pressure on aft face of mast.
- B431 is designed for use with the Sailman and SDA range of full batten boxes.
- Stainless steel toggle ensures universal articulation.



Part No.	Attachment For Use With	Connection
B431	Selden/Kemp Masts	M10

SDA Fittings Chart

Selected Batten Size	Mast Slide	Coupling	Connector	Luff Fitting	Plus	Leech Fitting
Up To 24mm Flat	A419-A423	B723	B722	A443	Plus	A444
	Sailman 3000	U00642				
	Sailman 4000	M10				
	B431					
Up To 40mm Flat	A419-A423	B723	B722	A453	Plus	A454
	Sailman 3000	U00642				
	Sailman 4000	M10				
	Sailman 5000	M10				
Up To 8mm Round	A419-A423	B720 B723	B722	A4081	Plus	A4081
	Sailman 3000	U00642				
	Sailman 4000	M10				
	Sailman 5000	M10				
Up To 12mm Round	A419-A423	B720 B723	B722	A4122	Plus	A4121
	Sailman 3000	U00642				
	Sailman 4000	M10				
	Sailman 5000	M10				
Up To 16mm Round	A419-A423	B720 B723	B722	A4162	Plus	A4161
	Sailman 4000	M10				
	Sailman 5000	M10				
Up To 20mm Round	A419-A423	B720	B722	A4202	Plus	A4201
	Sailman 5000	M10				
	B431	M10				

Track Slides

Track Slide Measurements

Bainbridge International's track slides have been carefully designed to allow compatibility with the widest possible range of mast sections. Design and material selection leads to trouble-free use and maximum strength even under the most arduous conditions. High strength metal slides are also available for each type of track to be used in the more highly stressed head and clew positions.

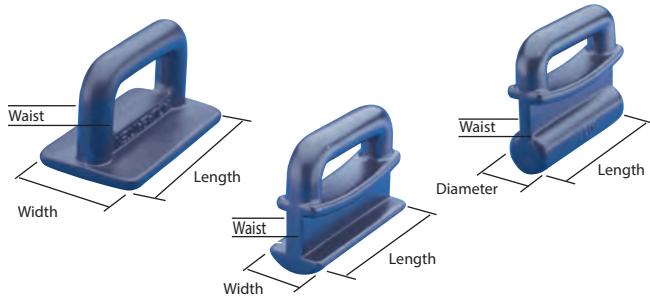

Internal Flat Slides - Plastic

- Injection molded in nylon 66.



Part No.	Width: mm/in	Waist: mm/in	Length: mm/in	Pack Qty
A007	15.5 5/8	6.5 1/4	30 1 3/16	10
A008	18.0 3/4	9.0 3/8	33 1 5/16	10
A009	22 7/8	11.0 7/16	35 1 3/8	10

Internal Flat Slides - Stainless Steel

- Cast stainless steel, electro-polished.
- Low friction PTFE coating.



Part No.	Width: mm/in	Waist: mm/in	Length: mm/in	Pack Qty
B307	16 5/8	7 1/4	38 1 7/16	10
B308	19.5 3/4	7 1/4	39 1 7/16	10
B309	22 7/8	7 1/4	38 1 7/16	10

Proctor Mast Slides

- Cast stainless steel encapsulated in low friction injection moulded nylon.



Part No.	Width: mm/in	Waist: mm/in	Length: mm/in	Pack Qty
B008	21 13/16	10 3/8	50 2	1
B009	24 15/16	11 7/16	50 2	1
B010	30.5 1 3/16	16 5/8	50 2	1

Holt Allen Slides - Plastic

- Alternate style to A009 slide.



Part No.	Width: mm/in	Waist: mm/in	Length: mm/in	Pack Qty
A0091	22 7/8	11 7/16	39 1 9/16	10

Metal Mast Slides - Plastic

- Designed for use in the Metal Mast system.



Part No.	Width: mm/in	Waist: mm/in	Size Reference	Pack Qty
A006M	20 3/4	10 3/8	6	Each
A008M	24 15/16	11 7/16	8	Each

Bronze Flat Internal Track Slides

- Designed for use in the Metal Mast system.
- Used at the headboard, clew outhaul or around/near luff reefings.



Part No.	Width: mm/in	Waist: mm/in	Size Reference	Pack Qty
B006	20 3/4	10 3/8	6	10
B008A	24 15/16	11 7/16	8	10

Allslop Internal Low Friction Slides

- Seven profiles to fit most modern spars.
- Precision moulded from glass fibre reinforced plastic with a PTFE impregnation.
- Overall length of 45mm gives good bearing surface.
- Positive location in mast groove for free running in compression and tension.
- A114 is specially designed for use in Selden Mast Sections fitted with flush gates.

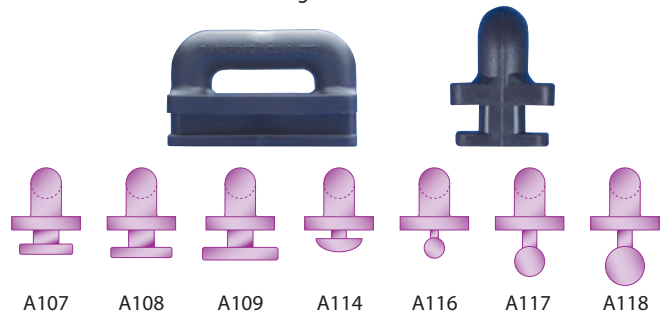

Part No.	Width: mm/in	Waist: mm/in	Length: mm/in	Pack Qty
A107	15.8 5/8	7.0 1/4	45 1 3/4	10
A108	19.0 3/4	9.0 3/8	45 1 3/4	10
A109	22.2 7/8	11.0 7/16	45 1 3/4	10
A114	15.5 5/8	4.4 3/16	45 1 3/4	10
A116	7.5 5/16	4.0 5/32	45 1 3/4	10
A117	8.5 3/8	4.0 5/32	45 1 3/4	10
A118	11.5 1/2	4.0 5/32	45 1 3/4	10

Selden Mast Slides - Plastic

- A011 and A012 are designed for Selden's range of sections.



Part No.	Width: mm/in	Waist: mm/in	Length: mm/in	Pack Qty
A011	19.5 $\frac{3}{4}$	8.5 $\frac{1}{3}$	29.0 $1 \frac{3}{16}$	10
A012	20 $\frac{3}{4}$	8.5 $\frac{1}{3}$	29.0 $1 \frac{5}{8}$	10



Part No.	Width: mm/in	Waist: mm/in	Length: mm/in	Pack Qty
A013	11 $\frac{7}{16}$	3 $\frac{1}{8}$	24 $\frac{7}{8}$	10
A014	14 $\frac{9}{16}$	4 $\frac{5}{32}$	30 $1 \frac{3}{16}$	10
A015	14.5 $\frac{5}{8}$	4 $\frac{5}{32}$	40 $1 \frac{5}{8}$	10

Selden Mast Slides - Stainless Steel

- Cast stainless steel, electro-polished.
- Low friction PTFE coating.



Part No.	Width: mm/in	Waist: mm/in	Length: mm/in	Pack Qty
B044	13 $\frac{9}{16}$	3 $\frac{9}{32}$	37 $1 \frac{7}{16}$	1

Internal Slug Slides - Stainless Steel

- Cast stainless steel, electro-polished.
- Low friction PTFE coating.



Part No.	Width: mm/in	Waist: mm/in	Length: mm/in	Pack Qty
B035	7.5 $\frac{5}{16}$	3.5 $\frac{5}{32}$	37 $1 \frac{7}{16}$	1
B036	8.6 $\frac{5}{16}$	3.5 $\frac{5}{32}$	37 $1 \frac{7}{16}$	1
B037	10.5 $\frac{7}{16}$	3.5 $\frac{5}{32}$	37 $1 \frac{7}{16}$	1

Internal Slug Slides - Plastic

- Injection moulded in nylon 66.
- A019 is injection moulded in nylon 6.



Part No.	Width: mm/in	Waist: mm/in	Length: mm/in	Pack Qty
A016	7.5 $\frac{5}{16}$	3 $\frac{1}{8}$	27 $1 \frac{1}{16}$	10
A017	9 $\frac{3}{8}$	3 $\frac{1}{8}$	27 $1 \frac{1}{16}$	10
A018	12 $\frac{1}{2}$	3 $\frac{1}{8}$	27 $1 \frac{1}{16}$	10
A019	14.0 $\frac{9}{16}$	3 $\frac{1}{8}$	25 1	10

Slug Slides with Welded Stainless Steel Bail

- Moulded-in welded bail gives maximum strength.



Part No.	Width: mm/in	Waist: mm/in	Length: mm/in	Pack Qty
A016S	6.9 $\frac{9}{32}$	2.5 $\frac{3}{32}$	27 $1 \frac{1}{16}$	10
A017S	8 $\frac{5}{16}$	2.5 $\frac{3}{32}$	27 $1 \frac{1}{16}$	10
A019S	10.0 $\frac{13}{32}$	3.4 $\frac{1}{8}$	30 $1 \frac{1}{16}$	10
A018S	11.0 $\frac{7}{16}$	3.4 $\frac{1}{8}$	30 $1 \frac{1}{16}$	10

Heavy Duty Slug Slides with Moulded-In Stainless Steel Bail

- Injection moulded in low friction nylon, with captive stainless steel bail.
- A031C is designed for modern dinghy booms with very narrow groove openings.
- Also used for mainsail tack to give close-in attachment of sail to mast.



Part No.	Width: mm/in	Waist: mm/in	Length: mm/in	Pack Qty
A031C	8 $\frac{5}{16}$	1.7 $\frac{1}{16}$	50 2	1
A031	8 $\frac{5}{16}$	3 $\frac{1}{8}$	50 2	1
A032	9 $\frac{3}{8}$	3 $\frac{1}{8}$	51 2	1
A033	12 $\frac{1}{2}$	4 $\frac{5}{32}$	73 3	1

Track Slides

Internal Slug Slides - Cast Alloy

- Diecast in aluminum alloy and coated with teflon.



Part No.	Diameter: mm/in		Waist: mm/in		Length: mm/in		Pack Qty
B101	11	$\frac{7}{16}$	2.6	$\frac{3}{32}$	38	$1\frac{1}{2}$	1
B102	11	$\frac{7}{16}$	4	$\frac{5}{32}$	72	$2\frac{7}{8}$	1
B103	12	$\frac{15}{32}$	4	$\frac{5}{32}$	78	$3\frac{1}{16}$	1

Heavy Duty Slug Slides - Stainless Steel

- Diecast in stainless steel, electro-polished.
- Low friction PTFE coating.

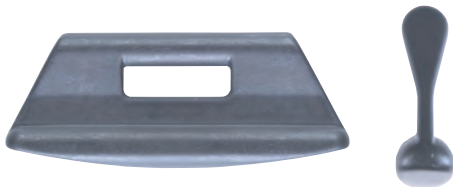

Part No.	Diameter: mm/in		Waist: mm/in		Length: mm/in		Pack Qty
B011	7.5	$\frac{5}{16}$	3	$\frac{1}{8}$	74	$2\frac{3}{8}$	1
B012	9	$\frac{3}{8}$	3	$\frac{1}{8}$	75	$2\frac{3}{8}$	1
B013	12.2	$\frac{1}{2}$	3	$\frac{1}{8}$	75	$2\frac{3}{8}$	1

External Slides - Stainless Steel

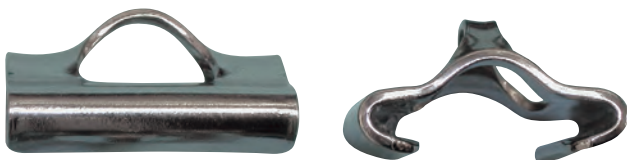

Part No.	Track Size: mm/in		Pack Qty
B014SS	15.0	$\frac{5}{8}$	10
B015SS	22	$\frac{7}{8}$	10
B016SS	25	1	10

Kiwi Slides

- Easily installed by sewing directly onto the sail. No shackles required.
- Can be used in groove headstay systems.



Part No.	Diameter: mm/in		Length: mm/in		Pack Qty
A310	5.6	$\frac{7}{32}$	33	$\frac{15}{16}$	10
A313	8.0	$\frac{5}{16}$	33	$\frac{15}{16}$	10
A315	10.0	$\frac{3}{8}$	33	$\frac{15}{16}$	10

External Slides - Cast Bronze

- Traditional style slides for sail or "T" track.
- Ideal for webbing onto sail.
- Use where greater strength is required, such as head and clew areas of mainsails.

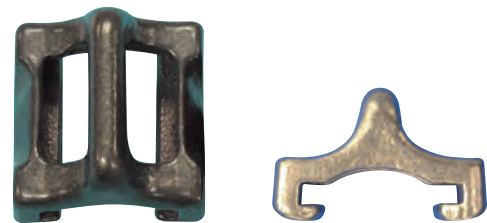

Part No.	Track Size: mm/in		Pack Qty
Q110	22.2	$\frac{7}{8}$	10

Plastic Mast Hoops

- Easily snaps together without tools.
- Most commonly used with Sunfish, Sailfish, Vikings or other Lateen rigged boats.



Part No.	Description	Pack Qty
A029	Sail Ring for 1 1/2" Tube	10

Mast Hoop Sail Fasteners

- Two-part fasteners, one male to sew on to the sail, the other female to attach to mast hoop.
- Use flat head wood screws to attach female section of fastener to mast hoop.
- Male part is attached to sail with either sailtwine or waxed hand sewing thread.

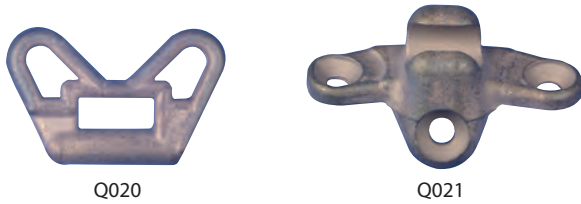

Part No.	Description	Pack Qty
Q020	Male	10
Q021	Female	10

Screw-on Shackles - Plastic

Bainbridge International's plastic shackles are designed for ease of use, high strength and ability to absorb shock loads. The screw design is strongest and permits easy detachment and re-attachment.

- Injection molded from a tough nylon to absorb sudden impact loads.
- A027 to be used with A007/A008/A013/A016/A017/A018/A019/A006M.
- A026/A028 to be used with A009/A014/A018.
- Shackles supplied complete with screws.



A027



A026

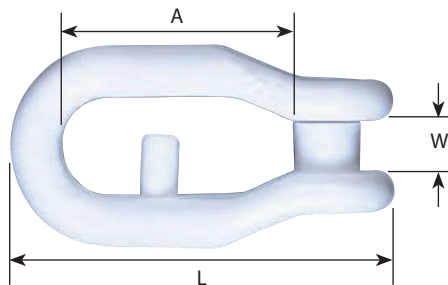

A028

Part No.	Description	A: mm/in	L: mm/in	W: mm/in	Pack Qty
A027	Small/Standard	28 1 1/8	45 1 3/4	10 3/8	10
A026	Large/Standard	27 1 1/16	47 1 7/8	11 7/16	10
A028	Large/Anti-Jamming	27 1 1/16	47 1 7/8	11 7/16	10

Snap-in Shackles - Plastic

Bainbridge International's plastic shackles are designed for ease of use, high strength and ability to absorb shock loads. The unique snap design is often preferred as an easier to fit alternative.

- Injection molded from a tough nylon to absorb sudden impact loads.
- Unique design of snap to give reduced elongation under load and higher strength.
- A022/A023 to be used with A007/A008/A013/A016/A017.
- A021/A024 to be used with A009/A014/A018.

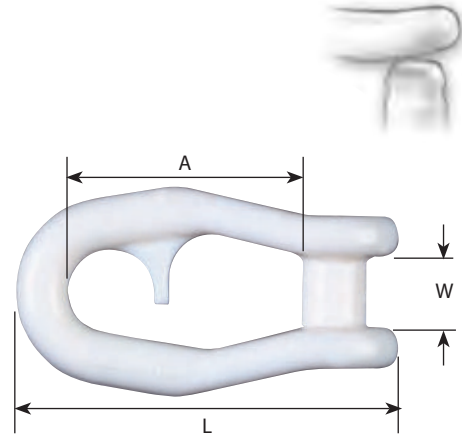

Part No.	Description	A: mm/in	L: mm/in	W: mm/in	Pack Qty
A022	Small/Standard	22 7/8	39 1 9/16	10 3/8	10
A021	Large/Standard	28 1 1/8	45 1 3/4	11 7/16	10
A023	Small/Anti-Jamming	22 7/8	39 1 9/16	10 3/8	10
A024	Large/Anti-Jamming	28 1 1/8	45 1 3/4	11 7/16	10

Long Reach Screw-On Shackles

The long reach shackle is specifically designed for connecting our regular plastic and Allslip slides to full batten sails including those equipped with the Sailman 3000 system.

- A035BK to be used with all 7 Allslip slides as well as: A007, A008, A009, A017 and A018.
- Unique anti-jamming design retains the slide at the head of the shackle.
- Colour co-ordinated to match Sailman and Allslip slides.
- Screw-on closure for extra strength, supplied complete.

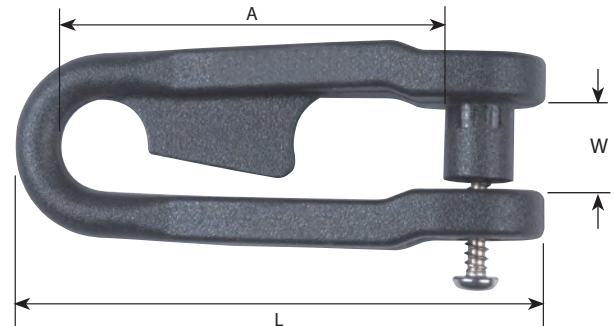

Part No.	A: mm/in	L: mm/in	W: mm/in	Pack Qty
A035BK	45 1 3/4	61 2 13/32	11 7/8	1

Shackles

Screw-on Shackles - Plastic

- A030N can be used with B014 slide or many other slides.
- A030N is thin and light weight. A030W is thick and heavy weight.

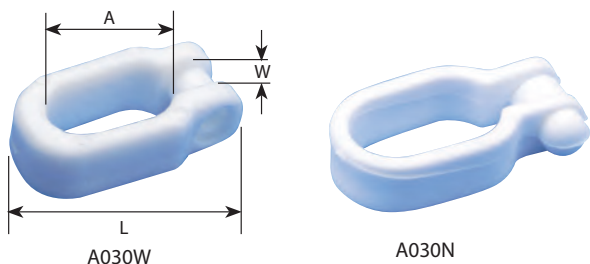

Part No.	Description	A: mm/in	L: mm/in	W: mm/in	Pack Qty
A030N	Narrow	18 1 ¹ / ₁₆	25 1	4 5 ³ / ₃₂	10
A030W	Wide	15 5 ⁸ / ₈	25 1	4 5 ³ / ₃₂	10

Screw Shackles - Stainless Steel

- B129, B130, B131 all have rolled edges to reduce chafe.

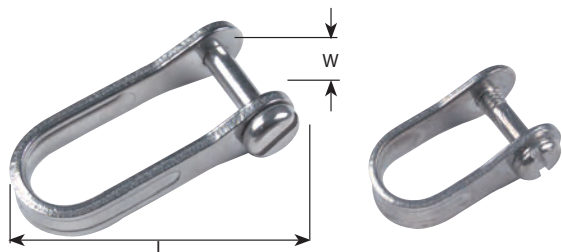

Part No.	To Be Used With	L: mm/in	W: mm/in	Pack Qty
B129	A016S - A018S & B014 - B016	16 5 ⁸ / ₈	10 3 ⁸ / ₈	10
B130	A016S - A018S & B014 - B016	20 3 ⁴ / ₄	10 3 ⁸ / ₈	10
B131	A016S - A018S & B014 - B016	24 1 ¹ / ₈	10 3 ⁸ / ₈	10
B110	A031 - A033 & B307 - B309	34 15 ¹ / ₁₆	15 5 ⁸ / ₈	10

Shackle Protectors

- Cut from clear vinyl.
- Available only in full packs of 100.

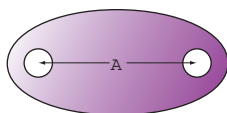

Part No.	To Be Used With	Dimension (A): mm/in	Pack Qty
A515	B129	34 1 5 ¹ / ₁₆	100
A516	B130	37 1 7 ¹ / ₁₆	100
A517	B131	51 2	100
A518	B110	59 2 5 ¹ / ₁₆	100

Sister Clips & Brummel Hooks

- Allows fast and positive sheet attachment to sail.
- Use on one-design or light air spinnakers.



B605



B606

Part No.	Description	Length: mm/in	Pack Qty
B605	Stainless Steel with Ferrule	38 1 1 ¹ / ₂	1
B606	Aluminum Alloy (Holt Allen 74)	35 1 3 ⁸ / ₈	10

Bronze Sew-on Jib Snaps

- These traditional style jib snaps are sewn onto the foresail.



Part No.	Size	Length: mm/in	Wire Diameter: mm/in	Pack Qty
B411	1	50 2	8 5 ¹ / ₁₆	1
B412	2	63 2 1 ¹ / ₂	11 7 ¹ / ₁₆	1
B413	3	70 2 3 ⁴ / ₄	12 1 ¹ / ₂	1
B414	4	95 3 3 ⁴ / ₄	15 5 ⁸ / ₈	1

Wichard Stainless Steel Tack Hooks

- Standard type.
- Working loads shown are according to manufacturer's data and is dependent on application.



B536



B528/29



B518/19/20



B535/38

Part No.	Wichard #	Length: mm/in	Safe Working Load: kg/lb	Pack Qty
B536	81432	37 1 29 ⁶ / ₆₄	400 881	1
B518	2480	50 1 15 ¹ / ₁₆	200 441	1
B519	2481	75 2 15 ¹ / ₁₆	480 1058	1
B520	2482	100 3 15 ¹ / ₁₆	1120 2469	1
B528	2381	75 2 15 ¹ / ₁₆	880 1940	1
B529	2382	100 3 15 ¹ / ₁₆	1680 3704	1
B535	2675	90 3 35 ⁶ / ₆₄	1600 3527	1
B538	2678	150 5 29 ³ / ₃₂	5200 11464	1

Tylaska Tack Shackles

- Specifically designed for application, using 25mm/1 inch webbing to attach to sail.
- Operation is one handed even under maximum 1800kg/4000lb working load.

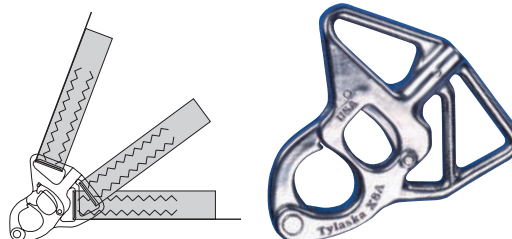

Part No.	Length: mm/in	Safe Working Load: kg/lb
B710	73 2 7 ⁸ / ₈	1800 4000

Wichard Stainless Steel Tack Hooks

- Carbine type.
- Working loads shown are according to manufacturer's data and is dependent on application.



Part No.	Wichard #	Length: mm/in		Safe Working Load: kg/lb		Pack Qty
B531	2313	60	2 3/8	360	794	1
B532	2315	80	3 1/8	880	1940	1
B533	2316	100	3 15/16	1200	2646	1

Twist-On Plastic Jib Hanks

Plastic jib hanks are ideal for dinghies, dayboats and sportsboats up to 25 feet.

- Prices include screws.



A038

A039

Part No.	Size	Forestay Diameter: mm/in		Pack Qty
A038	Small	3.5	5/32	10
A039	Large	5.0	7/32	10

Plastic Piston Jib Hanks

- Ideal for sportsboats and daysailers such as J24 and 1720.



Part No.	Length: mm/in	Max Forestay: mm/in	Pack Qty
A188A	50 2	6.4 1/4	10

Wichard Stainless Steel Jib Hanks



Part No.	Wichard #	Length: mm/in		Max. Forestay: mm/in		Pack Qty
B506	2486	50	2	7.5	5/16	1
B504	2483	55	2 1/8	9	3/8	1
B507	2487	65	2 1/2	11	7/16	1
B505	2489	80	3 1/8	13	1/2	1
B508	2488	90	3 1/2	17	5/8	1

Swedish Forged Brass Piston Hanks

Swedish brass jib hanks are renowned world-wide for quality, reliability and ease of fitting.

- Forged from marine quality brass and fitted with a stainless steel spring.
- B516 has a jaw opening of 25mm and internal dimensions of 25mm x 29mm. It is designed for use over forestay systems for storm jibs, not for large genoas.



Part No.	Size	Length: mm/in		Max. Forestay: mm/in		Pack Qty
B510	0	44	1 3/4	8	5/16	10
B511	1	52	2	9	3/8	10
B512	2	65	2 1/2	12	1/2	10
B513	3	74	2 7/8	15	5/8	10
B514	4	82	3 1/4	17	11/16	10
B515	5	95	3 3/4	20	13/16	10
B516	6	107	4 1/4			10

Wichard Bronze Jib Hanks



Part No.	Wichard #	Length: mm/in		Max. Forestay: mm/in		Pack Qty
B701	72486	50	2	7.5	5/16	1
B702	72483	55	2 1/8	9	3/8	1
B703	72487	65	2 1/2	11	7/16	1

Jib Hank Protectors

- Cut from clear vinyl.
- Available only in full packs of 100.



Part No.	To Be Used With	Pack Qty
A511	B506/B510/B511/B701	10
A512	B504/B507/B512/B702/B703	10
A513	B505/B513	10
A514	B508/B514/B515	10

Outhaul Blocks & Clew Blocks

Offshore Reef Block

Designed for offshore applications including racing and performance cruising. Block can easily be removed from sail and disassembled for servicing.

- Applications up to 75ft.
- Turned Ertalyte sheave takes rope up to 14mm.
- High load bearing system.
- Large attaching bar for 25mm webbing.



Part No.	Sheave	Rope Size: mm/in	SWL: kg/lb	Boat Size
B089	70 3 3/4	14 1/2	3000 6600	75ft Max



Mainsail Outhaul Blocks

A range of mainsail outhaul blocks is available to suit boat sizes up to 25 meters. They are an increasingly popular alternative to a fixed clew ring on roller furling mains. They are easily attached to the sail by the use of webbing straps.

- Manufactured in silver anodized, marine grade aluminum and fitted with high performance Kemetal sheaves with carbon fibre rollers.
- Plastic bushes protect webbing from abrasion on B092/3/7.



B091/93/97



B0901

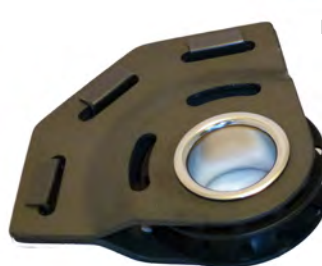

B0902



B0903

Part No.	Sheave: mm/in	Rope Size: mm/in	SWL: kg/lb	Boat Size
B091	42 1 5/8	8 5/16	625 1350	23-32ft
B092	50 1 31/32	10 3/8	750 1650	23-39ft
B093	70 2 3/4	12 1/2	1750 3850	32-52ft
B097	100 3 15/16	14 9/16	1750 3850	46-59ft
B0901	51 2 1/64	14 9/16	453 999	23-32ft
B0902	76 3	16 41/64	1360 2992	23-39ft
B0903	95 3 3/4	16 41/64	1587 3491	32-52ft



Dinghy Headboards

Clewboards - Aluminium

- Gold anodized aluminum.
- Use D337/D339 Rivets.

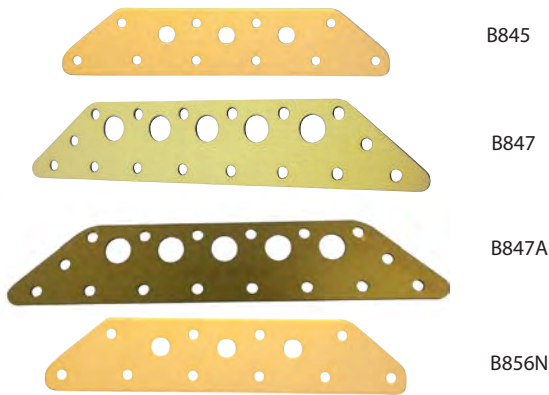

Part No.	Length: mm/in	Width: mm/in	Thickness: mm/in	Pack Qty
B845	140 5 1/2	29 1 1/8	1.6 1/16	1
B847	203 8	38 1 1/2	1.6 1/16	1
B847A	203 8	38 1 1/2	1.6 1/16	1
B856N	140 5 1/2	29 1 1/8	1.6 1/16	1

Dinghy Headboards - Plastic

Plastic headboards meet all major dinghy classes rules and are made from rigid nylon.

- Suitable for a wide range of One Design classes.
- Manufactured from a rigid grade of nylon to give maximum leech support.
- Use D037 liners and D331 rivets. (5/32 inch).



Part No.	Width: mm/in	Length: mm/in	Pack Qty
A043	75 3	100 4	10
A044	100 4	115 4 1/2	10
A049	115 4 1/2	130 5 1/2	10

Dinghy Headboards - Plastic

Plastic headboards meet all major dinghy classes rules and are made from rigid nylon.

- Suitable for a wide range of OK dinghy classes.
- Manufactured from a rigid grade of nylon to give maximum leech support.
- Use D037 liners and D331 rivets.

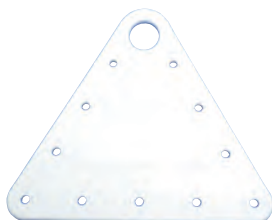

Part No.	Width: mm/in	Length: mm/in	Pack Qty
A045	150 5.9	150 5.9	10

Dinghy Headboards - Plastic

Plastic headboards meet all major dinghy classes rules and are made from rigid nylon.

- Suitable for Finn/Fireball/Snipe etc.
- Manufactured from a rigid grade of nylon to give maximum leech support.
- Use D037 liners and D331 rivets. (5/32 inch).



Part No.	Width: mm/in	Length: mm/in	Pack Qty
A048	145 6	145 6	10

Dinghy Headboards - Aluminum

- B805 Suitable for Finn Classes.
- B806 Suitable for OK Classes.
- These headboards use D335/D337 rivets.
- Gold anodized aluminum.

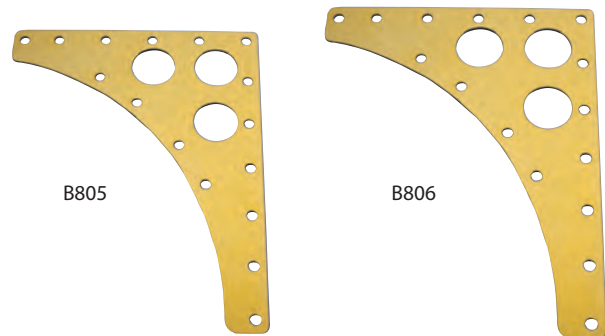

Part No.	Width: mm/in	Length: mm/in	Thickness: mm/in	Pack Qty
B805	135 5.31	185 7.28	1.6 1/16	1
B806	140 5.52	135 5.31	1.5 5/64	1

Dinghy Headboards - Aluminum

- Suitable for Dragon Classes.
- This headboard uses D335/D337 rivets.
- Blue anodized aluminum.



Part No.	Width: mm/in	Length: mm/in	Thickness: mm/in	Pack Qty
B907N	105 4 9/64	115 4 17/32	1.6 5/64	1

Yacht Headboards

Yacht Headboards - Aluminium

New manufacturing system ensures an extra smooth finish. Burrs that can often wear through webbing and sharp edges that abrade cloth are virtually eliminated.

- Dual halyard position.
- Manufactured from marine grade aluminium.
- Use D039 liners and D335 - D339 rivets.
- Webbing slot for slide attachment.



Part No.	Width: mm/in	Length: mm/in	Thickness: mm/in	Colour	Pack Qty
B908	89 3.50	123 4.84	1.6 0.06	Gold	1
B908N	89 3.50	123 4.84	1.6 0.06	Blue	1
B909	102 4.02	130 5.12	1.6 0.06	Gold	1
B909N	102 4.02	130 5.12	1.6 0.06	Blue	1
B909SR	102 4.02	130 5.12	1.6 0.06	Silver	1

Other colours of anodised headboards can be supplied against special order. All special order items are subject to minimum order quantities and additional lead times. Prices on application.



Yacht Headboards - Aluminium

New manufacturing system ensures an extra smooth finish. Burrs that can often wear through webbing and sharp edges that abrade cloth are virtually eliminated.

- Dual halyard position.
- Manufactured from marine grade aluminium.
- Use D039 liners and D335 - D339 rivets.
- Webbing slot for slide attachment.
- Also available in silver. Add SR to part number ie. B910SR.

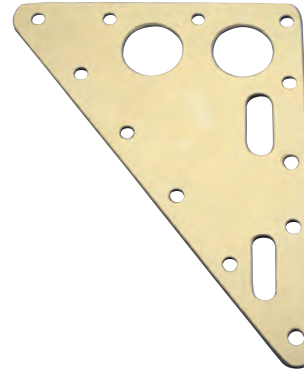

Part No.	Width: mm/in	Length: mm/in	Thickness: mm/in	Colour	Pack Qty
B910	115 4.53	146 5.75	1.6 0.06	Gold	1
B910N	115 4.53	146 5.75	1.6 0.06	Blue	1
B910SR	115 4.53	146 5.75	1.6 0.06	Silver	1
B911	115 4.53	146 5.75	3.2 0.13	Gold	1
B911N	115 4.53	146 5.75	3.2 0.13	Blue	1
B911SR	115 4.53	146 5.75	3.2 0.13	Silver	1
B914	133 5.24	165 6.47	1.6 0.06	Gold	1
B914N	133 5.24	165 6.47	1.6 0.06	Blue	1
B912	133 5.24	165 6.47	3.2 0.13	Gold	1
B912N	133 5.24	165 6.47	3.2 0.13	Blue	1
B912SR	133 5.24	165 6.47	3.2 0.13	Silver	1
B913	153 6.02	195 7.68	3.2 0.13	Gold	1
B913N	153 6.02	195 7.68	3.2 0.13	Blue	1
B913SR	153 6.02	195 7.68	3.2 0.13	Blue	1

Yacht Headboards - Aluminium

New manufacturing system ensures an extra smooth finish. Burrs that can often wear through webbing and sharp edges that abrade cloth are virtually eliminated.

- Dual halyard position.
- Manufactured from marine grade aluminium.
- Use D039 liners and D335 - D339 rivets.
- Luff, leech and double slide webbing slots.

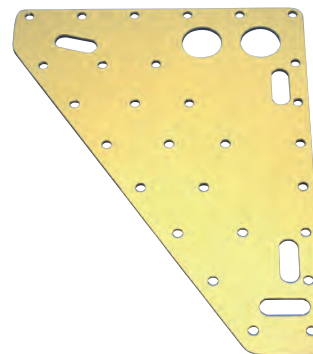

Part No.	Width: mm/in	Length: mm/in	Thickness: mm/in	Colour	Pack Qty
B915	178 7.01	227 8.94	3.2 0.13	Gold	1
B915N	178 7.01	227 8.94	3.2 0.13	Blue	1
B817	216 8.50	267 10.51	3.2 0.13	Gold	1

Yacht Headboards

Yacht Headboards - Plastic

Plastic headboards meet all major dinghy class rules and are made from rigid nylon.

- Moulded from ultra rigid glass-filled nylon.
- Smoothly rounded edges and webbing slot give no sail chafe.
- Smoothly rounded liner hole permits liner to sit flat.
- These headboards use D038 liners and D335 - D339 rivets.



Part No.	Width: mm/in		Length: mm/in		Thickness: mm/in		Pack Qty
A052	115	4.53	140	5.51	3.5	0.14	10
A053	133	5.24	163	6.42	4.0	0.16	10

Yacht Headboards - Aluminum

- Dual halyard position.
- Manufactured in marine grade aluminum.
- Use $\frac{7}{8}$ inch liners and $\frac{3}{16}$ inch rivets.
- Luff and leech webbing slots for reinforcing high load areas of mainsail.
- Gold anodizing.



Part No.	Width: mm/in		Length: mm/in		Thickness: mm/in		Pack Qty
B814	133	5 $\frac{1}{4}$	165	6 $\frac{1}{2}$	2	$\frac{1}{16}$	1
B818	152	6	152	6	2	$\frac{1}{16}$	1
B816	152	6	200	7 $\frac{7}{8}$	2	$\frac{1}{16}$	1
B813	152	6	200	7 $\frac{7}{8}$	3	$\frac{1}{8}$	1

Yacht Headboards - Aluminum

- Dual halyard position.
- Manufactured in marine grade aluminum.
- Use $\frac{7}{8}$ inch liners and $\frac{3}{16}$ inch rivets.
- Luff and leech webbing slots for reinforcing high load areas of mainsail.
- Gold anodizing.



Part No.	Width: mm/in		Length: mm/in		Thickness: mm/in		Pack Qty
B815	184	7 $\frac{1}{4}$	229	9	3	$\frac{1}{8}$	1
B817	216	8 $\frac{1}{2}$	267	10 $\frac{1}{2}$	3	$\frac{1}{8}$	1

Yacht Headboards - Aluminum Open Centre

- Use $\frac{7}{8}$ inch liners and $\frac{3}{16}$ inch rivets.
- Because of the open center design, these headboards reduce weight aloft where it is critical.
- Luff and leech webbing slots for reinforcing high load areas of mainsail.
- Gold anodizing.



Part No.	Width: mm/in		Length: mm/in		Thickness: mm/in		Pack Qty
B825	184	7 $\frac{1}{4}$	229	9	3	$\frac{1}{8}$	1
B827	216	8 $\frac{1}{2}$	267	10 $\frac{1}{2}$	3	$\frac{1}{8}$	1

Yacht Headboards

Hollow Centre Aluminium Headboards

These new hollow centre designs reduce weight. They are fixed to the sail with a minimal number of rivets and 3 liners. The result is a quicker to fit and higher strength, head assembly. For even more strength webbing can be sewn through the liners.

Our new production system ensures a smooth and high quality finish.

- Lighter.
- Stronger.
- Quick to fix.
- Web through liners for extra strength.
- Smooth aluminium construction.
- Use D335 - D339 rivets and D039 liners.

Single Slot Hollow Centre



Part No.	Width: mm/in	Length: mm/in	Thickness: mm/in	Colour	Pack Qty
B921BK	106 4 ³ / ₁₆	127 5	1.8 ¹ / ₁₆	Black	10
B921SR	106 4 ³ / ₁₆	127 5	1.8 ¹ / ₁₆	Silver	10

Double Slot Hollow Centre

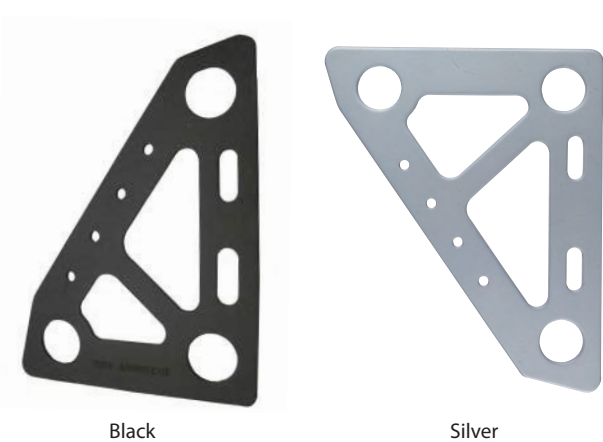

Part No.	Width: mm/in	Length: mm/in	Thickness: mm/in	Colour	Pack Qty
B926BK	127 5	168 6 ¹ / ₂	2.8 ¹ / ₈	Black	10
B926SR	127 5	168 6 ¹ / ₂	2.8 ¹ / ₈	Silver	10
B927BK	150 5 ⁷ / ₈	184 7 ¹ / ₄	2.8 ¹ / ₈	Black	10
B927SR	150 5 ⁷ / ₈	184 7 ¹ / ₄	2.8 ¹ / ₈	Silver	10

Full Batten Headboards

Designed specifically for full batten sails including those fitted with Sailman systems.

- Web through liners for extra strength.
- Smooth aluminium construction.
- New manufacturing system ensures an extra smooth finish. Burrs that can often wear through webbing and sharp edges that abrade cloth are virtually eliminated.

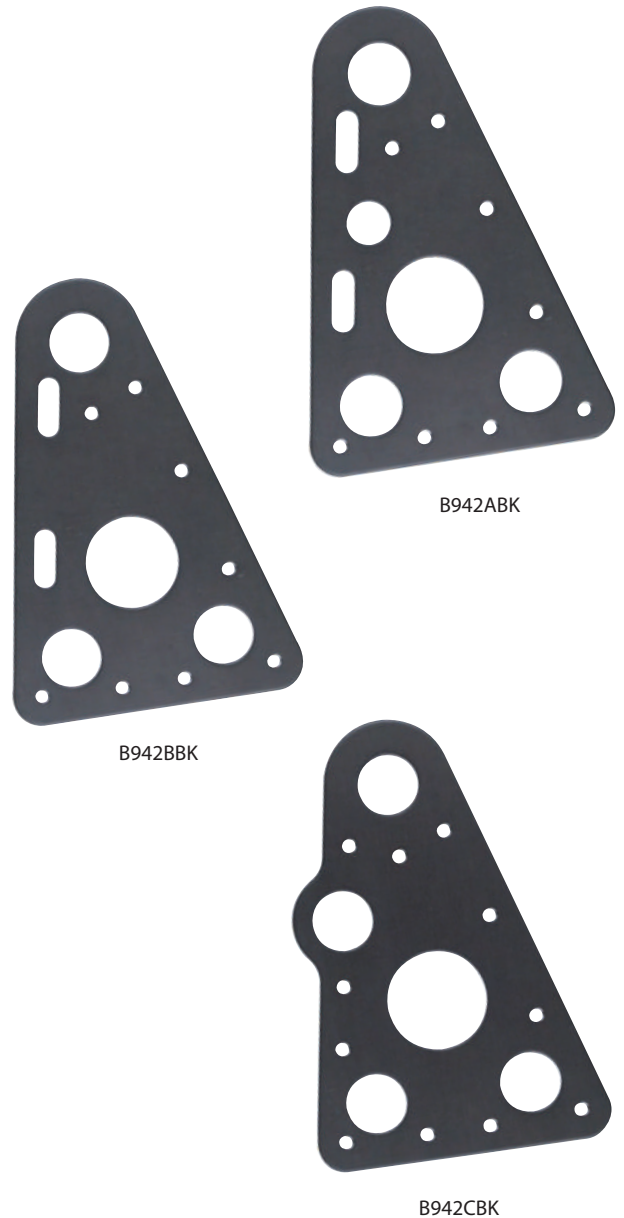

Part No.	Width: mm/in	Length: mm/in	Thickness: mm/in	Colour	Pack Qty
B942ABK	116 4 ¹ / ₂	175 6 ⁷ / ₈	2.8 ¹ / ₈	Black	1
B942BBK	116 4 ¹ / ₂	175 6 ⁷ / ₈	2.8 ¹ / ₈	Black	1
B942CBK	116 4 ¹ / ₂	175 6 ⁷ / ₈	2.8 ¹ / ₈	Black	1

Other colours of anodised headboards can be supplied against special order. All special order items are subject to minimum order quantities and additional lead times. Prices on application.



Headboard Liners & Rivets

Aluminum Clew Boards

- Colour: Black.
- Use $\frac{1}{8}$ inch thick clew boards for boats over 30 feet.
- Use $\frac{5}{8}$ inch liners and $\frac{3}{16}$ inch rivets.

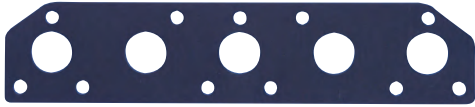

Part No.	Length: mm/in		Width: mm/in		Thickness: mm/in		Pack Qty
B931BK	191	7 1/2	38	1 1/2	2	1/8	1
B936BK	241	9 1/2	38	1 1/2	2	1/8	1

Aluminum Clew Boards

- Color: Gold.
- Use $\frac{3}{16}$ inch rivets.
- For use in big boat applications.

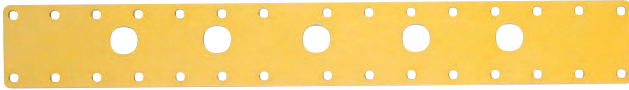

Part No.	Length: mm/in		Width: mm/in		Thickness: mm/in		Pack Qty
B918	381	15	51	2	3	3/16	1

Headboard Liners

- Manufactured from brass with nickel plated finish.
- D039S manufactured from type 316 stainless steel.

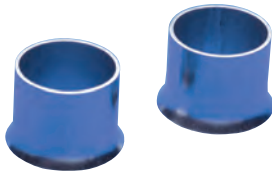

Part No.	Diameter: mm/in		Length: mm/in		Closing Tool	Pack Qty
D037N	16	5/8	16	5/8	C321	10
D039N	22	7/8	19	3/4	C323	10
D039S	22	7/8	19	3/4	C323	10

Closing Tools for Headboard Liner

- Use just the two piece closing tool for setting with hydraulic press.
- Add the handle and set liners by hand with mallet.
- 3 pieces sold complete.

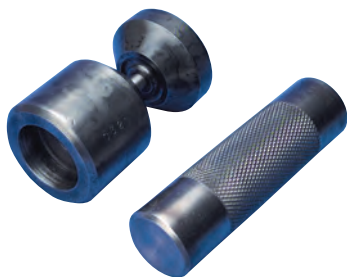

Part No.	Use with Headboard Liners
C321	D037N
C322	D038
C323	D039N, D039S

Semi-Tubular Aluminum Rivets

- Available only in full pack of 1000.



Part No.	Diameter: mm/in		Length: mm/in		Closing Tool	Hole Punch	Pack Qty
D332	3.2	1/8	9.5	3/8	C324	C101	1000
D333	3.2	1/8	12.7	1/2	C324	C101	1000
D331	3.9	5/32	9.5	3/8	C325	C102	1000
D334	3.9	5/32	12.7	1/2	C325	C102	1000
D335	4.8	3/16	9.5	3/8	C326	C103	1000
D337	4.8	3/16	12.7	1/2	C326	C103	1000
D339	4.8	3/16	15.9	5/8	C326	C103	1000

Closing Tools for Semi-Tubular Rivets

- For best results hit closing tools with a rawhide mallet against a steel or aluminum plate. Do not use steel head hammer or mallet.



Part No.	Use For
C324	D331 - D334 (1/8 inch to 5/32 inch)
C325	D331 - D334 (1/8 inch to 5/32 inch)
C326	D335 - D339 (3/16 inch)

Tubular Brass Rivets

- D380 - D384 rivets are sold in full packs only. 100 pieces per pack.



Part No.	Use For	Diameter: mm/in		Length: mm/in		Mfg #
D380	—	3.0	1/8	11	7/16	A546
D382	B808 - B810 B814, B816, B818	5.0	3/16	11	7/16	613

Clamcleat® Rope Cleats



The Clamcleat principle is simple. A ridged 'V' groove holds rope firmly, yet is devoid of any moving parts to break or seize. It allows the immediate release of the rope by a short downward pull. Always tension the rope before it enters the cleat to avoid damage to the cleat.

Leechline Cleat - Port Side

- A057 - Low profile white nylon cleat, for sewing or riveting onto sails and technical fabrics. It can be mounted in two positions on the sail.
- The tooth design allows a quick, positive lock that is easy to release, added to its low profile it is an ideal cleat for adjusting leech lines.
- The aluminium version of this cleat is the B057. If you require a cleat for the other side of a sail please look at A067.
- A057BP - Use a backplate when riveting a cleat onto fabric as it will prevent the rivet pulling through.



A058



A057

Comes with BP & Rivets



Part No.	Clamcleat #	Assembly	Leechline Size: mm/in	Pack Qty
A057	CL212	Cleat/Backplate/Rivets	2 - 5 1/16 - 3/16	10
A057A	CL212	Cleat Only White	2 - 5 1/16 - 3/16	10
A057ABK	CL213	Cleat Only Black	2 - 5 1/16 - 3/16	10
A057BP	CL212BP	Backplate for A057 A067/B301/B057/B067		10
A058	CL212A	Cover for A057/A057A		10

Use tool C324 for rivets

Racing Fine Line Cleat - Port Side

- B057 - The tooth design allows a quick, positive lock that is easy to release, add this to its low profile and ability to hold high loads, it makes an ideal cleat for adjusting leech lines on larger sails. Use a back plate when riveting a cleat onto fabric to prevent the rivet pulling through.
- It can be mounted in two positions and can be sewn or riveted to the sail. Manufactured from aluminium for light weight and durable performance the B057 is available in two finishes:
- B057 has a silver stove enamel finish for a cost effective, high quality coating.
- B057AN has a hard anodised finish to give the ultimate hard wearing surface.
- The nylon version of this cleat is the A057. For the other side of a sail please look at nylon A067 or alloy B057.



A058



B057

Comes with BP & Rivets



Part No.	Clamcleat #	Assembly	Leechline Size: mm/in	Pack Qty
B057	CL258	Cleat/Backplate/Rivets	3 - 6 1/8 - 1/4	10
B057A	CL258	Cleat Only	3 - 6 1/8 - 1/4	10
B057AN	CL258AN+PR	Cleat/Backplate/Rivets	3 - 6 1/8 - 1/4	10
A057BP	CL212BP	Backplate for A057 A067/B301/B057/B067		10
A058	CL212A	Cover for A057/A057A		10

Racing Sail Line Cleat - Starboard Side

- The tooth design allows a quick, positive lock that is easy to release, add to this its low profile and ability to hold high loads, makes it ideal for tensioning leech line on larger sails.
- The integrated rope guide also makes it suitable for adjusting and securing reefing points.
- Manufactured from aluminium for light weight and durable performance it can be mounted in two positions.
- A060 has a silver stove enamel finish for a cost effective, high quality finish.
- A068 has a hard anodised finish to give the ultimate hard wearing surface.
- The other version of this cleat is the B301.



A060



A068

Part No.	Clamcleat #	Assembly	Leechline Size: mm/in	Pack Qty
A060	CL273	Cleat only	3 - 6 1/8 - 1/4	10
A068	CL273AN	Cleat only	3 - 6 1/8 - 1/4	10

Clamcleat® Rope Cleats

Racing Sail Line Cleat - Port Side

- B301 - The tooth design allows a quick, positive lock that is easy to release, add to this its low profile and ability to hold high loads, makes it ideal for tensioning leech line on larger sails.
- The integrated rope guide makes it suitable for adjusting & securing reefing points.
- Manufactured from aluminium for light weight and durable performance it can be mounted in two positions.
- B301 has a silver stove enamel finish for a cost effective, high quality finish.
- B301AN has a hard anodised finish to give the ultimate hard wearing surface.
- The Starboard version of this cleat is A060. The plastic equivalent version of this cleat is the A063A. Use a back plate when riveting a cleat onto fabric as it will prevent the rivet pulling through.



Part No.	Clamcleat #	Assembly	Leechline Size: mm/in		Pack Qty
B301	CL241+PR	Cleat/Backplate/Rivets	3 - 6	1/8 - 1/4	10
B301A	CL241	Cleat Only	3 - 6	1/8 - 1/4	10
B301AN	CL241AN+PR	Cleat Only	3 - 6	1/8 - 1/4	10
A057BP	CL212BP	Backplate for A057 A067/B301/B057/B067			10

Racing Fine Line Cleat - Starboard Side

- B067 - The tooth design allows a quick, positive lock that is easy to release, add this to its low profile and ability to hold high loads, it makes an ideal cleat for adjusting leech lines on larger sails. Use a back plate when riveting a cleat onto fabric to prevent the rivet pulling through.
- It can be mounted in two positions and can be sewn or riveted to the sail. Manufactured from aluminium for light weight and durable performance the B067 is available in two finishes:
- B067 has a silver stove enamel finish for a cost effective, high quality coating.
- B067AN has a hard anodised finish to give the ultimate hard wearing surface.
- The nylon version of this cleat is the A067. For the other side of a sail please look at nylon A057 or alloy B057.



Part No.	Clamcleat #	Assembly	Leechline Size: mm/in		Pack Qty
B067	CL259+PR	Cleat/Backplate/Rivets	3 - 6	1/8 - 1/4	10
B067A	CL259	Cleat Only	3 - 6	1/8 - 1/4	10
B067AN	CL259AN+PR	Cleat Only	3 - 6	1/8 - 1/4	10
A057BP	CL212BP	Backplate for A057 A067/B301/B057/B067			10

Leechline Cleat - Starboard Side

- A067 - Low profile nylon cleat, for sewing or riveting onto sails and technical fabrics. It can be mounted in two positions on the sail.
- The tooth design allows a quick, positive lock that is easy to release, added to its low profile it is an ideal cleat for adjusting leech lines.
- The aluminium version of this cleat is the B067. If you require a cleat for the other side of a sail please look at B301.
- Use a back plate A057BP when riveting a cleat onto fabric as it will prevent the rivet pulling through.



Part No.	Clamcleat #	Assembly	Leechline Size: mm/in		Pack Qty
A067	CL214	Cleat/Backplate/Rivets	2 - 5	1/16 - 3/16	10
A067A	CL214	Cleat Only	2 - 5	1/16 - 3/16	10
A057BP	CL212BP	Backplate for A057 A067/B301/B057/B067			10

Sail Line Cleat

- The cleat's low profile and smooth snag free shape makes it ideal for mounting onto the edges of sails to tension leech line and jib luffs.
- For sewing onto sails and technical fabrics, back plates are available A063BP. The aluminium equivalent to the A063A is a B301.



Part No.	Clamcleat #	Assembly	Leechline Size: mm/in		Pack Qty
A063A	CL233	Cleat only	2 - 6	1/16 - 1/4	10
A063BP	CL233BP	Backplate for A063A			10

Clamcleat® Rope Cleats

Racing Sail Edge Cleat

- Fits on the edge of a sail. Low profile nylon casing with a strong aluminium cleat.
- Semi-flexible sides make it easy to fit to the sail.
- Adjust from either side of the sail.
- Strong and impact resistant.
- Also available as an all-nylon cleat – A066.

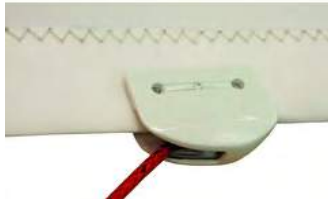

A061



A061A

Part No.	Clamcleat #	Assembly	Leechline Size: mm/in	Pack Qty
A061	CL267+PR	Cleat & Rivets	2 - 4 1/16 - 5/32	10
A061A	CL267	Cleat only	2 - 4 1/16 - 5/32	10



Sail Edge Cleat

- Fits on the edge of a sail. Low profile all-nylon cleat.
- Semi-flexible sides make it easy to fit to the sail.
- Adjust from either side of the sail.
- Strong and impact resistant.
- Also available as an all-nylon cleat – A066.



A066



A066A

Part No.	Clamcleat #	Assembly	Leechline Size: mm/in	Pack Qty
A066	CL269+PR	Cleat & Rivets	2 - 4 1/16 - 5/32	10
A066A	CL269	Cleat only	2 - 4 1/16 - 5/32	10



Dinghy Leechline Cleat



A056
Comes with BP,
Cover & Rivets

Part No.	Clamcleat #	Assembly	Leechline Size: mm/in	Pack Qty
A056	CL221	Cleat/Backplate/Rivets	Up to 3 Up to 1/8	10



Kitesurfing/Aero Cleat

- A compact aluminium cleat for brake lines.
- Easy to rig and adjust. The position of the cleat on the rope can be adjusted by hand. No tools required.



Part No.	Clamcleat #	Description	Leechline Size: mm/in	Pack Qty
B302	CL826-11AN/R	Aero Cleat Hard Anodised	4 - 6 5/32 - 1/4	10



LINE-LOK Tent Cleat

- Manufactured from a material that improves its performance the colder it gets, this cleat is the ideal choice for holding guylines in winter conditions. The cleat's design locks the rope so it will not slip in windy conditions yet is easy to release.
- Ideal for tents, caravan awnings, gazebos, bashas, shelters and radio masts and aerials.



Part No.	Clamcleat #	Description	Leechline Size: mm/in	Pack Qty
A080BK	CL260B	Cleat Only Black	2 - 5 1/16 - 3/16	10



Leechline Cleats

Clamcleat Applications

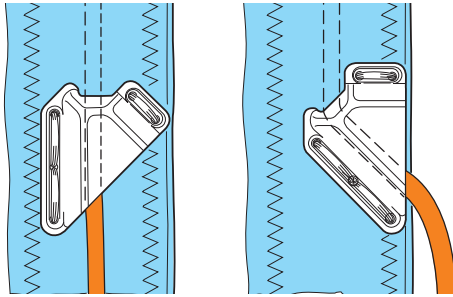

A063A

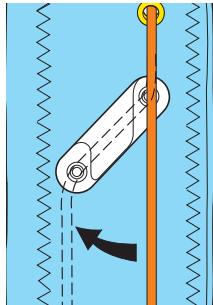

A057

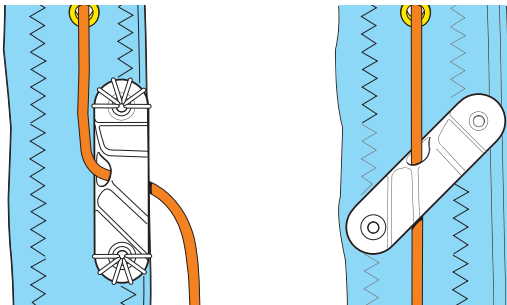

B301

B301 alternative position.
Typical mainsail reef application

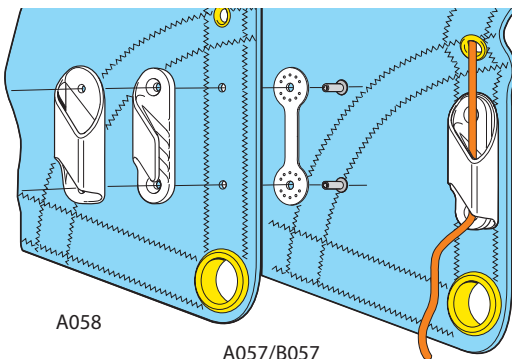

A058

A057/B057

Fender / Large Loop Cleat

- The A083BK makes it simple to hang fenders. It is easy to adjust so your fenders are always positioned correctly. The cleat stays on the rope so nothing gets lost. There are no moving parts and it fits all sizes of tube or wire. The tooth design allows a positive grip on the rope that is easy to release making it ideal for tensioning nets, radio masts, tents and fenders.
- Other colours are available on request.



Part No.	Clamcleat #	Description	Leechline Size: mm/in	Pack Qty
A083BK	CL234B	Cleat Only Black	6 - 11 1/4 - 7/16	10

Gransegel Cleats

Alternative to the popular Clamcleat leechline cleats, the Gransegel design has the unique feature of fitting compactly around the sail leech.

- Compact and lightweight fitting.



Part No.	Length: mm/in	Leechline Size: mm/in	Pack Qty
A054	29 1.14	1.5 - 2.0 1/16	10
A055	44 1.73	1.5 - 4.0 1/16 - 9/32	10
A059	58 2.28	2.0 - 4.0 1/16 - 9/32	10

Regular Cleats

- Injection moulded in nylon.
- Rivets and backplate included.
- Only available in full packs.



Part No.	Length: mm/in	Leechline Size: mm/in	Pack Qty
A062	For riveting/sewing	1.5 - 3.0 1/16 - 1/8	10

Luff Tape

- Headfoil and mast extrusions can vary dimensionally and it is recommended that a short piece of luff tape is tried in the profile before it is sewn to the sail.
- Every effort is made to identify and exclude all faults, but please check the length required for a sail before commencing sewing.
- Luff tapes are manufactured in nominal 100 metre rolls.



Bainbridge 'Super Luff' Tape

- Coloured stitching for easy size recognition and simplicity.
- High quality hard braid rope.
- Accurate stitching through genuine Bainbridge Sailcloth.
- Consistent sizes for accuracy.
- Specific sizes measured to give optimum ease of hoist.
- Packaged in a slim box for ease of handling and storage around the loft.

Red -
up to 5mm

Green -
up to 6mm

Blue -
up to 7mm

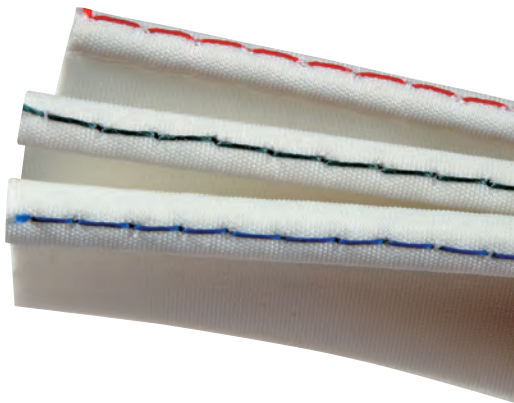

'Super Luff' Tape - Single

- Manufactured with first quality 7smoz/300gsm x 100mm tape, sewn as indicated.

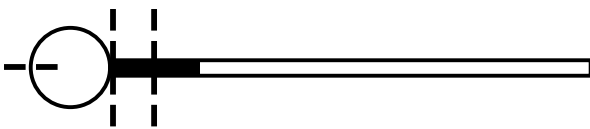

Part No.	Description	Colour	Finished Size: mm	Rope Configuration	Reel Length: m
L401	Size 5 Single Cord Luff Tape	Red	Up to 5mm	Single	100
L402	Size 6 Single Cord Luff Tape	Green	Up to 6mm	Single	100
L403	Size 7 Single Cord Luff Tape	Blue	Up to 7mm	Single	100



When ordering luff tape, customers should establish that the size they specify is compatible with the headfoil/mast system for which it is to be used.

'Super Luff' Tape - Double

- Manufactured with first quality 7smoz/300gsm x 125mm tape, sewn as indicated.

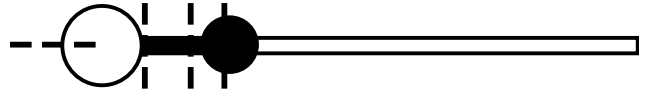

Part No.	Description	Colour	Finished Size: mm	Rope Configuration	Reel Length: m
L441	Size 5 Double Cord Luff Tape	Red	Up to 5mm	Double	100
L442	Size 6 Double Cord Luff Tape	Green	Up to 6mm	Double	100
L443	Size 7 Double Cord Luff Tape	Blue	Up to 7mm	Double	100



Slim boxes for ease of storage.

Mainsail Luff Tape

- Metric sized 3-strand pre-stretched polyester rope.
- Manufactured with first quality 214gsm/5smoz x 80mm tape, sewn as indicated.
- Other sizes of bolt rope are also available.

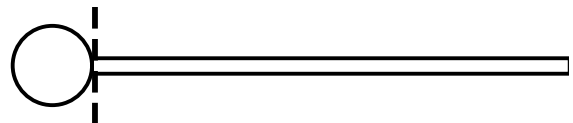

Part No.	Rope Diameter: mm
L150	7
L152	9

Cut lengths available for the items featured on this page. Please enquire for details.

Custom Luff Tape styles are available to special order. All special items are subject to minimum order quantities and additional lead times. Prices on application.



Luff Tape & Luff Foam

Triple Cord 'Gemini'

- Imperial sized hard braid luffline.
- Manufactured with first quality 300gsm/7smoz x 125mm tape, sewn as indicated.

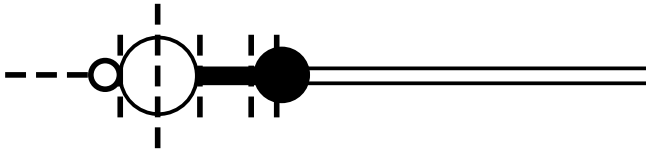

Part No.	Rope Diameter: mm/in	
LU600	3.2 and 5.5	$\frac{1}{8}$ and $\frac{7}{32}$

Roller Furling Luff Foam

Foam used to reduce camber (draft) of roller furling sail when partially furled.

- Foam padding flattens sail when furled.
- Flatter sail reduces heeling and makes boat easier to steer.
- Easy to cut.
- Does not absorb water.
- Only available on full rolls.

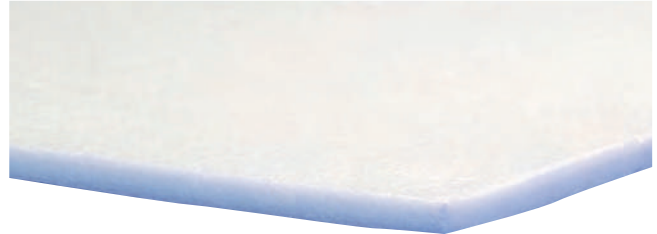

Part No.	Thickness: mm/in		Width: mm/in		Roll Length: m/ft	
LR001025	5.0	$\frac{3}{16}$	1000	39	25	82



Sailcloth Tape

Polyester Sailcloth Tape

- Hot slit to seal the edges.
- All rolls are 100 metres nominal. Available on full rolls only.



Part No.	Weight: gsm / smoz		Width: mm/in	
S40025	170	4.0	25	1.0
S40040	170	4.0	40	1.6
S40045	170	4.0	45	1.8
S40050	170	4.0	50	2.0
S40060	170	4.0	60	2.4
S40063	170	4.0	63	2.5
S40070	170	4.0	70	2.8
S40075	170	4.0	75	3.0
S40080	170	4.0	80	3.2
S40100	170	4.0	100	3.9
S50040	215	5.0	40	1.6
S50050	215	5.0	50	2.0
S50060	215	5.0	60	2.4
S50063	215	5.0	63	2.5
S50070	215	5.0	70	2.8
S50075	215	5.0	75	3.0
S50080	215	5.0	80	3.2
S50090	215	5.0	90	3.5
S50100	215	5.0	100	3.9
S50125	215	5.0	125	4.9
S50350	215	5.0	350	13.8
S60040	255	6.0	40	1.6
S60060	255	6.0	60	2.4
S60063	255	6.0	63	2.5
S60070	255	6.0	70	2.8
S60080	255	6.0	80	3.2
S60090	255	6.0	90	3.5
S60100	255	6.0	100	3.9
S60120	255	6.0	120	4.7
S60125	255	6.0	125	4.9
S60150	255	6.0	150	5.9
S70060	300	7.0	60	2.4
S70063	300	7.0	63	2.5
S70070	300	7.0	70	2.8
S70075	300	7.0	75	3.0
S70080	300	7.0	80	3.2
S70090	300	7.0	90	3.5
S70100	300	7.0	100	3.9
S70120	300	7.0	120	4.7
S70125	300	7.0	125	4.9
S70150	300	7.0	150	5.9
S70175	300	7.0	175	6.9
S80060	343	8.0	60	2.4
S80075	343	8.0	75	3.0
S80100	343	8.0	100	3.9
S80125	343	8.0	125	4.9
S80150	343	8.0	150	5.9
S80200	343	8.0	200	7.9

Profilen® PTFE Tape

- Profilen® PTFE yarns are woven into fabric to reduce friction when used in the manufacture of luff tapes.
- Hot slit to seal the edges.
- All rolls are approximately 100metres/109 yards.
- Cut lengths available on request.



Part No.	Weight: gsm / smoz		Width: mm/in	
S80080T	343	8.0	80	3
S80100T	343	8.0	100	4
S80125T	343	8.0	125	4.9

Folded Tape

- Available against special order only.
- Pre-folded tape can be prepared from most slit polyester or nylon tapes.
- The folded tapes are placed on special reels fo facilitate easy storage and handling.

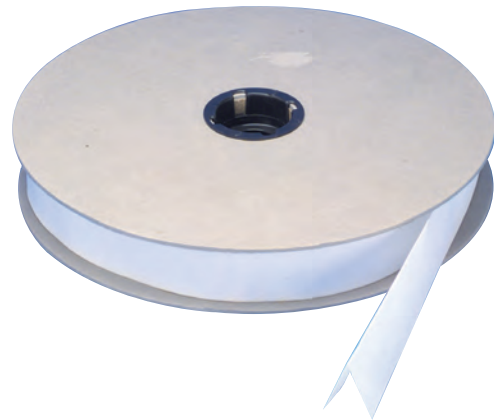

Other weights and widths can be supplied against special order and all weights and widths can be folded. All special order items are subject to minimum order quantities and additional lead times. Prices on application.



Polyester Coloured Sailcloth Tape

- These tapes are manufactured from Ocean 455 180gsm/4.2smoz polyester sailcloth.
- Hot slit to seal the edges.
- All rolls are 80/100 metres nominal. Available only on full rolls.



Part No.	Colour	Width: mm/in	
T39025BK	Black	25	1
T39025RD	Red	25	1
T39025GR	Green	25	1
T39025BU	Blue	25	1
T39040RD	Red	40	1.6
T39040GR	Green	40	1.6
T39040BU	Blue	40	1.6
T39040BK	Black	40	1.6
T39050RD	Red	50	2
T39050GR	Green	50	2
T39050BU	Blue	50	2
T39050BK	Black	50	2
T39060RD	Red	60	3
T39060GR	Green	60	3
T39060BU	Blue	60	3
T39060BK	Black	60	3
T39075RD	Red	75	3
T39075GR	Green	75	3
T39075BU	Blue	75	3
T39075BK	Black	75	3
T39080RD	Red	80	3
T39080GR	Green	80	3
T39080BU	Blue	80	3
T39080BK	Black	80	3

Custom Slitting

- Save time.
- Almost any fabric can be slit.
- Your choice of widths.
- Cold slit.
- Hot slit to seal edges.
- Inquire for details.



Nylon Spinnaker Edging Tape

- These tapes are manufactured from 170gsm/4smoz nylon.
- Other weights/widths/colours can be supplied. Please inquire.
- Hot slit to seal the edges.
- All rolls are 80/100 metres nominal. Available only on full rolls.



Part No.	Width: mm/in		Colour
T025RD	25	1.0	Red
T025GR	25	1.0	Green
T025WT	25	1.0	White
T040RD	40	1.6	Red
T040GR	40	1.6	Green
T040WT	40	1.6	White
T050RD	50	2.0	Red
T050GR	50	2.0	Green
T050WT	50	2.0	White
T060RD	60	2.4	Red
T060GR	60	2.4	Green
T060WT	60	2.4	White
T075RD	75	3.0	Red
T075GR	75	3.0	Green
T075WT	75	3.0	White
T080RD	80	3.1	Red
T080GR	80	3.1	Green
T080WT	80	3.1	White

Other weights and widths can be supplied against special order and all weights and widths can be folded. All special order items are subject to minimum order quantities and additional lead times. Prices on application.



Ropes

Metric Extruded Vinyl Rope

- Manufactured to metric sizes for European designed systems.
- Maintains dimensional stability.
- Use for economy headsail luff tape.
- Available only on full reels.



Part No.	Diameter: mm/in		Reel Length: m/yd	
E491R	4	$\frac{3}{16}$	100	109
E492R	5	$\frac{13}{64}$	100	109
E493R	6	$\frac{1}{4}$	100	109
E494R	7	$\frac{9}{32}$	100	109

Metric & Imperial Hard Braid Luffline

Hard section lufflines in metric and imperial sizes designed for maintaining their cross-sectional shape in luff tapes to facilitate smooth hoisting and lowering of the sail.

- Hard braided to maintain shape and size.
- Use for headsail luff tape.
- Available only on full reels.

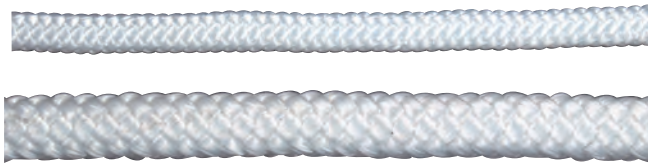

Part No.	Type	Diameter: mm/in		Reel Length: m/yd	
E451	Metric	4	$\frac{3}{16}$	100	109
E452	Metric	5	$\frac{13}{64}$	100	109
E453	Metric	6	$\frac{1}{4}$	100	109
E454	Metric	7	$\frac{9}{32}$	100	109
E455	Metric	8	$\frac{5}{16}$	100	109

Part No.	Type	Diameter: mm/in		Reel Length: m/yd		Tracer Colour
E461	Imperial	3.9	$\frac{5}{32}$	366	400	Orange/Black
E462L	Imperial	4.8	$\frac{3}{16}$	640	700	Black
E463	Imperial	5.6	$\frac{7}{32}$	792	866	Orange
E464L	Imperial	6.3	$\frac{1}{4}$	548	600	Yellow/Black

Polynite 3-Strand Boltrope

- Low stretch, low shrink polypropylene construction.
- Hard construction for excellent shape retention.
- Available only on full reels.



Part No.	Diameter: mm/in		Reel Length: m/yd	
E392	6	$\frac{1}{4}$	200	218
E393	7	$\frac{9}{32}$	200	218
E394	8	$\frac{5}{16}$	200	218
E397	10	$\frac{3}{8}$	200	218

Staple Polyester 3-Strand Boltrope

- Use as mainsail boltrope where medium stretch and excellent return is required.
- Available only on full reels.

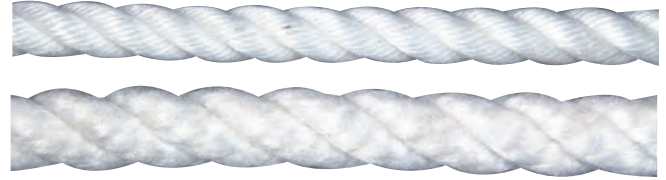

Part No.	Diameter: mm/in		Reel Length: m/yd	
E401	6	$\frac{1}{4}$	200	218
E403	8	$\frac{5}{16}$	200	218

Polyester Pre-Stretched Boltrope

- Use as mainsail boltrope where medium stretch and excellent return is required.
- Available only on full reels.

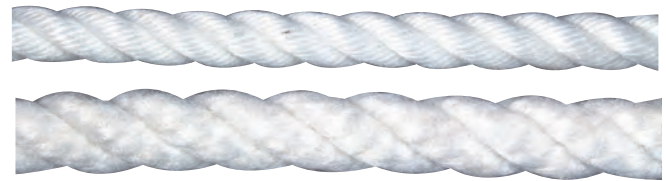

Part No.	Diameter: mm/in		Reel Length: m/yd	
E441	7	$\frac{9}{32}$	200	218
E443	9	$\frac{23}{64}$	200	218

Braided Polyester Leechline/Bag Draw Cord

- Economy line for leechline, drawcord and general applications.
- Only available on full reels.

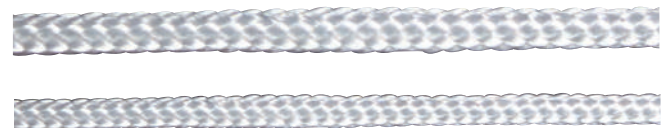

Part No.	Diameter: mm/in		Reel Length: m/yd	
E432	2	$\frac{3}{32}$	100	109
E434	3	$\frac{1}{8}$	100	109
E435	4	$\frac{1}{6}$	100	109

Technora® Aramid Leechline

- Very low stretch.
- Improved flex life compared to most aramid ropes.
- Polyester outer protects Technora core.
- Only available on full reels.



Part No.	Diameter: mm/in		Reel Length: m/yd	
E345	1.7	$\frac{1}{16}$	500	546
E347	3	$\frac{1}{8}$	330	360
E351	4	$\frac{3}{16}$	220	240
E352	6	$\frac{1}{4}$	270	295

Shockcord Fittings

Coated Dyneema Leechline

- 100% Dyneema construction with polyurethane coating.
- Special construction allows reliable cleating in Clamcleat and GranSegel products without the need to stitch on an outer sheathing.
- Very low stretch and no water absorption.
- Only available on full reels.



Part No.	Diameter: mm/in		Reel Length: m/yd	
E361	3	$\frac{1}{8}$	200	218
E362	4	$\frac{3}{16}$	200	218
E363	5	$\frac{13}{64}$	200	218
E364	6	$\frac{1}{4}$	200	218

Shockcord

- Nylon covered synthetic rubber for longer life.
- Available only on full reels.

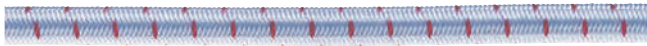

Part No.	Diameter: mm	Construction	Colour	Reel Length: m
RSESC03WRD	3	Polyester	White/Red	250
RSESC04WRD	4	Polyester	White/Red	100
RSESC05WRD	5	Polyester	White/Red	100
RSESC06WRD	6	Polyester	White/Red	100
RSESC08WRD	8	Polyester	White/Red	100

Marlow

Log on to our e-shop

www.bainbridgeint.com

to browse and buy the full range of
Marlow ropes!



Barrel Lock

- Simple cord locking device designed with a positive locking stainless steel spring.
- Slip the cord into hole and the spring lock holds the cord tight.
- Use on draw strings, small sailbags to lock cord.



Part No.	Maximum Cord Size: mm/in		Pack Qty
A105	6.3	$\frac{1}{4}$	Each

Cord Lock

- Use on draw strings for bags.
- Two-part simple cam action.



Part No.	Colour	Maximum Cord Size: mm/in		Pack Qty
A106BK	Black	3	$\frac{1}{8}$	Each

Nylon Inglefield Hooks

These nylon hooks are ideal for securing covers etc. With shock cord can be made to loop around items such a sails on a boom.



Part No.	Colour	Maximum Cord Size: mm/in		Pack Qty
A550BK	Black	8	$\frac{5}{16}$	Pair

Shockcord Clamps

- Stainless steel clamps.
- Use Pliers C449 to apply, see below.
- Available only in full packs of 100.
- Order quantity: 1 full pack equals 100 clamps.



Part No.	For Cord Diameter: mm/in		Size
B449	3 - 5	$\frac{1}{8}$ - $\frac{3}{16}$	X00
B450	6	$\frac{1}{4}$	X0
B451	8	$\frac{5}{16}$	X1
B452	10	$\frac{3}{8}$	X2
B453	12	$\frac{1}{2}$	X3

Shockcord Fittings

Shockcord Pliers

- For closing clamps B449 - B453.



Part No.	Description
C449	Clamp Pliers

Stainless Steel Shockcord Hooks

- Place shockcord through bottom hole. Squeeze shock cord clamp tightly.



Part No.	For Cord Diameter: mm/in	Length:	Pack Qty
B461	6 $\frac{1}{4}$	50 2	Each
B462	8 $\frac{5}{16}$	62 2 $\frac{1}{2}$	Each

Plastic Shockcord Hooks

- White nylon.



A101

A102

Part No.	For Cord Diameter: mm/in	Length:	Pack Qty
A101	3 - 6 $\frac{1}{8}$ - $\frac{1}{4}$	36 1 $\frac{7}{16}$	Each
A102	8 - 10 $\frac{5}{16}$ - $\frac{3}{8}$	63 2 $\frac{1}{2}$	Each

Plastic Locking Shock Cord Hook

Two-part hook with locking cover secures shock cord to hook without separate clamps or knots

- Use for tie down cords.



Part No.	Cord Diameter: mm/in	Length: mm/in	Color	Pack Qty
A140	6 $\frac{1}{4}$	45 1 $\frac{3}{4}$	Black Delrin	Each
A141	8 $\frac{5}{16}$	73 2 $\frac{7}{8}$	Black Nylon	Each

"S" Hook Shockcord Hooks

- Stainless steel wire.



Part No.	Wire Diameter: mm/in	Length: mm/in	Pack Qty
B463	3.2 $\frac{1}{8}$	31 1 $\frac{1}{4}$	Each
B464	4.8 $\frac{3}{16}$	44 1 $\frac{3}{4}$	Each

Shock Cord to Webbing Connector

- Connector to link 6mm shock cord to 38mm webbing.
- Black Delrin.



Part No.	Cord Diameter: mm/in	Length: mm/in	Pack Qty
A145BK	6 $\frac{1}{4}$	38 1	Each

Shockcord Fittings

Plastic Shock Cord End

- Fits 6mm shock cord.
- Use for tie down cords etc.



Part No.	Cord Diameter: mm/in		Length: mm/in		Pack Qty
A147BK	6	1/4	38	1	Each

Stainless Steel Thimbles

Bainbridge International's sailmakers solid thimbles are manufactured from heavy gauge type 316 stainless steel, and are chemically cleaned and/or electropolished after manufacture for maximum distortion, strength and long lasting appearance.

- Manufactured in grade 316 stainless steel especially for sailmaking.
- Jointless design of solid thimbles give maximum strength even under twisting loads. Rounded small end permits seizing/binding with no risk of chafing.



Split B133-40



Solid B153-8

Part No.	External Length: mm/in		Inside Dia: mm/in		Wire Dia: mm/in		Pack Qty
B133	24	1 5/16	10	3/8	3	1/8	10
B134	26	1	12	7/16	4	5/32	10
B135	32	1 1/4	14	9/16	5	3/16	10
B136	39	1 1/2	16	5/8	6	1/4	10
B137	45	1 3/4	20	13/16	7	5/16	1
B138	51	2	22	7/8	8	3/8	1
B140	59	2 5/16	25	1	10	7/16	1
B153	28	1 1/8	12	7/16	3	1/8	10
B154	33	1 3/8	15	9/16	4	5/32	10
B155	36	1 7/16	18	1 1/16	5	3/16	10
B156	48	1 7/8	20	3/4	6	1/4	10
B158	56	2 1/4	24	1	8	5/16	10

Nicropress Sleeves

- Zinc plated copper sleeves.
- Manufactured to imperial sizes.
- Closing tools available against special order.



Part No.	Wire Size: mm/in		Pack Qty
B542N	2.0	1/16	100
B543N	2.5	3/32	100
B544N	3.0	1/8	100
B545N	4.0	5/32	100
B549N	6.0	1/4	100

Nicropress Tools

The finest and most accurate hand closing tools for Nicropress Sleeves.



Part No.	Type:	Length: cm/in		Use With:	Size
C960N	63V XPM	51	20	B544N-B546N	1/8 - 5/32, 3/16
C962N	64CgMP	51	20	B544N-B: 46N	1/16, 3/32, 1/8, 5/32

Copper Sleeves

- Plain copper sleeves.
- Manufactured to metric sizes.
- Closing tools available against special order.

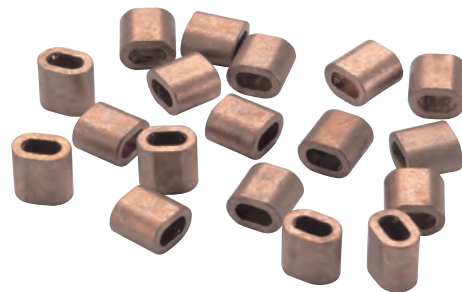

Part No.	Wire Size: mm/in		Pack Qty
B540	2.0	1/16	100
B541	2.5	3/32	100
B542	3.0	1/8	100
B543	3.5	7/64	100
B544	4.0	5/32	100
B546	5.0	13/64	100
B547	6.0	1/4	100

Inox Pressed Ring System

Inox Pressed Rings

The Bainbridge International Inox Ring System has been in constant worldwide use by top sailmakers for many years because it offers high strength and corrosion resistance with ease of setting and a range of attachments to simplify and enhance sail attachment points.

- Manufactured from type 316 stainless steel, and injection molded nylon.
- Liners and pins are passivated to reduce risk of staining.
- Liners are seamless for maximum strength.
- Range of colours to permit the use of house colours and sail identification.
- Finely pointed pins penetrate between the sailcloth fibres and do not cut the fabric.
- Nylon ring gives chafe-free contact with sailcloth.
- When set, the pins are locked through the sailcloth and into the opposite face of the ring providing DOUBLE SHEAR strength.
- Excellent internal profile for attachment of sheets. Often used as a Cunningham.

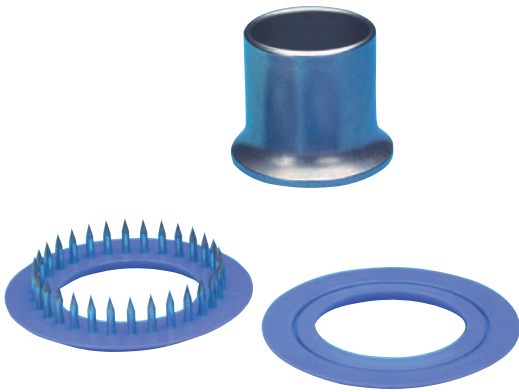

Part No.	Set Hole Dia: mm/in		Colour	Pack Qty
D208B	10	3/8	Black	20
D208R	10	3/8	Red	20
D208G	10	3/8	Green	20
D208N	10	3/8	Blue	20
D208W	10	3/8	White	20
D207B	12	1/2	Black	20
D207R	12	1/2	Red	20
D207G	12	1/2	Green	20
D207N	12	1/2	Blue	20
D207W	12	1/2	White	20
D209B	15	5/8	Black	20
D209R	15	5/8	Red	20
D209G	15	5/8	Green	20
D209N	15	5/8	Blue	20
D209W	15	5/8	White	20
D210B	20	7/8	Black	20
D210R	20	7/8	Red	20
D210N	20	7/8	Blue	20
D210W	20	7/8	White	20
D211B	25	1	Black	10
D211R	25	1	Red	10
D211G	25	1	Green	10
D211N	25	1	Blue	10
D211W	25	1	White	10
D212B	30	1 1/4	Black	10
D212R	30	1 1/4	Red	10
D212N	30	1 1/4	Blue	10
D212G	30	1 1/4	Green	10

Part No.	Set Hole Dia: mm/in		Colour	Pack Qty
D213B	35	1 3/8	Black	10
D213R	35	1 3/8	Red	10
D213N	35	1 3/8	Blue	10
D213G	35	1 3/8	Green	10
D214B	40	1 5/8	Black	1
D214R	40	1 5/8	Red	1
D214N	40	1 5/8	Blue	1
D214G	40	1 5/8	Green	1

Inox Rings for Hand Closing

- Nickel Plated Brass Liners replace the regular stainless steel liners to permit closing without the use of a hydraulic press.
- These rings can be closed by using the tools shown opposite.

Part No.	Set Hole Dia: mm/in		Colour	Pack Qty
D207BH	12	1/2	Black	20
D207RH	12	1/2	Red	20
D207GH	12	1/2	Green	20
D207NH	12	1/2	Blue	20
D207WH	12	1/2	White	20
D209BH	15	5/8	Black	20
D209GH	15	5/8	Red	20
D209NH	15	5/8	Green	20
D209WH	15	5/8	White	20

Setting Inox Rings

- The design build-up will allow the maximum strength of the ring to be developed. In lighter sails, it is not imperative to use this design thickness.
- Inox Rings should always be set on the correct tools.
- Damage to the dies can be caused by excessive pressure. Always start with the pressure valve unloaded and build up from zero to the desired pressure.
- Tools should be polished if wear becomes evident. Light lubrication of the working faces is recommended.
- Rings must be closed with the pinned section and liner facing up in the base of the closing tool.
- Surrounding cloth should be supported while ring is being closed.



Completely and correctly closed Inox Ring

Part No.	Cloth Build-Up Thickness: mm	Hole Punch Size: mm/in	Hole Punch Part No.	Closing Tool Part No.	Suggested Closing Force: Tonnes	Hole Size When Set: mm/in
D208	0.7	12.7 1/2	C108	C408	6 - 9	10 3/8
D207	0.6	15.9 5/8	C110	C407	6 - 8	12 1/2
D209	1.6	19.0 3/4	C112	C409	9 - 11	15 5/8
D210	2.1	22.2 7/8	C114	C410	11 - 15	20 7/8
D211	2.5	28.6 1 1/8	C117	C411	13 - 16	25 1
D212	2.8	34.9 1 3/8	C119	C412	18 - 20	30 1 1/4
D213	3.1	38.1 1 1/2	C120	C413	19 - 23	35 1 3/8
D214	3.3	44.5 1 3/4	C122	C414	20 - 25	40 1 5/8

Inox Pressed Ring System

Closing Tools for Inox Rings

These tools are suitable for most presses. All except C408 can be used with Enerpac-Nautilus pull down presses by pushing out the centre post.



Part No.	Use Tool For
C408	D208
C407	D207
C409	D209
C410	D210
C411	D211
C412	D212
C413	D213
C414	D214

Presses for Setting Rings

Ringmaster Presses were developed by Bainbridge International especially for the sailmaker. They offer clear access to the working area with all hydraulics removed from risk of contact with the sailcloth: they are simple to use and can be easily moved. A hand operated version is available for use in temporary lofts.

- C-Frame design gives maximum accessibility.
- All hydraulics are positioned away from the working area to avoid the risk of contaminating the sail.
- Pump unit on flexible lead to facilitate bench use if required (C996).
- Fitted with lifting handles and rollers for ease of handling on the loft floor or in a mobile repair loft.

Part No.	Closing Force	Clearance: mm/in	Throat Depth: mm/in	Power
C995	30 Tonnes	120 4 3/4	130 5 1/4	Manual
C996	30 Tonnes	120 4 3/4	130 5 1/4	240V 50HZ

Note: Prices for presses will be quoted ex-works at the time of inquiry. Packing is extra. Exact specifications may vary.

Teflon® Lubricating Spray

- Use for lubricating dies, closing tools and generally around the loft.
- Synthetic lubricant that out-performs and outlasts petroleum based lubricants.
- Reduces friction and wear.
- Prevents rust and corrosion.
- Contains no CFC's or chlorinated solvents.



Part No.	Liquid Measure
M005	312ml/11 Fl oz

Outhaul Slug Slide Attachments

- Type 316 stainless steel strap provides ultra-high strength attachment to Inox rings.
- Minimum offset permits ring to be very low in the sail.
- Low friction injection molded slide with encapsulated bail.
- 'C' products feature reduced bail thickness of 2mm for use in modern dinghy booms with very narrow groove opening.
- Sold in packs of 25.



Part No.	Set Hole Dia: mm/in	To Be Used With
B2075	7.9 5/16	D207
B2075C	7.9 5/16	D207
B2076	9.3 3/8	D207
B2076C	9.3 3/8	D207
B2095	7.9 5/16	D209
B2095C	7.9 5/16	D209
B2096	9.3 3/8	D209
B2106	9.3 3/8	D210
B2108	12.0 1/2	D210
B2116	9.3 3/8	D211
B2118	12.0 1/2	D211

English Grommets

Self-Piercing Grommets/Washers

- Grommets and washers are sold as sets, and are available in brass, nickel plated brass or stainless steel.
- Manufactured from brass with a lacquer finish.
- Self-piercing grommets and washers are sold in full boxes only. 100 sets per box.

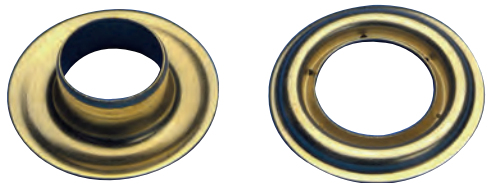

Part No.	Material	Size/Mfg #	Inside Diameter: mm/in
D101B	Brass	1 230	8 $\frac{5}{16}$
D102B	Brass	2 250	10 $\frac{3}{8}$

English Rolled Rim Grommets- Brass Finish

Low cost, roll-rim, spur-toothed grommets suitable for a wide range of applications in sailmaking and cover work.

- Available only in full packs.



Part No.	Set Hole Dia: mm/in	Size	Pack Qty
D002B	6.4 1/4	00	1000
D003B	8.4 21/64	0	1000
D004B	9.5 3/8	1	1000
D005B	11.9 15/32	2	1000
D006B	12.7 1/2	3	1000
D007B	14.7 37/64	4	1000
D008B	17.0 11/16	5	1000

English Spur-Toothed Grommets- Nickel Plated Finish

Low cost, roll-rim, spur-toothed grommets suitable for a wide range of applications in sailmaking and cover work.

- Available only in full packs.
- Available in pack quantities to suit smaller/larger consumers.



Part No. Small Pack	Part No. Bulk Pack	Set Hole Dia: mm/in	Size	Pack Qty Small/Bulk
D001NX	D001N	5.1 13/61	000	200 1000
D002NX	D002N	6.4 1/4	00	200 1000
D003NX	D003N	8.4 21/64	0	200 1000
D004NX	D004N	9.5 3/8	1	200 1000
D005NX	D005N	11.9 15/32	2	200 1000
D006NX	D006N	12.7 1/2	3	200 1000
D007NX	D007N	14.7 37/64	4	200 1000
D008NX	D008N	17.0 11/16	5	200 1000
D009NX	D009N	19.8 25/32	6	200 1000

Closing Tools for English Grommets

- Tools for English Grommets cannot be used with Stimpson Grommets.



Cross section when set

Part No.	Size
C301	000
C302	00
C303	0
C304	1
C305	2
C306	3
C307	4
C308	5
C309	6



Hole Punch and Closing Tool Data for English Grommets

Part No.	Size	Hole Punch Dia: mm/in	Hole Punch	Closing Tool
D001B/N	000	4.8 $\frac{3}{16}$	C103	C301
D002B/N	00	7.9 $\frac{5}{16}$	C105	C302
D003B/N	0	9.5 $\frac{3}{8}$	C106	C303
D004B/N	1	11.1 $\frac{7}{16}$	C107	C304
D005B/N	2	12.7 $\frac{1}{2}$	C108	C305
D006B/N	3	14.3 $\frac{9}{16}$	C109	C306
D007B/N	4	15.9 $\frac{5}{8}$	C110	C307
D008B/N	5	17.5 $\frac{11}{16}$	C111	C308
D009B/N	6	22.2 $\frac{7}{8}$	C114	C309

Self-Piercing Grommets/Washers Stainless Steel

- Manufactured from stainless steel, which is sharper and stronger than either of the afore mentioned styles.
- Self-piercing grommets and washers are sold in full boxes only. 100 sets per box.



Part No.	Material	Size/Mfg #	Inside Diameter: mm/in
D112SS	Stainless Steel	2 250	10 $\frac{3}{8}$

Stimpson Grommets

Self-Piercing Grommets/Washers - Nickel

- Manufactured from nickel plated brass with sharpened ground edge for penetrating into more difficult materials.
- Self-piercing grommets and washers are sold in full boxes only. 100 sets per box.



Part No.	Material	Size/Mfg #	Inside Diameter: mm/in
D111N	Nickel Plated Brass	1 230	8 $\frac{5}{16}$
D112N	Nickel Plated Brass	2 250	10 $\frac{3}{8}$
D113N	Nickel Plated Brass	3 280	11 $\frac{7}{16}$

Stimpson Spur-Toothed Grommets - Brass Finish

The higher strength of these spur-toothed grommets derives from their thicker metal gauge, and flange closing.

- Available only in full packs of 144.



Part No.	Size	Set Hole Diameter: mm/in	Pack Qty
D003BS	0	6.4 $\frac{1}{4}$	144
D004BS	1	9.5 $\frac{3}{8}$	144
D005BS	2	10.3 $\frac{13}{32}$	144
D006BS	3	11.1 $\frac{7}{16}$	144
D007BS	4	14.2 $\frac{9}{16}$	144
D008BS	5	15.0 $\frac{19}{32}$	144

Stimpson Spur-Toothed Grommets - Nickel Plated Finish

The higher strength of these spur-toothed grommets derives from their thicker metal gauge, and flange closing.

- Available only in full packs of 144.



Part No.	Size	Set Hole Diameter: mm/in	Pack Qty
D003NS	0	6.4 $\frac{1}{4}$	144
D004NS	1	9.5 $\frac{3}{8}$	144
D005NS	2	10.3 $\frac{13}{32}$	144
D006NS	3	11.1 $\frac{7}{16}$	144
D007NS	4	14.2 $\frac{9}{16}$	144
D008NS	5	15.0 $\frac{19}{32}$	144
D009NS	6	17.4 $\frac{11}{16}$	144

Stimpson Plain Rim Grommets with Plain Washers

- Available only in full packs of 144.



Part No.	Material	Size Reference	Inside Diameter: mm/in
D602B	Solid Brass	00	4 $\frac{5}{32}$
D603B	Solid Brass	0	6 $\frac{1}{4}$
D605B	Solid Brass	2	10 $\frac{3}{8}$
D604N	Solid Brass/Nickel Finish	1	8 $\frac{5}{16}$
D605N	Solid Brass/Nickel Finish	2	10 $\frac{3}{8}$
D606N	Solid Brass/Nickel Finish	3	11 $\frac{7}{16}$

Closing Tools for Stimpson Grommets

- Stimpson Grommets cannot be used with English Grommet tools.
- Stimpson tools are machined steel case hardened dies.
- Low-cost tools are drop forged steel dies.

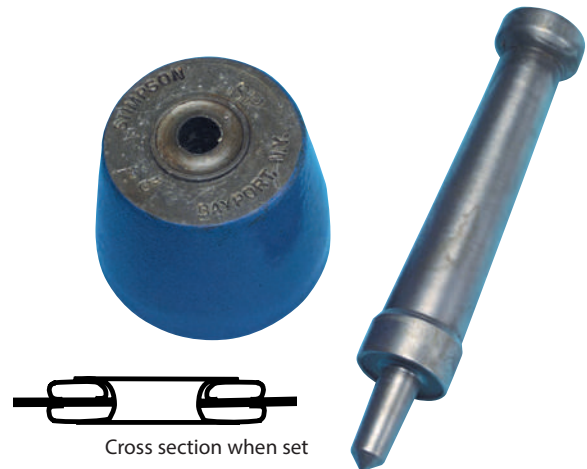

Cross section when set

Stimpson Part No.	Low Cost Tool Part No.	Size
C303S	C303C	0
C304S	C304C	1
C305S	C305C	2
C306S	C306C	3
C307S	C307C	4
C308S		5
C309S		6

Hole Punch and Closing Tool Data for Stimpson Grommets

Part No.	Size	Hole Punch Diameter: mm/in	Hole Punch	Closing Tool
D003BS/NS	0	9.5 $\frac{3}{8}$	C152	C303S
D004BS/NS	1	11.1 $\frac{7}{16}$	C153	C304S
D005BS/NS	2	12.7 $\frac{1}{2}$	C154	C305S
D006BS/NS	3	14.3 $\frac{9}{16}$	C155	C306S
D007BS/NS	4	15.9 $\frac{5}{8}$	C156	C307S
D008BS/NS	5	17.5 $\frac{11}{16}$	C157	C308S
D009BS/NS	6	22.2 $\frac{7}{8}$	C158	C309S

Stainless Steel Rings

Stainless Steel Welded Hardware

All Bainbridge International welded stainless steel fittings are manufactured from type 316 stainless steel, which is chemically cleaned and passivated after welding to reduce the risk of staining. TIG welding maximises strength.



Round Rings

- High grade stainless steel.
- TIG welded.
- Small diameter rings with the same size bar diameter will deform at a higher load although both will have similar tensile strength.
- B214, B227, B118, B117, B228, B119, B 219, B229, B121, B120 sold in packs of 10.
- B220, B221, B225, B223 sold individually.



Part No.	Inside Diameter: mm/in		Bar Diameter: mm/in		Weight: gm/oz		Safe Working Load: kg/lb	
B214	25	1	4.8	$\frac{3}{16}$	14	0.5	300	700
B227	25	1	6.3	$\frac{1}{4}$	21	0.7	800	1800
B118	32	$1\frac{1}{4}$	4.8	$\frac{3}{16}$	16	0.6	150	350
B117	32	$1\frac{1}{4}$	6.3	$\frac{1}{4}$	28	1.0	600	1300
B228	32	$1\frac{1}{4}$	7.9	$\frac{5}{16}$	49	1.7	1000	2200
B119	38	$1\frac{1}{2}$	6.3	$\frac{1}{4}$	35	1.2	400	900
B219	38	$1\frac{1}{2}$	7.9	$\frac{5}{16}$	57	2.0	750	1600
B229	38	$1\frac{1}{2}$	9.3	$\frac{3}{8}$	85	3.0	1300	2800
B121	44	$1\frac{3}{4}$	7.9	$\frac{5}{16}$	64	2.3	900	2000
B120	51	2	6.3	$\frac{1}{4}$	42	1.5	350	800
B220	51	2	7.9	$\frac{5}{16}$	71	2.5	550	1200
B221	51	2	9.3	$\frac{3}{8}$	106	3.7	1000	2200
B225	51	2	11.1	$\frac{7}{16}$	149	5.3	2300	5000
B223	64	$2\frac{1}{2}$	9.3	$\frac{3}{8}$	127	4.5	750	1600

"D" Rings

- High grade stainless steel.
- TIG welded.
- Sold in packs of 10.



Part No.	Inside Width: mm/in		Bar Diameter: mm/in		Weight: gm/oz		Safe Working Load: kg/lb	
B170	25	1	4.8	$\frac{3}{16}$	14	0.5	300	700
B171	31	$1\frac{1}{4}$	4.8	$\frac{3}{16}$	18	0.6	300	700
B172	38	$1\frac{1}{2}$	4.8	$\frac{3}{16}$	21	0.7	300	700
B173	51	2	4.8	$\frac{3}{16}$	23	0.8	150	350
B174	51	2	6.3	$\frac{1}{4}$	42	1.5	500	1100

Triangles - With & Without Bar

- High grade stainless steel.
- TIG welded.
- Reinforcing bar reduces potential distortion under high load and inhibits D-ring from rotating.



B127



B127B

Part No.	Inside Width: mm/in		Bar Diameter: mm/in		Weight: gm/oz		Safe Working Load: kg/lb	
B127	51	2	6.3	$\frac{1}{4}$	49	1.7	500	1100
B127B	51	2	6.3	$\frac{1}{4}$	57	2.0	1000	2200

Maxi Rings



- High grade stainless steel.
- TIG welded.
- Reinforcing bar reduces potential distortion under high load.



B229/5/6/18B



B229/5/6/18BB

Part No.	Inside Width: mm/in		Bar Diameter: mm/in		Weight: gm/oz		Safe Working Load: kg/lb	
B229B	38	$1\frac{1}{2}$	9.3	$\frac{3}{8}$	106	3.7	2600	5700
B225B	51	2	11.1	$\frac{7}{16}$	191	6.7	4000	8800
B226B	64	$2\frac{1}{2}$	12.7	$\frac{1}{2}$	298	10.5	4500	9900
B218B	76	3	15.8	$\frac{5}{8}$	568	20.1	10000	2200
 B229BB*	38	$1\frac{1}{2}$	9.3	$\frac{3}{8}$	106	3.7	2600	5700
 B225BB*	51	2	11.1	$\frac{7}{16}$	191	6.7	4000	8800
 B226BB*	64	$2\frac{1}{2}$	12.7	$\frac{1}{2}$	298	10.5	4500	9900
 B218BB*	76	3	15.8	$\frac{5}{8}$	568	20.1	10000	2200

*manufactured with an additional bar for even more strength.

Clew Pieces

- High grade stainless steel.
- TIG welded.
- Distinctive pattern incorporates high strength with slots to secure webbing and prevents ring from rotating.



Part No.	Inside Width: mm/in		Bar Diameter: mm/in		Weight: gm/oz		Safe Working Load: kg/lb	
B123	51	2	7.9	$\frac{5}{16}$	99	3.5	850	1900
B124	64	$2\frac{1}{2}$	9.3	$\frac{3}{8}$	156	5.5	1000	2200
B125	76	3	11.1	$\frac{7}{16}$	276	9.8	2800	6200
B126	96	$3\frac{3}{4}$	12.7	$\frac{1}{2}$	446	15.8	3800	8400
B122		$4\frac{1}{4}$		$\frac{5}{8}$				

Stainless Steel, Brass & Nickel Rings

Clew Piece with Bar/Diamond D Rings

- The unique design enables webbing to be aligned with the stress lines of the sail.
- High grade stainless steel with TIG welds to yield maximum strength.
- Super strong design.

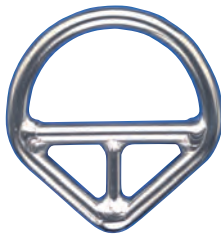

Part No.	Inside Width: mm/in		Bar Diameter: mm/in		Safe Working Load: kg/lb	
B165	75	3	11	7/16	3000	6600

Cast 17-4 Stainless Steel Sail Rings

Unique computer design combined with high performance cast 17-4 stainless steel construction makes these sail rings lighter and stronger than comparable conventional welded rings. Easily webbed to the sail they are ideal for head and clew applications in mainsails, headsails and spinnakers.

- Lighter and stronger than conventional equivalent welded rings.
- Cast construction eliminates weld weak point.
- Made from 17-4 stainless steel, higher SWL than type 316.
- Elliptical cross-section and strengthening bar increase stiffness.
- Easy to web to sail.
- Can accommodate multiple sheets during sail or sheet point changes.



Part No.	Length: mm/in	Width: mm/in	Bar Dia: mm/in	Weight: gm/oz	Safe Working Load: kg/lb	
B248	74 2 15/16	58 2 5/16	9.3 x 6.4 3/8 x 1/4	73 2.6	2000	4400
B250	92 3 5/8	72 2 7/8	10.5 x 7.2 7/16 x 9/16	126 4.4	3000	6600

Stainless Steel O Rings - Welded

- Economy rings designed for low load applications.



Part No.	Inside Diameter: mm/in	Bar Diameter: mm/in	Pack Qty
B204	25 1	3 1/8	10

Economy Welded Hardware

Bainbridge International economy welded rings are intended for low load applications. They are NOT suitable as sail rings, or for use on safety harnesses, lifelines or jackstays



Nickel Plated Steel O Rings - Welded

- Economy rings designed for low load applications.
- Use on bags, soft sided luggage.



Part No.	Inside Diameter: mm/in	Bar Diameter: mm/in	Pack Qty
B191	25 1	5 3/16	10

Nickel Plated Steel D Rings - Welded

- Economy rings designed for low load applications.



Part No.	Inside Diameter: mm/in	Bar Diameter: mm/in	Pack Qty
B196	25 1	4 5/32	10
B197	38 1 1/2	5 3/16	10

Brass Rings

- Manufactured from heavy solid brass.



Part No.	Inside Width: mm/in	Thickness: mm/in	Use With Liner No.	Pack Qty
Q143	12 1/2	3 1/8	Q243	3 10
Q144	15 5/8	4 5/32	Q244	4 10
Q145	19 3/4	5 3/16	Q245	5 10
Q146	22 7/8	5 3/16	Q246	6 10
Q147	25 1	5 3/16	Q247	7 10
Q148	28 1 1/8	5 3/16	Q248	8 10
Q149	31 1 1/4	6 1/4	Q249	9 10
Q150	38 1 1/2	8 5/16	Q250	10 10

Rings & Snap Hooks

Stainless Steel D Rings - Welded

- Economy rings designed for low load applications.



Part No.	Inside Diameter: mm/in		Bar Diameter: mm/in		Pack Qty
B169	25	1	5	$\frac{3}{16}$	10
B174	51	2	6.3	$\frac{1}{4}$	10



Economy welded rings are suitable for use on covers, awnings, bags and straps. They are NOT suitable as sail rings, or for use on safety harnesses, lifelines or jackstays.

Snap Hooks - Carabiner

- Carabiner snaps ("Fireman hook") with spring loaded jaw, in economy steel for use on banners, key rings, buckets, etc.
- Warning: Carabiner Snap Hooks should not be used for high load applications such as emergency safety equipment.

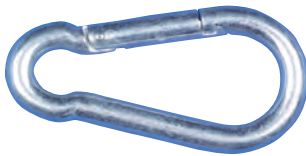

Part No.	Material	Dim. (a): mm/in		Dim. (b): mm/in		Pack Qty
B651	Economy Steel	60	$2\frac{3}{8}$	6	$\frac{1}{4}$	25
B652	Economy Steel	80	$3\frac{1}{4}$	8	$\frac{5}{16}$	25

Snap Hooks

- Brass snap hooks are an all purpose hook used in many applications where loads are relatively low.
- Stainless steel offers the same efficient and easy to use shape, but has much greater safe working loads.



Part No.	Material	Type	Length: mm/in	Inside Eye Dia: mm/in		Pack Qty
B610	Brass	0	53 $2\frac{1}{8}$	10	$\frac{3}{8}$	10
B611	Brass	1	72 $2\frac{7}{8}$	15	$\frac{5}{8}$	10
B611N	Brass/Nickel Plate	1	72 $2\frac{7}{8}$	15	$\frac{5}{8}$	10
B612	Brass	2	81 $3\frac{1}{4}$	20	$\frac{3}{4}$	10
B610S	Stainless Steel	0	53 $2\frac{1}{8}$	10	$\frac{3}{8}$	10
B611S	Stainless Steel	1	72 $2\frac{7}{8}$	15	$\frac{5}{8}$	10
B612S	Stainless Steel	2	81 $3\frac{1}{4}$	20	$\frac{3}{4}$	10

Snap Hook - Rectangle Eye

- Stainless steel snap hooks are all purpose hooks used in many applications where loads are relatively low.
- Ideal for use with 25.4mm/1 inch webbing.



Part No.	Material	Length: mm/in	Inside Eye: mm/in		Pack Qty
B617S	Stainless Steel	50 2	25.4	1	10

Swivel Snap Hooks

- Bronze snap hooks are an all purpose hook used in many applications where loads are relatively low.
- Swivel prevents halyard from twisting.



Part No.	Material	Type	Length: mm/in	Inside Eye Diameter: mm/in		Pack Qty
B611SW	Bronze	1	81 $3\frac{1}{4}$	15	$\frac{5}{8}$	10

Snap Hooks - Swivel Eye

- Snap hooks are an all purpose hook used in many applications where loads are relatively low.



Part No.	Material	Length: mm/in	Inside Eye: mm/in		Pack Qty
B615	Bronze	75 3	10	$\frac{3}{8}$	10

Webbing Attachments

Snap Hook - Swivel Trigger



Part No.	Material	Length: mm/in	Inside Eye: mm/in	Pack Qty
B632	Bronze	64 2 1/2	10 3/8	10

Snap Hooks - Swivel Eye for Webbing

- Rectangular webbing eye.
- Snap hooks are an all purpose hook used in many applications where loads are relatively low.

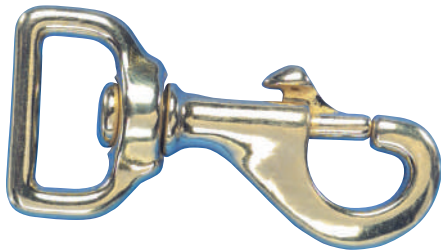

Part No.	Material	Length: mm/in	Inside Eye: mm/in	Pack Qty
B637	Bronze	75 3	25 1	10

Cam Buckles



A079WT



A079BK



B087

Part No.	For Webbing: mm/in	Material	Pack Qty
A078WT	19 3/4	White Nylon	10
A079WT	25 1	White Nylon	10
A079BK	25 1	Black Nylon	10
A072BK	50 2	Black Nylon	10
B087	25 1	Stainless Steel	1

Ladderlock Buckles

- A076HD & A77HD are over three times the strength of standard ladderlock.



A076



A076HD



Part No.	For Webbing: mm/in	Material	Pack Qty
A073	40 1 1/2	Black Nylon	10
A074	15 5/8	Black Nylon	10
A075	19 3/4	Black Nylon	10
A076	25 1	Black Nylon	10
A076HD	25 1	Heavy Duty Nylon	10
A077HD	50 2	Heavy Duty Nylon	10

Snap Buckles

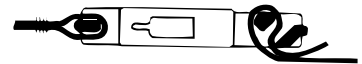

A089BK

Part No.	For Webbing: mm/in	Material	Pack Qty
A087	15 5/8	Black Nylon	10
A088	19 3/4	Black Nylon	10
A089	25 1	Black Nylon	10
A085	50 2	Black Nylon	10
A089WT	25 1	White Nylon	10

Adjuster Buckles

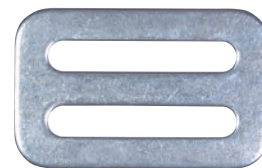

G210S

Part No.	For Webbing: mm/in	Material	Pack Qty
G210S	25 1	Stainless Steel	10

Webbing Attachments

Sliding Bar Buckles



Part No.	For Webbing: mm/in		Material	Pack Qty
G221	25	1	Stainless Steel/Nylon	Each
G222	50	2	Stainless Steel/Nylon	Each
G221S	25	1	Stainless Steel	Each
G222S	50	2	Stainless Steel	Each
G223	40	1 9/16	Stainless Steel/Nylon	Each



Stainless Quick Release Buckle

- Stainless steel construction.
- Compatible with most styles of 25mm /1" webbing.
- Features a 'quick release' fastener.
- Applications: Awning, boat covers, adjustable tie-downs etc.



Part No.	Inside Eye: mm/in		Material	Pack Qty
G215S	25	1	Stainless Steel	Each

Eye Straps



Part No.	Description	Pack Qty
G203S	Stamped Stainless Steel	Each
G204N	Cast Nickel Plated Brass	Each

Snap Hook - Webbing

- G200S has rectangular eye for webbing.

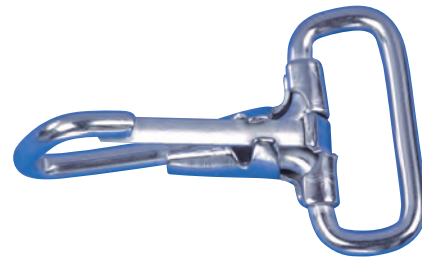

Part No.	Material	Length: mm/in		Inside Eye: mm/in		Pack Qty
G200S	Stainless Steel	50	2	25	1	Each

Swivel Webbing Buckle with Socket

- Swivel pin allows installer to compensate for angles.
- Turn buckle 180° for easy removal from socket.
- Type 316 stainless steel.

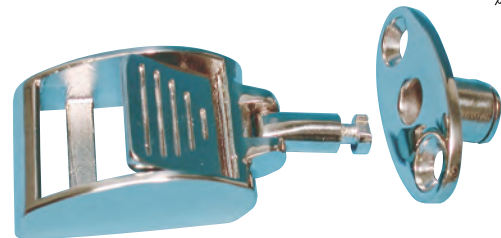

Part No.	Description	Pack Qty
G742S	Swivel Web Buckle	1

Adjustable Tie-Down Hook

- Heavy duty tie-down hook with adjustable ladderlock for 1 inch webbing.
- Excellent for canoes, automobile rooftop carriers, cargo straps.
- Overall hook length: 4 3/4 inches.

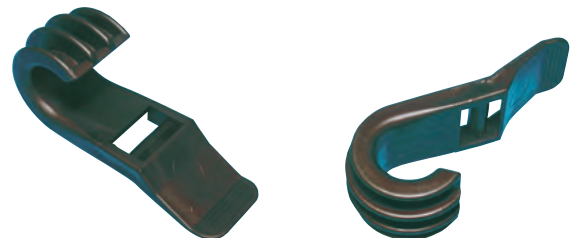

Part No.	For Webbing: mm/in		Description	Colour	Pack Qty
A120BK	25	1	Nylon	Black	Each

Webbing Attachments

Tri Glide - Plastic



Part No.	For Webbing: mm/in		Material	Pack Qty
A122BK	25	1	Black Plastic	Each
A142BK	38	1 1/2	Black Plastic	Each
A125BK	50	2	Black Plastic	Each

Loop Loc

- Ideal for holding straps or webbing where no adjustment is needed.



Part No.	For Webbing: mm/in	Material	Color	Pack Qty
A124BK	25 1	Acetal Plastic	Black	Each

Snap Hooks - Acetal Plastic

- Light weight and durable component system for detachable straps.

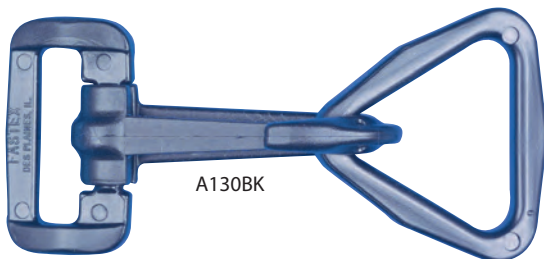

A130BK

A131BK
A141BK

A134BK
A144BK



A135BK

Part No.	For Webbing: mm/in	Description	Color	Pack Qty
A130BK	-	Hook	Black	Each
A131BK	25 1	1 Inch Retainer	Black	Each
A134BK	25 1	1 Inch Tri-Ring	Black	Each
A135BK	25 1	1" Ladderlock Retainer	Black	Each
A141BK	38 1 1/2	1 1/2 Inch Retainer	Black	Each

Webbing Bridges



A095BK



A096WT

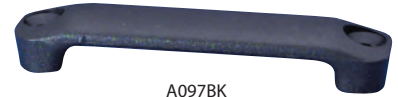

A097BK

Part No.	For Webbing: mm/in		Material	Pack Qty
A095WT	25 - 30	1 - 1 1/4	White nylon	Each
A095BK	25 - 30	1 - 1 1/4	Black nylon	Each
A096WT	40	1 1/2	White nylon	Each
A096BK	40	1 1/2	Black nylon	Each
A097WT	50	2	White nylon	Each
A097BK	50	2	Black nylon	Each

Shock Cord to Webbing Connector

- Connector to link 6mm shock cord to 38mm webbing.
- Black Delrin.



Part No.	Cord Diameter: mm/in	Length: mm/in	Pack Qty
A145BK	6 1/4	38 1	Each

Centre Release Buckle

- 3/4" centre release buckle.



Part No.	For Webbing: mm/in	Material	Color	Pack Qty
A159BK	19 1 3/4	Acetal Plastic	Black	Each

Coloured Polypropylene Webbing

Coloured Polypropylene Webbing

- Widths available: 19mm, 25mm, 40mm and 50mm.
- Polypropylene webbing is solution dyed.
- Available only on full 50m reels.



BK
Black

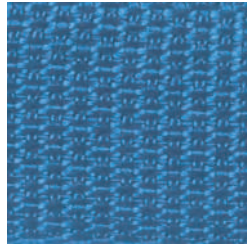

BU
Blue

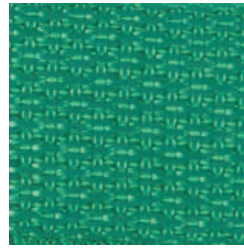

GR
Green

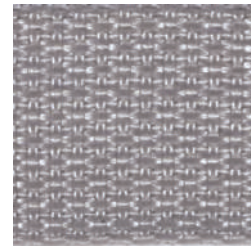

GY
Grey

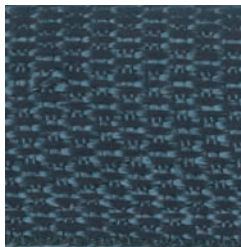

NB
Navy Blue

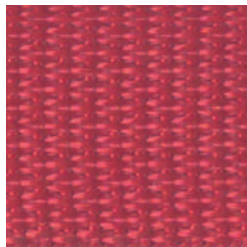

RD
Red



WT
White



YE
Yellow

Note: Information correct at time of print. Other colours available against special order. Colour representation from 4-color process and for reference purposes only. Please inquire for colour sample of actual fabric.

19mm Coloured Polypropylene Webbing

- Available only on full reels.

Part No.	Width: mm/in		Reel Length: m/yd		Breaking Strength: kg/lb		Colour
E225BK	19	0.75	50	55	225	496	Black
E225BU	19	0.75	50	55	225	496	Blue
E225GY	19	0.75	50	55	225	496	Grey
E225NB	19	0.75	50	55	225	496	Navy
E225WT	19	0.75	50	55	225	496	White
E225YE	19	0.75	50	55	225	496	Yellow

25mm Coloured Polypropylene Webbing

- Available only on full reels.

Part No.	Width: mm/in		Reel Length: m/yd		Breaking Strength: kg/lb		Colour
E226BK	25	1	50	55	275	606	Black
E226BU	25	1	50	55	275	606	Blue
E226GY	25	1	50	55	275	606	Grey
E226NB	25	1	50	55	275	606	Navy
E226RD	25	1	50	55	275	606	Red
E226WT	25	1	50	55	275	606	White

40mm Standard Polypropylene Webbing

- Available only on full reels.

Part No.	Width: mm/in		Reel Length: m/yd		Breaking Strength: kg/lb		Colour
E227BK	40	1.5	50	55	425	937	Black
E227BU	40	1.5	50	55	425	937	Blue
E227GR	40	1.5	50	55	425	937	Green
E225GY	40	1.5	50	55	425	937	Grey
E227NB	40	1.5	50	55	425	937	Navy
E227RD	40	1.5	50	55	425	937	Red
E227WT	40	1.5	50	55	425	937	White
E227BK38	38	1.5	50	55	425	937	Black

50mm Coloured Polypropylene Webbing

- Available only on full reels.

Part No.	Width: mm/in		Reel Length: m/yd		Breaking Strength: kg/lb		Colour
E228BK	50	2	50	55	525	1157	Black
E228NB	50	2	50	55	525	1157	Navy
E228WT	50	2	50	55	525	1157	White

Standard Weight - Polyester

- Available only on full reels.

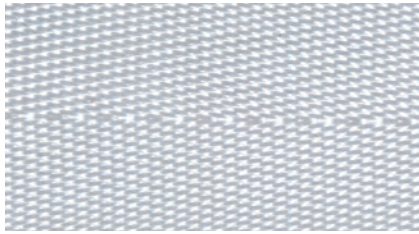

Part No.	Width: mm/in	Reel Length: m/yd	Breaking Strength: kg/lb
E110	12 1/2	50 55	300 660
E111	19 3/4	50 55	500 1100
E112	25 1	50 55	600 1300
E117	30 1 1/4	50 55	850 1850

Heavy Weight - Polyester

- Available only on full reels.



Part No.	Width: mm/in	Reel Length: m/yd	Breaking Strength: kg/lb
E109	12 1/2	25 27	400 880
N E113	25 1	25 27	750 1650
E114	30 1 1/4	25 27	850 1850
E115	40 1 1/2	25 27	1000 2200
E116	50 2	25 27	1200 2600
E108	63 2 1/2	25 27	1400 3100
N E127	20 3/4	25 27	500 1102

Extra Heavy Weight - Polyester

- Available only on full reels.

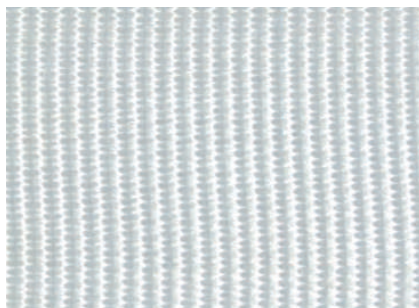

Part No.	Width: mm/in	Reel Length: m/yd	Breaking Strength: kg/lb
E118	25 1	25 27	1500 3300
E119	30 1 1/4	25 27	1800 3900
E120	40 1 1/2	25 27	2400 5300
E121	51 2	25 27	3100 6800

Super Heavy Weight - Polyester

- Available only on full reels.

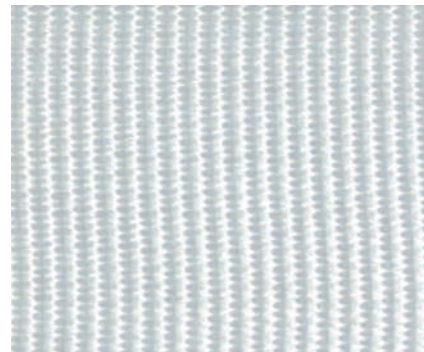

Part No.	Width: mm/in	Reel Length: m/yd	Breaking Strength: kg/lb
E129	46 1 3/4	25 27	2800 6200

Super Heavy Weight - Tubular

- Available only on full reels.
- All products are nylon except E124 Dacron.

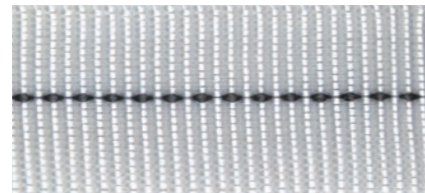

E124

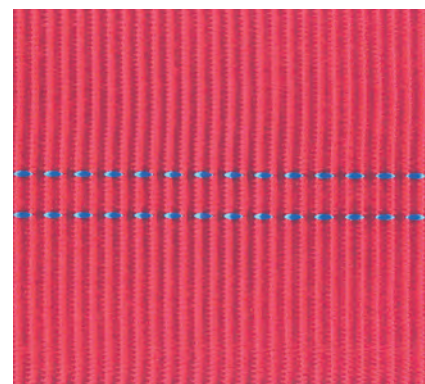

E120NRD

Part No.	Width: mm/in	Reel Length: m/yd	Breaking Strength: kg/lb	Colour
E122	12 1/2	183 200	700 1550	White
E123	19 3/4	183 200	1450 3200	White
E124	25 1	46 50	1700 3700	White
E124NBU	25 1	46 50	1800 4000	Blue
E124NBK	25 1	91 100	1800 4000	Black
E120NRD	50 2	46 50	3600 8000	Red

Note: Information correct at time of print. Colour representation from 4-colour process and for reference purposes only. Please enquire for colour sample of actual fabric.

Webbing

Soft Spun Dacron® Tubular

- Soft hand tubular construction.
- Excellent for sail ties.
- Available only on full reels.



Part No.	Width: mm/in		Reel Length: m/yd		Breaking Strength: kg/lb		Colour
E101	29	1 1/8	46	50	907	2000	White

Kevlar® Reinforced Polyester

- Cover protects Kevlar® from UV degradation and reduces flexing and chafe.
- Available only on full reels.



Part No.	Width: mm/in		Reel Length: m/yd		Breaking Strength: kg/lb	
E131	25	1	25	27	1900	4100
E133	35	1 1/4	25	27	2600	5700

Spectra®

- Lighter than Kevlar and does not absorb water.
- Excellent UV resistance and flex characteristics.
- Spectra is a very strong and low stretch fibre.
- Available only on full reels.

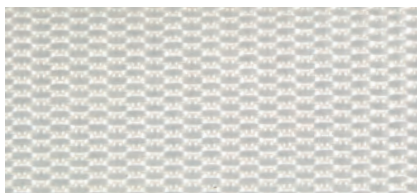

Part No.	Width: mm/in		Reel Length: m/yd		Breaking Strength: kg/lb	
E135SP	25	1	23	25	1800	4000
E139SP	45	1 3/4	23	25	3100	7000

Seat Belt Style Polyester

- Rugged polyester webbing, five panel construction, recommended for hiking straps, bag handles, nose piece for kites, reinforcement, tie down, trampolines, etc.
- Excellent UV resistance.
- Available only on full reels.



Part No.	Width: mm/in		Reel Length: m/yd		Breaking Strength: kg/lb		Colour
E115BK	28	1 1/2	137	150	1134	2494	Black
E121BK	50	2	91	100	1134	2494	Black

Toe Strap Webbing

- Rugged heavy duty polyester webbing
- Excellent UV resistance.
- Can be used as toe strap, jackstay or seatbelt webbing.
- Available in black, blue and red.



Part No.	Roll Width: mm/in		Reel Length: m/yd		Colour
MBBA000	50	2	50	55	Blue
MBBA001	50	2	50	55	Black
MBBA002	50	2	50	55	Red

Polyester Jackstay Webbing

- Exceeds current R.O.R.C. special regulations.
- Available only on full reels.

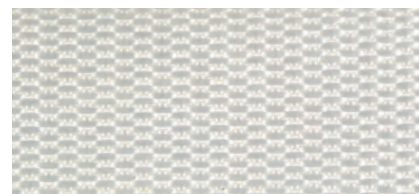

Part No.	Width: mm/in		Reel Length: m/yd		Breaking Strength: kg/lb		Colour
E150	25	1	50	55	3000	6613	White

Insignia Cloth & Insignia Tape

Colour Availability

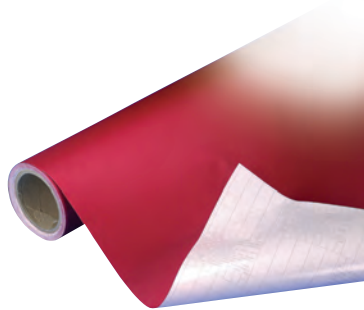
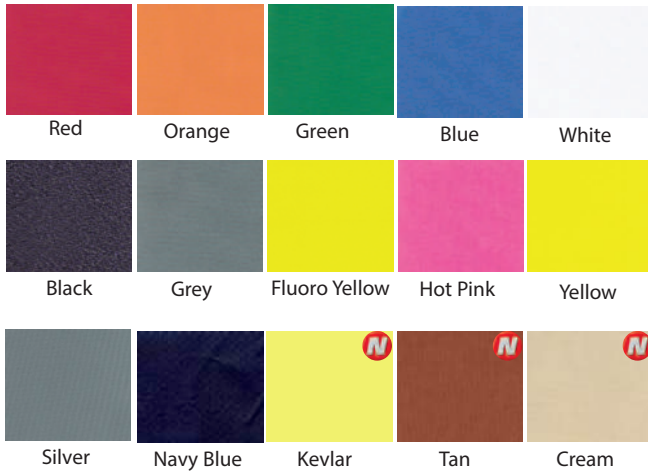

Polyester Insignia

- Standard style.
- Cut lengths available.

Part No.	Roll Width: mm/in		Roll Length: m/yd		Colour
J514RD	1370	54	45.7	50	Red
J514OR	1370	54	45.7	50	Orange
J514GR	1370	54	45.7	50	Green
J514BU	1370	54	45.7	50	Blue
J514BK	1370	54	45.7	50	Black
J514GY	1370	54	45.7	50	Grey
J514WT	1370	54	45.7	50	White
J514FP	1370	54	45.7	50	Hot Pink
J514FY	1370	54	45.7	50	Fluoro Yellow
J514YE	1370	54	45.7	50	Yellow
J514SL	1370	54	45.7	50	Silver
J514NB	1370	54	45.7	50	Navy Blue
J514KE	1370	54	45.7	50	Kevlar
J514CR	1370	54	45.7	50	Cream
J514TN	1370	54	45.7	50	Tan

Polyester Insignia Printable & UV

- J530WT - High tack Polyester Insignia cloth, aggressive glue, no grid on paper, cut lengths available.
- J530WTUV - Titanium Dioxide pigment coating applied for the best UV protection, acrylic adhesive, works for most solvent digital inkjet printing.
- J614WT - Acrylic adhesive, works for most solvent digital inkjet printing.

Part No.	Roll Width: mm/in		Roll Length: m/yd		Colour
J530WT	1370	54	45.7	50	White
J530WTUV	1370	54	45.7	50	White UV
J614WT	1370	54	45.7	50	White

Other colours available against special order. All special order items are subject to minimum order quantities and additional lead times. Prices on application.



PVC (Vinyl) Insignia Cloth

- Adhesive backed vinyl material with a semi-gloss finish for numbers, letters and graphic designs.

Part No.	Tape Width: mm/in		Roll Length: m/yd		Colour
J550WT	69	27	46	50	White
J550BK	69	27	46	50	Black
J550RD	69	27	46	50	Red

Draft Stripe - Camber/ Fast Stripe

- Available only on full rolls, length is approximate.



Part No.	Roll Width: mm/in		Roll Length: m/yd		Colour
J015RD	15	$\frac{5}{8}$	45.7	50	Red
J015OR	15	$\frac{5}{8}$	45.7	50	Orange
J015BU	15	$\frac{5}{8}$	45.7	50	Blue
J015BK	15	$\frac{5}{8}$	45.7	50	Black
J015GY	15	$\frac{5}{8}$	45.7	50	Grey
J015WT	15	$\frac{5}{8}$	45.7	50	White
J020RD	20	$\frac{7}{8}$	45.7	50	Red
J020OR	20	$\frac{7}{8}$	45.7	50	Orange
J020GR	20	$\frac{7}{8}$	45.7	50	Green
J020BU	20	$\frac{7}{8}$	45.7	50	Blue
J020BK	20	$\frac{7}{8}$	45.7	50	Black
J020GY	20	$\frac{7}{8}$	45.7	50	Grey
J020WT	20	$\frac{7}{8}$	45.7	50	White
J020FY	20	$\frac{7}{8}$	45.7	50	Fluoro Yellow
J025RD	25	1	45.7	50	Red
J025OR	25	1	45.7	50	Orange
J025GR	25	1	45.7	50	Green
J025BU	25	1	45.7	50	Blue
J025BK	25	1	45.7	50	Black
J025GY	25	1	45.7	50	Grey
J025WT	25	1	45.7	50	White
J025FY	25	1	45.7	50	Fluoro Yellow
J040RD	40	$1\frac{1}{2}$	45.7	50	Red
J040BU	40	$1\frac{1}{2}$	45.7	50	Blue
J040BK	40	$1\frac{1}{2}$	45.7	50	Black
J040WT	40	$1\frac{1}{2}$	45.7	50	White
J050RD	50	2	45.7	50	Red
J050BU	50	2	45.7	50	Blue
J050BK	50	2	45.7	50	Black
J050GY	50	2	45.7	50	Grey
J050WT	50	2	45.7	50	White
J060WT	60	$2\frac{3}{8}$	45.7	50	White
J075RD	75	$2\frac{3}{4}$	45.7	50	Red
J075BU	75	$2\frac{3}{4}$	45.7	50	Blue
J075BK	75	$2\frac{3}{4}$	45.7	50	Black
J075WT	75	$2\frac{3}{4}$	45.7	50	White
J080WT	80	$3\frac{1}{8}$	45.7	50	White
J100WT	100	4	45.7	50	White
J125WT	125	5	45.7	50	White
J150WT	150	6	45.7	50	White
J200WT	200	8	45.7	50	White
J250WT	250	10	45.7	50	White

Sail Repair

Sail Repair Kit

- By William Smith manufacturer of palms and needles.



Part No.	Description
C038	Repair kit containing adjustable palm/wax/tube of 10 needles/thread
C038L	Repair kit containing left-handed palm
C039	Repair kit containing lightweight palm/tube of 5 needles/thread

Dacron Sail Repair Tape

- Manufactured from Dacron Insignia cloth with very aggressive adhesive.

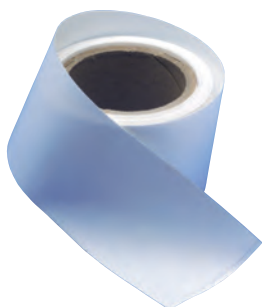

Part No.	Roll Length: m/ft		Width: mm/in	
J610WT	4.5	15	50	2
J613WT	4.5	15	75	3
J073	45	150	75	3

Adhesive Remover

A specially blended solvent that provides easy cleanup of most types of adhesive and quickly removes waxes, road tars, grease, oil and similar materials. Will not harm vinyl or fabrics when properly used. Always try on a small area of similar material before use on a sail or cover

- Easy to apply.
- Non-Toxic.
- Non-Allergenic.
- Much safer than acetone.



Part No.	Liquid Measure: ml/oz	
M040	909	32

Sail RIPair® Tape - Nylon

- Available only on full rolls.



Part No.	Roll Width: mm/in		Roll Length: m/ft		Color
J601RD	50	2	7.6	25	Red
J601GD	50	2	7.6	25	Gold
J601GR	50	2	7.6	25	Green
J601BU	50	2	7.6	25	Blue
J601LB	50	2	7.6	25	Light Blue
J601PU	50	2	7.6	25	Purple
J601BK	50	2	7.6	25	Black
J601WT	50	2	7.6	25	White
J601HP	50	2	7.6	25	Hot Pink
J601SR	50	2	7.6	25	Silver

Sail RIPair® Tape Box

- For resale of J601.
- Clear cellophane window for view of tape color within.
- Slotted hanging hole for display on pegboard or slatwall display racks.



Part No.	Description
J602	Tape Box

Examples of Dinghy and Keelboat Insignia

Pre-cut class insignia to meet the rules of various popular one-design classes.

- Precision die cut from self-adhesive polyester fabric.
- Available in standard colours of Red/Blue/Black or as Class rules specify.
- Priced in full packs of 5 pairs. (10 pieces) Individual pairs surcharged 25%.



Albacore



Europe



Finn



Fireball



470



Flying Fifteen



GP14

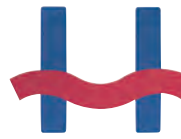

H-Boat



J22



J24



Kestrel



Merlin Rocket



Miracle



Mirror

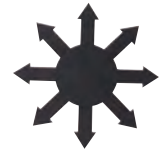

Moody



OK



Optimist



Pirate



Scorpion



Snipe



Solo



Topper



Wayfarer



Westerly



Yngling

Part No.	Class
INS001 / BU	Albacore
INS007B/R	Europe
INS009BU / RD	Finn
INS011RD	Fireball
INS017BU	470
INS019	Flying Fifteen
INS023BK	GP14
INS027B/R	H-Boat
INS028BU	J22
INS029BU	J24
INS031	Kestrel
INS033BK	Merlin Rocket

Part No.	Class
INS037RD	Miracle
INS039BK	Mirror
INS041BK	Moody
INS045RD	OK
INS047	Optimist
INS051	Pirate
INS055	Scorpion
INS059	Snipe
INS061	Solo
INS067BK	Topper
INS071RD	Wayfarer
INS073BK	Westerly
INS075	Yngling

Other colours can be supplied against special order.
 Other custom designs available against special order - please request quote for die.
 All special order items are subject to additional lead times. Prices on application.



Sail Numbers

Sail Numbers

Numbers are cut from self adhesive fabric, which is compatible with all types of Dacron® and polyester sailcloth. When ordering please add the colour and number at the end of the part number, eg: SN230BK0. Priced and available in full packs of 10 identical numbers.



Plain Style



Computer Eights



Stylised - SN001

Plain Style Sail Numbers

Part No.	SN100	SN150	SN225	SN230	SN250	SN300	SN380	SN450
Actual Size: mm/in	101 4	150 5 7/8	227 9 9/32	236 9 9/16	250 9 27/32	307 12 1/16	394 15 1/2	457 18
Suitability for Rule	-	-	IBSA	ISAF <3.5m	-	ISAF 3.5-8.5m	ISAF 8.5-11m	ISAF >11m
Pack Qty	10	10	10	10	10	10	10	10

0	▲	▲	●	●	▲	●	●	▲
1	▲	▲	●	●	▲	●	●	▲
2	▲	▲	●	●	▲	●	●	▲
3	▲	▲	●	●	▲	●	●	▲
4	▲	▲	●	●	▲	●	●	▲
5	▲	▲	●	●	▲	●	●	▲
6/9	▲	▲	●	●	▲	●	●	▲
7	▲	▲	●	●	▲	●	●	▲
8	▲	▲	●	●	▲	●	●	▲

Computer Eights

Part No.	SC225	SC230	SC250	SC300	SC380	SC450
Actual Size: mm/in	231 9 3/32	236 9 9/32	255 10 1/16	305 12	385 15 1/8	451 17 3/4
Suitability for Rule	-	ISAF <3.5m	-	ISAF 3.5-8.5m	ISAF 8.5-11m	ISAF >11m
Pack Qty	10	10	10	10	10	10

8	▲	●	▲	●	●	▲
---	---	---	---	---	---	---

Stylised Sail Numbers

Part No.	SN001
Actual Size: mm/in	102 4 1/32
Suitability for Rule	-
Pack Qty	10
1-9	▲

Key

- Stock item in Black, Blue or Red.
- ▲ Non stock items, can be cut on request.

All sail numbers detailed are available to special order in any colour from the Polyester Insignia range. All special orders are subject to additional lead times. Prices on application.



Sail Letters

Letters are cut from self adhesive fabric, which is compatible with all types of Dacron® and polyester sailcloth.
 When ordering please add the colour and number at the end of the part number, eg: SL230BKA.
 Priced and available in full packs of 10 identical numbers.
 SD002 Dots and SL002 Circles are also available, please enquire for details.



Plain Style



Stylised - SL001

Plain Style Sail Letters

Part No.	SL001	SL225	SL230	SL250	SL300	SL380	SL450
Actual Size: mm/in	101 4	227 8 ²⁹ / ₃₂	235 9 ⁹ / ₁₆	250 9 ²⁷ / ₃₂	305 12	394 15 ¹ / ₂	458 18 ¹ / ₁₆
Suitability for Rule	-	IBSA	ISAF <3.5m	-	ISAF 3.5-8.5m	ISAF 8.5-11m	ISAF >11m
Pack Qty	10	10	10	10	10	10	10
A	▲	▲	● bk	▲	● bk/bu	▲	▲
B	▲	▲	● bk	▲	● bk/bu/rd	● bk	▲
C	▲	▲	▲	▲	▲	▲	▲
D	▲	▲	▲	▲	● bk/bu	▲	▲
E	▲	▲	● bk	▲	● bk/bu/rd	● bu	▲
F	▲	▲	▲	▲	● bk/bu/rd	▲	▲
G	▲	▲	● bk	▲	● bk/bu/rd	● bk	▲
H	▲	▲	▲	▲	■	▲	▲
I	▲	▲	▲	▲	▲	▲	▲
J	▲	▲	■	▲	■	■	■
K	▲	▲	■	▲	▲	▲	▲
L	▲	▲	▲	▲	● bk	▲	■
M	▲	▲	■	▲	▲	▲	■
N	▲	▲	▲	▲	● bk/bu	● bu	▲
O	▲	▲	▲	▲	▲	▲	▲
P	▲	▲	▲	▲	▲	■	■
Q	▲	▲	■	▲	■	■	■
R	▲	▲	● bk	▲	● bk/bu/rd	● bk/bu	▲
S	▲	▲	● bk	▲	● bk/bu	▲	■
T	▲	▲	▲	▲	▲	▲	■
U	▲	▲	▲	▲	▲	▲	■
V	▲	▲	■	▲	■	■	■
W	▲	▲	▲	▲	bk	▲	■
X	▲	▲	■	▲	■	■	■
Y	▲	▲	■	▲	■	▲	▲
Z	▲	▲	■	▲	■	■	■

Key

- Stock item in Black, Blue or Red.
- ▲ Non stock items, can be cut on request.
- No die available for these letters. Quotation for custom die available on request.

All sail letters detailed are available to special order in any colour from the Polyester Insignia range.
 All special orders are subject to additional lead times. Prices on application.



Seaming Tapes

PSA Aramid Patch

Kevlar with self adhesive backing. Ideal for lightweight corner patches and local reinforcement on laminate sails. Available in full width cut lengths or as rolls of tape.



Part No.	Width: mm/in	Weight: gsm/sm oz	Material
F7010Z00M	1370 54	210 6.5	Kevlar

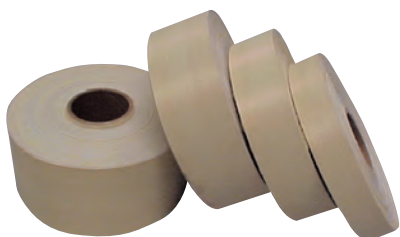

Part No.	Tape Width: mm/in	Roll Length: m/yd
J742	50 2	27 - 55 30 - 60
J743	75 3	27 - 55 30 - 60
J744	102 4	27 - 55 30 - 60

Polyester Sailcloth with Adhesive

- Bainbridge quality polyester sailcloth in three weights with our unique adhesive backing and release paper.
- Make a quick easy patch that sticks exactly to the location it is placed.
- Some applications may require sewing for additional strength.



Part No.	Material	Width: mm/in	Roll Length: m/yd	Colour
J665W	6.5 oz. Polyester	1320 52	32 35	White
J686W	8.0 oz. Polyester	1320 52	32 35	White

Seaming Tapes

Bainbridge International stocks many styles of double sided adhesive tapes for holding components such as panels and patches in place before sewing. The tapes offered vary in type and degree of adhesion as well as carrier and component construction.

3M VHB Attachment Tape

- High performance acrylic adhesive.
- Medium density white acrylic foam tape.
- Adhesive on both sides with red release liner.
- Use: Attaching automotive and marine trim, awning track, flex a rail.



Part No.	Width: mm/in	Roll Length: m/yd
J112V	12.7 1/2	18 20
J117V	22.5 7/8	18 20

Economy Grade Seaming Tape - Acrylic Based Adhesive - Tissue Carrier

- Economy grade seaming tape offering excellent value for money.
- Fair initial tack.
- High long term adhesion.
- Tissue Carrier.
- Non yellowing.

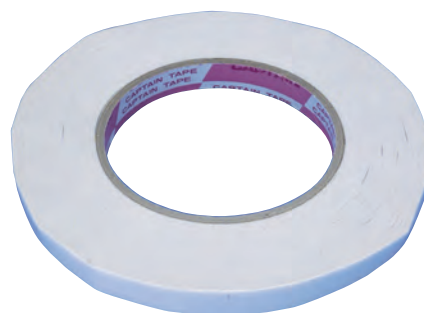

Part No.	Width: mm/in	Roll Length: m/yd
J411	6 1/4	50 54.7
J412	9 3/8	50 54.7
J413	12 1/2	50 54.7
J414	15 5/8	50 54.7
J415	19 3/4	50 54.7
J416	25 1	50 54.7
J417	30 1 3/16	50 54.7
J419	14 9/16	50 54.7

Seam Bonding Tape

Super Tack Seaming Tape - Acrylic Based Adhesive

- Ultra-high tack.
- Specially developed by Bainbridge International for use with acrylic cover fabric.
- CAUTION: Not to be used on vinyls or vinyl window materials.

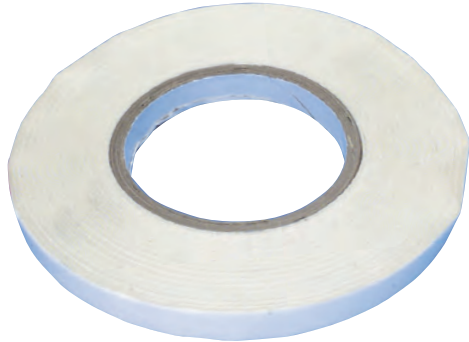

Part No.	Width: mm/in		Roll Length: m/yd	
J472	9	3/8	32.9	36

Seaming Tape - Acrylic Based Adhesive - Mylar Carrier

- High quality double sided tape for general sail seaming.
- Fair initial tack.
- High long term adhesion.
- Low stretch mylar carrier.
- Non yellowing.

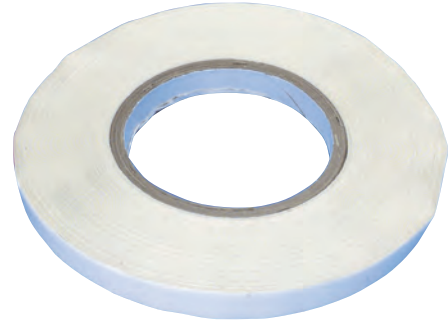

Part No.	Width: mm/in		Roll Length: m/yd	
J451	6	1/4	65.8	72
J452	9	3/8	65.8	72
J453	12	1/2	65.8	72
J455	19	3/4	65.8	72
J456	25	1	65.8	72

High Adhesion Seaming Tape - Acrylic Based Adhesive - Tissue Carrier

- Outstanding adhesion to all types of sailcloth making this tape ideal for seaming applications.
- Good initial tack.
- High long term adhesion.
- Tissue carrier.
- Non yellowing.



Part No.	Width: mm/in		Roll Length: m/yd	
J310	6	1/4	50	54.7
J311	9	3/8	50	54.7
J312	12	1/2	50	54.7
J313	15	5/8	50	54.7
J314	19	3/4	50	54.7
J315	25	1	50	54.7

Mylar/Kevlar Seaming Tape (Temperkote) - Acrylic Based Adhesive - Fabric Carrier

- Designed for film/film laminate sails, cloth carrier strengthens seam and re-inforces stitching.
- Fair initial tack.
- High long term adhesion.
- Cloth Carrier.
- Non yellowing.

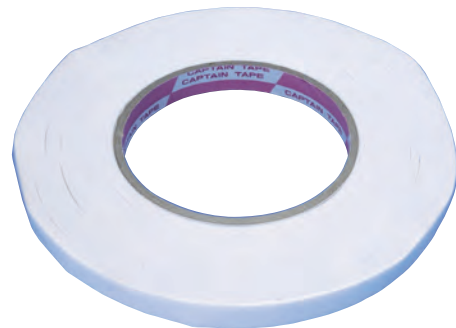

Part No.	Width: mm/in		Roll Length: m/yd	
J080	12	1/2	45.7	50
J082	25	1	45.7	50

3M Seaming Tapes

3M Super Seam Tapes

3M Super Seam Tape is suitable for bonding spinnakers and low load radial seams on head sails made from film laminate sailcloth. Used on higher load horizontal seams, the number of rows of stitching can safely be reduced.

Sails for dinghies, sports boats and small IMS yachts up to 36ft have been assembled using 3M super seam tape.

Advantages of bonding sails with 3M Super Seam Tape.

- Super Seam Tape is better for the sailcloth, particularly on film/ film laminates and nylons where stitching can tear through the cloth.
- Super Seam Taped seams often stretch less than conventional sewn seams.
- Super Seam Tape can reduce costs as the number of rows of stitching on horizontal seams of large sails can be reduced.
- Seams bonded with Super Seam Tape are light and smooth.

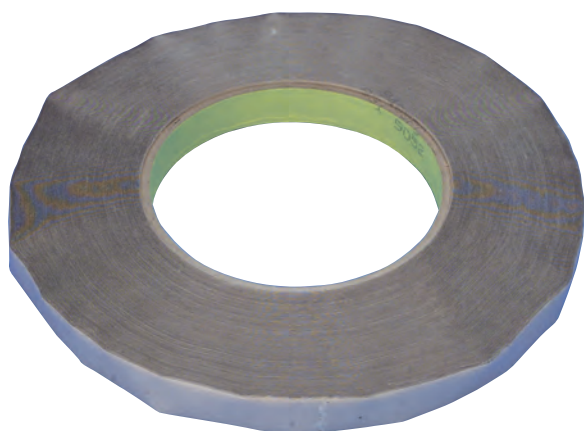

Part No.	Width: mm/in		Roll Length: m/yd	
J180	12	1/2	55	60
J181	19	3/4	55	60
J182	25	1	55	60

3M Acrylic Transfer Tape

- High performance transfer tape, more elastic than conventional double sided tapes.
- Transfer tapes do not have a film or cloth carrier.
- Non-yellowing.
- Uses: Excellent for spinnakers and light sails where some stretch in the seam is desired.

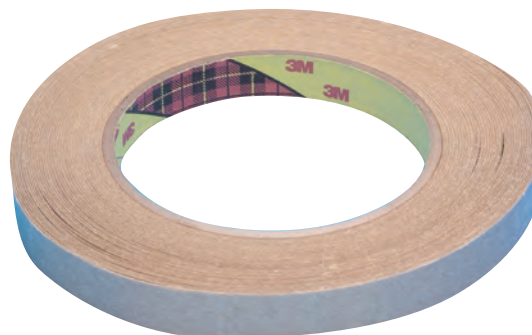

Part No.	Width: mm/in		Roll Length: m/yd	
J132	10	3/8	55	60
J133	12	1/2	55	60
J134	20	3/4	55	60



Application of 3M Super Seam Tape

It is important that the following instructions are adhered to:

- Select width tape based on seam width and shear strength requirements.
- Use only on film surfaces of laminate sail cloths.
- Areas to be bonded must be clean and free from grease.
- Do not touch the areas to be bonded.
- Rub down or apply pressure with a roller to all seams after bonding.
- Allow the finished sail to lie flat for 24 hours before use.
- Do not use on horizontal or highly loaded seams of fore and aft sails without additional stitching.
- Do not use with silicone finished fabrics.

Seam Roller

- Use for applying pressure to seams bonded with 3M Super Seam Tape.



Part No.	Description
C523	Seam Roller



YKK® Zips

YKK® Zips

YKK® zips offered by Bainbridge International have been engineered especially for the marine industry and other outdoor applications. All materials used have been selected to resist damage from ultraviolet rays and corrosion.

Vislon Continuous Zipper - Size 5

- Cut-to-length pieces available.
- Slide supplied only in packs of 10.



E581 E583

Part No.	Description	Width: mm/in	Reel Length: m/yd	Colour
E580	Vislon No.5	30 1 3/16	200 219	White
E581	Single Metal Slide			White
E583	Single Plastic Slide			White

Note: Metal slides are normally supplied in white but may be Nickel finished in exceptional circumstances.

Vislon Continuous Zipper - Size 10

- Cut-to-length pieces available.
- Slide supplied only in packs of 10.

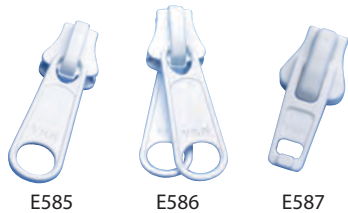
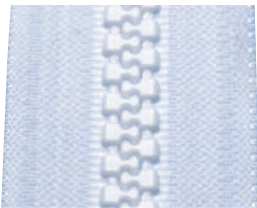

E585 E586 E587

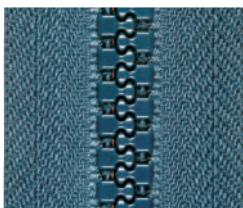

E585NB E586NB

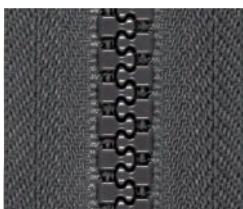

E585BK E586BK

Part No.	Description	Width: mm/in	Reel Length: m/yd	Colour
E584	Vislon No. 10	38 1 1/2	100 109	White
E584NB	Vislon No. 10	38 1 1/2	100 109	Navy Blue
E584BK	Vislon No. 10	38 1 1/2	100 109	Black
E585	Single Metal Slide			White
E585NB	Single Metal Slide			Navy Blue
E585BK	Single Metal Slide			Black
E586	Double Metal Slide			White
E586NB	Double Metal Slide			Navy Blue
E586BK	Double Metal Slide			Black
E587	Single Plastic Slide			White

Note: Metal slides are normally supplied in white but may be Nickel finished in exceptional circumstances.

Coil Continuous Zipper - Size 5

- Cut-to-length pieces available.
- Slide supplied only in packs of 10.

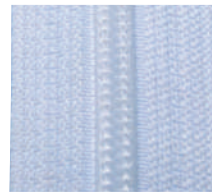

E589

Part No.	Description	Width: mm/in	Reel Length: m/yd	Colour
E588	Coil No. 5	31 1 1/4	200 219	White
E589	Single Metal Slide			White

Note: Metal slides are normally supplied in white but may be Nickel finished in exceptional circumstances.

Jacket Type Zipper - #5 Vislon

- #5 white Vislon zipper with single metal sliders.



Part No.	Size	Length: mm/ft	Colour
E598WT	No. 5	6710 22.0	White

Jacket Type Zipper - #10 Vislon

- #10 Vislon zipper with double metal sliders.
- Other colours available against special order.

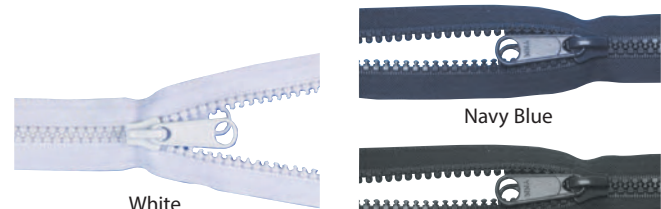

White

Navy Blue

Black

Part No: White	Part No: Blue	Part No: Black	Length: mm/ft	
E560WT	E560NB	E560BK	610	2.0
E571WT	E571NB	E571BK	762	2.5
E561WT	E561NB	E561BK	910	3.0
E562WT	E562NB	E562BK	1060	3.5
E563WT	E563NB	E563BK	1220	4.0
E564WT	E564NB	E564BK	1370	4.5
E565WT	E565NB	E565BK	1520	5.0
E566WT	E566NB	E566BK	1680	5.5
E567WT	E567NB	E567BK	1830	6.0
E568WT	E568NB	E568BK	1980	6.5
E570WT	E570NB	E570BK	2130	7.0
E572WT	E572NB	E572BK	2440	8.0
E574WT	E574NB	E574BK	2740	9.0
E576WT	E576NB	E576BK	3050	10.0
E577WT	E577NB	E577BK	3660	120.0
E578WT	E578NB	E578BK	4570	15.0
E600WT	-	-	6710	22.0
E569WT	-	-	10000	32.8

YKK® Zips & Cleaner

Dragon Class Zipper - #10 Vislon

- #10 white Vislon zipper with single metal sliders.



Part No.	Size	Length: mm/ft		Colour
E579WT	10	5950	19.5	White

Coil Continuous Zipper - Size 10

- Cut-to-length pieces available.
- Slide supplied only in packs of 10.

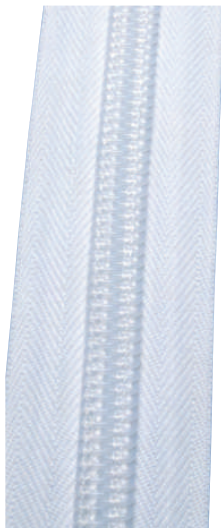

E592



E593

Part No.	Description	Width: mm/in	Reel Length: m/yd	Colour
E591	Coil No. 10	40 1 9/16	100 109	White
E592	Single Metal Slide			White
E593	Double Metal Slide			White
E594	Double Metal Slide			Nickel

Note: Metal slides are normally supplied in white but may be Nickel finished in exceptional circumstances.

In addition to standard White and Navy, all zips are available in a large range of colours including Mid Blue, Green, Burgundy, Beige, French Blue, Grey, Red and Black. Please note minimum order quantities may apply.



Poly Velcro®

- Poly Velcro offers improved UV resistance. It does not absorb moisture like nylon hook and loop can, and exhibits less shrink than nylon.
- Available only on full reels.

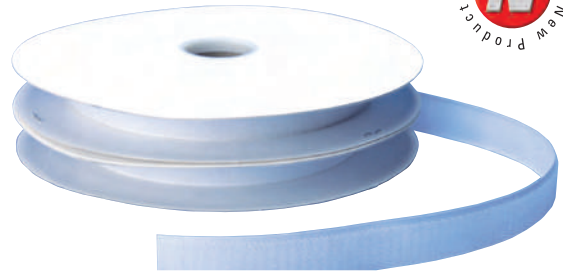

Part No.	Size: mm/in	Reel Length: m/yd	Description
E670HWT	50 2	23 25	White Hook
E670LWT	50 2	23 25	White Loop

Zippy Cool - Zipper Lube and Cleaners

- Effective "no-silicon" way to clean and lubricate all types of zipper.



Part No.	Description
M030	Zippy Cool Kit (M031 & M032)
M031	Zippy Cool Cleaning Fluid and Lubricant with Brush
M032	Zippy Cool Wax Lubricant

Coloured Velcro® - Twin Hook and Loop

- Durable hook fastening (as opposed to the less expensive "mushroom" type) gives maximum life cycle.
- Twin metre comprising 25 metre hook and 25 metre loop.
- Available only on full reels.

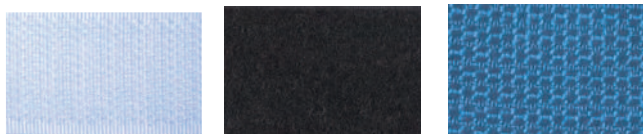
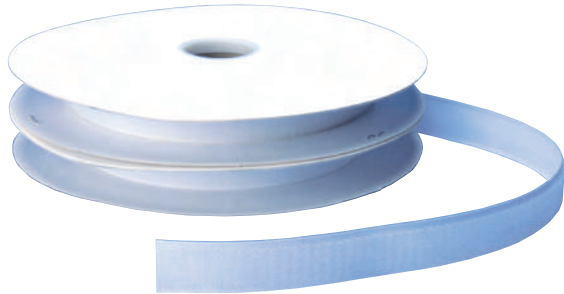

Part No.	Size: mm/in		Reel Length: Twin m/yd		Colour
E500	15	5/8	25	27.3	White
E510	20	3/4	25	27.3	White
E511	20	3/4	25	27.3	Black
E512	20	3/4	25	27.3	Blue
E515	25	1	25	27.3	White
E517	25	1	25	27.3	Black
E520	30	1 1/4	25	27.3	White
E521	30	1 1/4	25	27.3	Black
E522	30	1 1/4	25	27.3	Blue
E530	50	2	25	27.3	White
E531	50	2	25	27.3	Black
E532	50	2	25	27.3	Blue

Coloured Velcro® - Hook Only

- Durable hook fastening (as opposed to the less expensive "mushroom" type) gives maximum life cycle.
- Available only on full reels.

Part No.	Size: mm/in		Reel Length: m/yd		Colour
E500H	15	5/8	25	27.3	White
E510H	20	3/4	25	27.3	White
E511H	20	3/4	25	27.3	Black
E512H	20	3/4	25	27.3	Blue
E515H	25	1	25	27.3	White
E517H	25	1	25	27.3	Black
E520H	30	1 1/4	25	27.3	White
E521H	30	1 1/4	25	27.3	Black
E522H	30	1 1/4	25	27.3	Blue
E530H	50	2	25	27.3	White
E531H	50	2	25	27.3	Black
E532H	50	2	25	27.3	Blue

Coloured Velcro® - Loop Only

Part No.	Size: mm/in		Reel Length: m/yd		Colour
E500L	15	5/8	25	27.3	White
E510L	20	3/4	25	27.3	White
E511L	20	3/4	25	27.3	Black
E512L	20	3/4	25	27.3	Blue
E515H	25	1	25	27.3	White
E517H	25	1	25	27.3	Black
E520L	30	1 1/4	25	27.3	White
E521L	30	1 1/4	25	27.3	Black
E522L	30	1 1/4	25	27.3	Blue
E530L	50	2	25	27.3	White
E531L	50	2	25	27.3	Black
E532L	50	2	25	27.3	Blue



Heminway & Bartlett Thread

Dabond® Machine Threads

Heminway & Bartlett Dabond 2000 thread sets industry standards due to its:

- High strength and controlled stretch.
- Resistance to abrasion and salt water.
- Stability in sunlight and resistance to mildew.
- Bonding and resistance to needle heat.
- Continuous thread: no knots/breaks in thread.



Heminway & Bartlett Dabond® 2000 Nano Thread

- These threads are produced with carefully controlled materials and processes and can normally be used with a wide variety of sailcloth.
- Dabond® 2000 thread is available in other colours against special order.
- Normally put up on 450g (1lb) spools.
- Some colours available on 225g (8oz) spools.
- Maxi sized spools that hold substantially more thread than some competitors.

Part No.	Average Spool Size: gm/oz	Dabond® Size	Nearest Metric Size	Colour
ET030WT	450 16	V30	NM80	Natural
ET046WT	450 16	V46	NM60	Natural
ET046BU	450 16	V46	NM60	Blue
ET046BK	450 16	V46	NM60	Black
ET069WT	450 16	V69	NM36	Natural
ET069RD	450 16	V69	NM36	Red
ET069GR	450 16	V69	NM36	Green
ET069BU	450 16	V69	NM36	Blue
ET069BK	450 16	V69	NM36	Black
ET069GY	450 16	V69	NM36	Grey
ET069TN	450 16	V69	NM36	Tan
ET092WT	450 16	V92	NM25	Natural
ET092RD8	225 8	V92	NM25	Red
ET092GR8	225 8	V92	NM25	Green
ET092BU	450 16	V92	NM25	Blue
ET092BK	450 16	V92	NM25	Black
ET092GY8	225 8	V92	NM25	Grey
ET092TN8	225 8	V92	NM25	Tan
ET138WT	450 16	V138	NM20	Natural
ET138BU	450 16	V138	NM20	Blue
ET138BK	450 16	V138	NM20	Black
ET138GY	450 16	V138	NM20	Grey
ET138RD	450 16	V138	NM20	Red
ET138TN	450 16	V138	NM20	Tan
ET207WT	450 16	V207	NM13	Natural
ET346WT	450 16	V346	NM8	Natural

Thread Selection Chart

Dabond® Part No.	Needle Size: Imperial/Metric	Average Yield: m/yd per lb	Average Tensile: kg/lb
V30	11-14 75-90	12,951 14,170	2.13 4.7
V46	12-15 80-95	7,467 8,170	3.36 7.4
V69	15-18 95-110	5,110 5,590	4.95 10.9
V92	17-20 105-125	3,866 4,230	6.58 14.5
V138	19-21 120-130	2,523 2,760	10.26 22.6
V207	21-23 130-160	1,682 1,840	14.71 32.4
V346	- 23-26	1,005 1,100	26.38 58.1

Heminway & Bartlett Bonded Nano Polyester "Anti-Wick" Thread

Heminway and Bartlett "Anti-Wick" thread has been designed for outdoor applications. As well as having high strength and good UV resistance, it reduces the penetration of water through the stitching.

- Supplied on tubes of 450gm (1lb) nominal weight.
- "Anti-Wick" thread is ideally suited for tents/boat tops/awnings/duffle bags and other outdoor products subject to water seepage through seams.
- "Anti-Wick" combines superior sewability and a permanent anti-wick additive that blocks water migration through seams and meets MIL SPEC V-T-285 Type II.
- Maxi sized spools hold substantially more thread than some competitors.



Part No.	Dabond® #	Nearest Metric Size	Colour
EA069WT	V69	NM36	White
EA069BK	V69	NM36	Black
EA069PB	V69	NM36	Pacific Blue (Neptune)
EA092WT	V92	NM25	White
EA092BK	V92	NM25	Black
EA092PB	V92	NM25	Pacific Blue (Neptune)
EA092GY	V92	NM25	Silver Grey
EA092BU	V92	NM25	Blue
EA138WT	V138	NM20	White
EA138BK	V138	NM20	Black

CAUTION

It is occasionally possible for fabrics to be sewn to contain agents which encourage pigment migration from coloured threads. We recommend that the following test is carried out before use.

Take a small coil of thread and place between two pieces of the chosen fabric, dampened. Place a 5kg/10lb weight on top and leave for 24 hours after which check if any pigment migration has occurred. Do NOT use if there is any doubt concerning pigment migration.

"Anti-Wick" Thread & Bobbins

Bainbridge "Anti-Wick" Thread

- Thread is supplied on special 8oz spools and is sold per spool.
- Bonded Poly.
- ANti-Wick thread.
- Colours match most popular Sunbrella colours.
- 220g/8 ounce spools.



92 Part No.	138 Part No.	Colour
EY092BEG8	EY138BEG8	Beige
EY092BG8	EY138BG8	Burgundy
EY092BK8	EY138BK8	Black
EY092BRN8	EY138BR8	Brown
EY092CNV8	EY138CNV8	Captain Navy
EY092FGR8	EY138FGR8	Forest Green
EY092GY8	EY138GY8	Grey
EY092JRD8	EY138RD8	Jockey Red
EY092LN8	EY138LN8	Linen
EY092LRD8	EY138LRD8	Logo Red
EY092NV8	EY138NV8	Navy
EY092PB8	EY138PB8	Pacific Blue
EY092SR8	EY138SR8	Silver
EY092TS8	EY138TS8	Toast
EY092WT8	EY138WT8	White



It is occasionally possible for fabrics to be sewn to contain agents which encourage pigment migration from coloured threads. We recommend that the following test is carried out before use.

Take a small coil of thread and place between two pieces of the chosen fabric, dampened. Place a 5kg/10lb weight on top and leave for 24 hours after which check if any pigment migration has occurred. Do NOT use if there is any doubt concerning pigment migration.

Dabond® Pre-Wound Bobbins

Heminway & Bartlett Pre-Wound bobbins are wound on a thin core and therefore can have up to 30% more thread per bobbin than can be wound on by a sewing machine. Saves time and effort with fewer bobbin changes and longer continuous seams.

- Hembobbs are supplied only in full packs of 144 bobbins.



Part No.	Dabond® Type	Colour	Pack Qty
EB046DWT	V46 Type D	Natural	144
EB046FWT	V46 Type F	Natural	144
EB046GWT	V46 Type G	Natural	144
EB069DWT	V69 Type D	Natural	144
EB069FWT	V69 Type F	Natural	144
EB069GWT	V69 Type G	Natural	144
EB069LWT	V69 Type L	Natural	144
EB092DWT	V92 Type D	Natural	144
EB092FWT	V92 Type F	Natural	144
EB092GWT	V92 Type G	Natural	144
EB092LWT	V92 Type L	Natural	144

Bobbin Selection Chart

Sewing Machine	Type	Diameter: mm/in		Thickness: mm/in	
Adler 67	G	21.0	0.83	11.0	0.43
Adler 98	F	25.0	0.98	7.0	0.27
Bernina 217	D	21.8	0.86	7.6	0.30
Conscrew 98	L	20.0	0.79	8.0	0.31
Juki LU562	G	21.0	0.83	11.0	0.43
Pfaff 138/238	L	20.0	0.79	8.0	0.3
Singer 61	D	21.8	0.86	7.6	0.30
Singer 107/143/457	F	25.0	0.98	7.0	0.27
Singer 111/112/167/211G151/212	G	21.0	0.83	11.0	0.43

Solarfix High Performance Sewing Thread

- SolarFix PTFE thread will not break due to exposure to sunlight, weather or water for the life of the fabric sewn.
- Exceptional resistance to UV and atmospheric degradation.
- SolarFix thread will not lose any significant strength due to UV.
- Limited lifetime warranty



Part No.	Approx dtex	Approx Tex	Colour
EF1500CH1T	1500	92	Clear
EF1500DH1T	1500	92	Black
EF1500WH1T	1500	92	White
EF2640CH1T	2640	138	Clear
EF2640DH1T	2640	138	Black
EF2640WH1T	2640	138	White

Heminway & Bartlett Pre-Waxed Hand Sewing Thread

- Supplied on spools.
- Available only in white.



Part No.	Description	Spool Weight: kg/lb	
EW346	V-346	0.45	1
EW462	V-462-M	0.45	1
EW499	V-9-C	0.45	1

Waxed Sailtwine Bobbins

- Pre-Waxed thread equivalent to EW499 wound into bobbins.
- Ideal for sail repair kits.
- Sailtwine is sold in full packs only. 12 bobbins per pack.
- Approximately 27 yards/24 metres per bobbin.



Part No.	Description	Pack Qty
EW500	V6M	12

Waxed Lacing Tape

- Flat braided to lie flatter than normal.



Part No.	Spool Length: m/yd		Width: mm/in	
EW351	457	500	1.6	0.06
EW352	457	500	3.2	0.125

Sewing Thread

Waxed Threads

- White waxed thread ideal for repair kits.



Part No.	Description
ET353	1oz./30g Sewing thread

Sailmakers Wax

- C040 Natural bees wax.
- C041 Composition bees wax.



Part No.	Description
C040	85g/3oz Cup of thread wax
C041	454g/16oz Block of thread wax

Whipping Twine

- Waxed polyester twine available in a variety of sizes and colours.



Part No.	Type	Diameter: mm/in	Reel Length: m/yd	Colour
MTAE000	No. 2	0.5 $\frac{3}{64}$	92 100	White
MTAE001	No. 4	0.8 $\frac{1}{32}$	41 45	White
MTAE002	No. 4	0.8 $\frac{1}{32}$	41 45	Red
MTAE003	No. 4	0.8 $\frac{1}{32}$	41 45	Blue
MTAE004	No. 4	0.8 $\frac{1}{32}$	41 45	Green
MTAE016	No. 4	0.8 $\frac{1}{32}$	41 45	Black
MTAE015	No. 4	0.8 $\frac{1}{32}$	41 45	Gold
MTAE005	No. 8	1.1 $\frac{1}{16}$	23 25	White
MTAE006	No. 16	1.5 $\frac{1}{16}$	12 13	White



Tools

Thread lubricants & Accessories	70
Palms & Needles	71
Sewing Accessories	72
Cutting & Sealing Tools	73
Hot Knives & Scissors	74
Scissors & Shears	75
Benchwork & Finishing Accessories	76
Hole Punching Tools	77
Pattern Making & Lofting	78
Measuring & Marking	79
Seam Sealers & Lubricants	80
Cleaners & Polish	81
Protectants & Adhesives	82
Repairs Kits	83-84

Thread Lubricants

Thread Lubricant

- M301 - Non-toxic combination of petroleum lubricants and silicone oils. Thread is dipped for a few minutes into the lubricant for application.
- M305 - Concentrated silicone. Lubricant is applied to felt pads in lubricator boxes or placed in reservoir of C061 style lubricator.
- Use on cotton, Dacron, nylon and other synthetic thread or old thread from which the manufacturer's lubricant has evaporated.



Part No.	Description	Size
M301	Lubricant for dipping thread	950ml/1 quart
M305	Lubricant for lubricator	950ml/1 quart

Caution: Thread and material should always be pre-tested before using thread lubricant. Thread lubricants can make coloured thread look darker.

Thread Lubricators

- Lubricator box fixes securely to sewing machine to lubricate thread as you sew.
- Does not require removal from sewing machine for refilling.
- Magnet on base holds lubricator firmly in place.



Part No.	Description	Use With
C061	Lubricator box with felt pads and reservoir	M305

Sewing Machine Oil

- Non staining, clear "white oil" to keep sewing machines lubricated for maximum smoothness and precision sewing.



Part No.	Description	Size
M321	Non-staining white oil (clear)	950ml/1 quart
M322	Non-staining white oil (clear)	3360ml/1 gallon

Oil Bottle

- Application bottle has screw-on cap to prevent accidental spills when bottle is on its side.



Part No.	Description
C063	120ml/4 ounce bottle with long pour tube and cap

Palm & Needles

William Smith Palms - Retail Quality



Part No.	Description	Style	Hand
C023	Lightweight, non adjustable	2	Right
C024	Lightweight, non adjustable	3	Right
C025	Lightweight, non adjustable	3	Left
C026	Lightweight, adjustable	2 1/2	Right
C027	Lightweight, adjustable	2 1/2	Left
C036	Medium weight	9	Right
C037	Medium weight	9	Left

William Smith Palms - Professional Quality



Part No.	Description	Style	Hand
C028	Good quality seaming	11	Right
C029	Good quality seaming	11	Left
C030	Good quality roping	12	Right
C032	Super quality seaming	15	Right
C033	Super quality seaming	15	Left
C034	Super quality roping	16	Right

William Smith Sailmakers Needles

- William Smith's best quality "Green Label" reduced edge.
- Available only in full packs of 25.



Part No.	Size	Length: mm/in	Diameter: mm/in	Pack Qty
C010	10	89 3.504	3.25 0.128	25
C012	12	81 3.189	2.64 0.104	25
C013	13	79 3.110	2.34 0.092	25
C014	14	76 2.992	2.03 0.080	25
C015	15	72 2.835	1.83 0.072	25
C016	16	69 2.717	1.63 0.064	25
C017	17	65 2.559	1.42 0.056	25
C018	18	62 2.441	1.22 0.048	25
C019	19	49 1.929	1.02 0.040	25

Assorted Size Needles

All needles are hand-made and hand polished for ease of use.

- Tubes and packs contain assorted size needles.



Part No.	Description
C005	5 Needles in assorted sizes in packet
C021	10 Needles in assorted sizes in tube
C022	20 Needles in assorted sizes in tube

Sewing Accessories

Pneumatic Upholstery Staplegun

- Ergonomic handle and rubber grip.
- Bottom loading magazine aids speed of reloading.
- Two finger trigger.
- Rear exhaust with muffler.
- Applications: Marine & automotive upholstery, bedding, molding.



Part No.	Description
C754	Heavy Duty Empire Pneumatic Upholstery Staplegun
D744	Stainless Steel #7 Upholstery Staples 1/4"
D748	Stainless Steel #7 Upholstery Staples 3/8"
D742	Stainless Steel #7 Upholstery Staples 1/2"

Awls

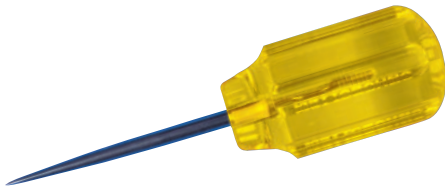

Part No.	Description	Pack Qty
C900	Yellow handle 130mm Long	20
C901	Yellow handle 100mm Long	20

Sewing Awl & Accessories

- Awl comes complete with two straight needles, waxed thread and combination wrench/screwdriver.
- Awl is ideal for sewing and repairs on leather and canvas.
- Standard thread supplied is white.



Part No.	Description
C910	Awl Set
C9105	#5 Fine Straight Needle
C9106	#6 Curved Needle
C9108	#8 Heavy Duty Needle
C911BK	Black Replacement Thread
C911WT	White Replacement Thread

Speedy Stitcher Sewing Awl



Part No.	Description
C916	Speedy Stitcher
C917C8	Curve Needle for Speedy Stitch
C917ST8	Straight Needle #85 For Speedy Stitch
C918/30	Course Polyester Thread 30 Yard

Stapling Pliers

- Special stapling pliers with high raised clincher.
- For stapling around bolt ropes or rolled up material.



Part No.	Description
C758	Raised Clinch Staple Pliers

Staples

- 1 case = 100 boxes of 5000 staples.

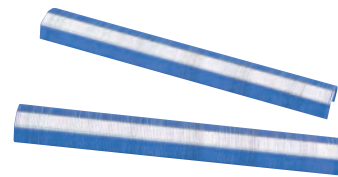

Part No.	For Use With	Length: mm/in	
D724	C756	6.4	1/4
D732	C758	6.4	1/4
D733	C758	9.5	3/4

Staple Remover



Part No.	Description
C519	Metal Push-Type Staple Remover

Cutting & Sealing Tools

Engel Hot Knife

- Designed to cut and seal synthetics, woven and knit fabrics, and cut and weld rope, cord and webbing.
- Quick heating with built in spot lights.
- Combine with optional blades for a variety of uses.
- Engel hot knife is sold without blades - see below for order details.



Part No.	Description	Overall Length: mm/in	Heats To	Volt	Watt
C850	HSGO - EURO	254 10	537°C	220	60

Engel Cutting Attachments

- C852 is a standard blade.
- C853 is ideal for applique work, to cut and seal synthetics.
- C854 holds material down while cutting. Use C852 blade. Does not require special cutting surface.
- C856 - Use C852 blade. Does not require special cutting surface.

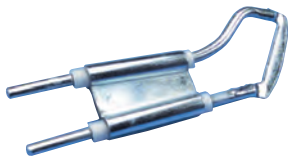

C852

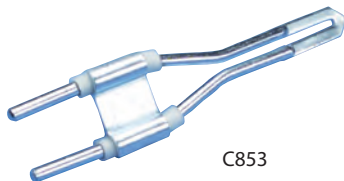

C853



C856



C854

Part No.	Description
C852	Type 100 'R' Standard Blade
C853	Type HSO Precision Blade
C854	Adjustable Base SF Cutting Foot
C856	Standard Cutting Foot

CAUTION

CAUTION

Hot knives are designed for intermittent operation and should not be used for more than 20 minutes at one time without a pause.

Bainbridge Hot Knife

- Designed to cut and seal synthetics, woven & knit fabrics and cut and weld rope, cord and webbing.
- Seals edges with minimum smoke and no singed edges.
- Effortless cutting - no mess, no fuss.
- Spring loaded safety trigger on/off switch.
- Quick heating.



Part No.	Description	Power Cord Length: m	Heats To	Volt	Watt
C857	Without Blade	2.5	537°C	230	60
C85D	With Blade	2.5	537°C	230	60

Bainbridge Cutting Attachments



C857B



C857C

Part No.	Description
C857B	Standard Hot Knife Blades
C857C	Cutting Foot for Bainbridge Hot Knife

Ultratorch Heat Tool

- Industrial strength portable gas heat tool with soldering tip.
- Becomes rugged and transportable hot knife with hot knife replacement tip, C882.
- Self igniting with adjustable power levels.
- Standard tip is a 2.0 mil soldering tip.
- Operates for approximately 3 hours at number 3 setting.
- Heats to 510°C.
- Weighs 5.5oz.
- Overall length 267mm.



Part No.	Description
C880	Ultratorch Heat Tool
C882	Ultratorch Heat Tool Tip

Hot Knives & Scissors

Bench Mount Hot Knife

- Base is flanged with mounting holes for permanent placement, which allows two hands to be free for better control when cutting.
- Unit comes with base and one 2 inch cutting blade.
- Great for quick, clean cuts of rope or webbing.

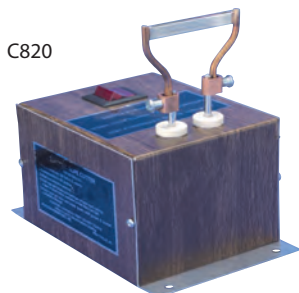

Part No.	Volt	Heats to
C820	110	1200°
C820R	2 inch Replacement Cutting Blade for C820	

Hot Tool

This light weight, easy to hold tool has a heating element which slides inside the selected tip attachment allowing a very efficient use of heat. Tips may be interchanged for cutting, sealing or circle cuts.

- Easy to hold tools with hot knife blade included.
- Heats quickly up to working temperature.
- Heat element of tool fits inside tip for greater efficiency.

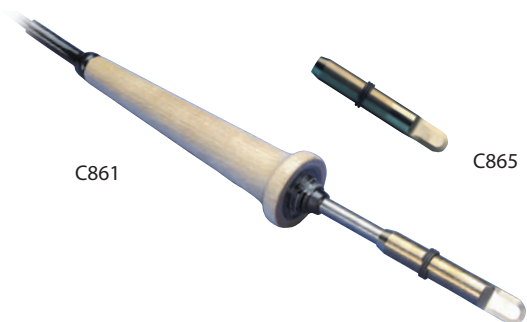

Part No.	Type	Handle Length: mm/in	Overall Length: mm/in	Heats To	Volt	Watt
C860	Light duty	89 3 1/2	152 6	454°C	110	18
C861	Heavy duty	127 5	241 9 1/2	565°C	110	18
C862	Knife Blade for C860					
C865	Knife Blade for C861					

Transformer

- Maximum load is 100W. Output fuse is 1 amp.
- Use with C861 Hot Tool.



Part No.	Description
C807	230V a.c. to 115V a.c.

Portasol Hot Knife Kit

- Totally Portable, four in one kit polypropylene travel case.
- Kit includes:
 - Hot knife with adjustable power levels, hot blow, blow torch, 2.4mil soldering tip, safety stand, built-in ignitor cap.
 - Overall length: 165mm / 6.5 in
 - Weight: 4.5oz.
 - Heats to 400°C.



Part No.	Description
C834	Portasol Hot Knife Kit
C832	Portasol Hot Knife Tip

Fiskars Scissors

- Stainless steel blades with comfortable moulded handles.



Part No.	Type	Length: mm/in
C907	Lightweight/Right hand	215 8.5
C908	Lightweight/Left hand	215 8.5
C909	Sailmakers standard weight	240 9.5

Knife Edge Shears

- One blade is ground to a knife edge for cutting synthetic fibre.

Wiss



Part No.	Wiss #	Length: mm/in
C550-10	1225 Polished	254 10
C550-12	1226 Polished	305 12

Scissors & Shears

Industrial Shears

- Nickel Plated Blades



Part No.	Wiss #	Length: mm/in	
C551-7	27	178	7
C551-8	28	203	8
C551-9	29	229	9

Wiss Heavy Duty Shears

- Polished blades.

Wiss



Part No.	Wiss #	Length: mm/in	
C552-10	20	254	10
C552L-10	20 Left Hand	254	10
C552-12	22	305	12

Extra Heavy Duty Shears

- Polished blades with fully contoured handles.



Part No.	Wiss #	Length: mm/in	
C555-10	20W	254	10
C555-12	22W	305	12

Teflon Coated Shears

- Teflon coated with serrated edge.
- Suggested for cutting Kevlar®.



Part No.	Length: mm/in	
C912	260	10.5

Seam Rippers



Part No.	Description
C905	Small for spinnaker seams
C906	Deluxe quality

Thread Snips

- C554 Plastic with replaceable stainless steel blades.
- C553 Metal with replaceable stainless steel blades
- C910 Fiskars plastic with stainless steel blades.



Part No.	Description
C554	Professional quality thread snips Plastic
C553	Professional quality thread snips Metal
C910	Fiskars thread snips

Fiskars Scissor Tuner

- Maintains precision cutting performance.



Part No.	Description
C561	Scissor sharpener

Benchwork & Finishing Accessories

Push Pins

- Available only in full packs of 100.

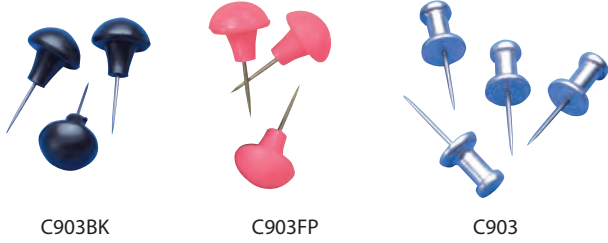

Part No.	Type	Colour	Pack Qty
C903BK	Plastic head	Black	100
C903FP	Plastic head	Hot Pink	100
C903	Aluminium head		100

Cloth Clamps



Part No.	Jaw Opening: mm/in		Overall Length: mm/in	
C515	25	1	102	4
C516	51	2	152	6
C517	76	3	229	9

Sailmakers Leather

- Sailmakers soft chrome leather.
- Waste-free rectangular pieces.

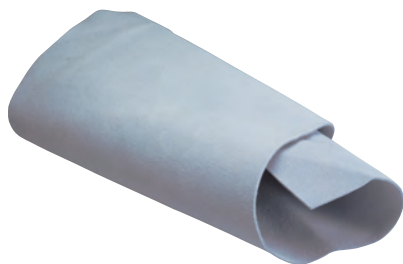

Part No.	Size: mm/in
E160	305 x 610 12 x 24

Maul Master

This revolutionary maul is available in two sizes and offers a dramatic improvement over the old mallet or hammer style.

- Special shock absorbing, no slip rubber grip.
- Special nylon compound striking surface.
- Machined from aircraft aluminium.



Part No.	Weight: kg/lb		Length: mm/in	
C233	1.4	3	229	9
C234	2.0	4.5	254	10

Rawhide Hammer

- Traditional sailmaking tool used with punches, hole cutters, grommet dies and wherever a cushioned hit is desired, now offered in a heavy weight (4lb), larger face style.



C530



C530R

Part No.	Weight: kg/lb		Face Dia: mm/in	
C530	1.2	2 3/4	45	1 3/4
C530R	Replacement Rawhide Faces for C530			
C531	1.8	4	50	2

Hole Punching Tools

Vinyl Cutting Pads

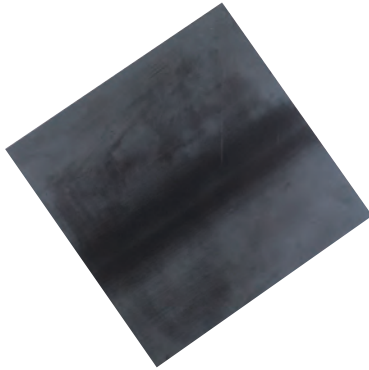

Part No.	Size: mm/in	Colour
C501	250 x 250 x 13 10 x 10 x ½	Black

Hole Punches

- Manufactured to imperial sizes.



Part No.	Size: mm/in
C101	3.2 1/8
C102	4.0 5/32
C103	4.8 3/16
C104	6.3 1/4
C105	7.9 5/16
C106	9.5 3/8
C107	11.1 7/16
C108	12.7 1/2
C109	14.3 9/16
C110	15.9 5/8
C111	17.5 11/16
C112	19.0 3/4
C113	20.6 13/16
C114	22.2 7/8
C116	25.4 1
C117	28.6 1 1/8
C118	31.8 1 1/4
C119	34.9 1 3/8
C120	38.1 1 1/2
C122	44.5 1 3/4

Revolving Hand Punch

- For cover and canvas work.



C125

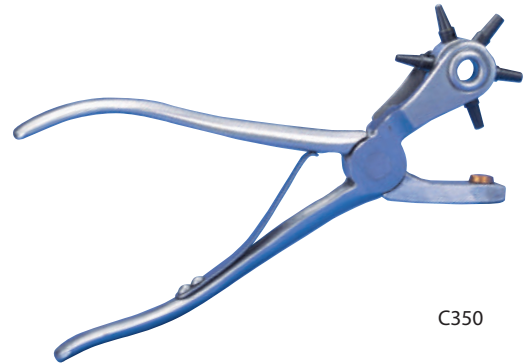

C350

Part No.	Description
C125	Revolving hand punch - 230mm Long
C350	Heavy Duty Revolving hand punch - 230mm Long

Replacement Tubes & Anvil for Revolving Hand Punch

- Carbon steel replacement tubes and copper anvil for C350 punch.



C3500

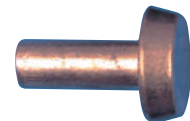

C350A

Part No.	Size: mm/in	Tube Size
C3500	1.9 5/64	0
C3501	2.4 3/32	1
C3502	2.8 7/64	2
C3503	3.2 1/8	3
C3504	4.0 5/32	4
C3505	4.4 11/64	5
C3506	4.8 3/16	6
C350A	Copper Anvil	

Pattern Making & Lofting

Mylar® Pattern Material



Part No.	Style	Roll Length: m/yd		Width: mm/in		Thickness: Microns/in	
E062	Pale blue clear	25	27.3	1350	53.0	175	0.007
K903	Opaque	50	54.7	1000	39.4	350	0.014

Fabrene Pattern Material

Economical, flexible and stable pattern material. The ideal material to make on site patterns for awnings and any type of cover. Especially useful for custom and one-off jobs due to economical price. Can also be used to make bags and accessories.

- Stable yet flexible.
- Economical.
- Can also be used for bags and accessories.



Clear



Navy Blue



Silver/Black

Part No.	Style	Roll Length: m/yd		Width: mm/in	
FP072CL	Clear	200	218	1830	72
FP072NB	Navy Blue	200	218	1830	72
FP072SB	Silver/Black	200	218	1830	72
FP080CL	Clear Pattern	200	218	1830	72

Fibreglass Lofting Battens

- Additional transport charges may be applicable.



Cross section C914/5



Cross section C920/2/4

Part No.	Length: m/ft		Sections: mm/in	
C914	5	16	12 x 9	1/2 x 3/8
C915	10	33	12 x 9	1/2 x 3/8
C920	12.2	40	25 x 8	1 x 5/16
C922	18.3	60	25 x 8	1 x 5/16
C924	30.5	100	25 x 8	1 x 5/16

Kneepads



Part No.	Description	Pack Qty
C904	Rubber pads with hook & loop fastenings	1 Pair

Measuring & Marking

Measuring Tapes

- Impact resistant ABS case with winding handle.
- Double sided 10mm blade: metres x centimetres/millimetres reverse side: feet x 1/8 inches.



Part No.	Description
C705	30m/100ft steel tape

Measuring Tapes

- Impact resistant case.
- C713 Graduated top edge: feet/inches x 1/8 inches bottom edge: metres x centimetres/millimetres.
- C706 Graduated top edge: feet/inches x 1/10 inches bottom edge: metres x centimetres/millimetres.



C713

C706

Part No.	Description
C713	100ft/30m fibreglass
C706	100ft/30m fibreglass

Aluminium Ruler

- Used to make straight edge for drawing or cutting.
- Imperial/ metric.



Part No.	Length: m/ft	Width: mm/in
C710	1 3.28	31.2 1 1/4

Washable Marking Pencils

Ideal for making marks on Solacryl, TopGun or most other fabrics and vinyls.

- Use a moist sponge or damp fabric towel to remove pencil marks.
- Pencils do not contain wax.



ZPENCILBU

ZPENCILWT

Part No.	Colour	Pencils Per Box
ZPENCILWT	White	12
ZPENCILBU	Blue	12

China Marker

Marks on boat top, industrial vinyls, glass, window vinyl, polycarbonate or any polished surface.

- String-pull sharpening.
- Wipes off easily with a damp cloth.



Part No.	Colour	Pencils Per Box
ZMARKERWT	White	12

CAUTION

Note: Always test effectiveness of china markers and washable pencils on a scrap piece of the exact material before use on a new project.

Marking-Out Chalk

- H.Hancock tailors chalk.
- Available only as a full pack.



Part No.	Colour	Pack Qty
C933	White	12

Seam Sealers & Lubricants

Plastiseam – Seam Kote™

- Weather resistant plastic coating to protect seams from abrasion.
- Use on all types of outdoor fabrics: tents/backpacks/awnings/boat tops/sails.
- 60ml/2oz will seal approx. 40m/140ft of seams.



M003



M004

Part No.	Liquid Measure: ml/oz	
M003	355	12
M004	3785	128

Seam Kote™

- Water borne urethane coating which exhibits excellent durability, flexibility and washability.
- Lightfast and UV resistant.
- Abrasion and impact resistant.
- Does not prevent mould or mildew.
- Good adhesion to a variety of substrates.
- Contains no aromatic solvents.
- Fast drying and easy to clean.
- Keep from freezing.



Part No.	Liquid Measure: L/Gal	
M150	3.8	1
M151	18.5	5

ISSO™ - Seam Sealer

- Protects sewn seams.
- Does not change the look or feel of the fabric.



Part No.	Liquid Measure: ml/fl oz	
M216	118	4

Sailkote™ McLube

High performance dry lubricant.

- Clean & Dry: Sailkote is a translucent liquid that sprays or wipes on and completely dries in seconds.
- No oils, silicones or waxes.
- Does not attract dirt.
- Long lasting: bonds to any clean and dry surface.
- Easy to apply: spray, wipe or brush. Spray on a thin, even coating, apply thin second coat to ensure coverage.
- Mask areas you do not want coated.
- Sailkote is extremely slippery.



Part No.	Description	Liquid Measure: ml/floz	
M401	Spray	177	6
M402	Spray	473	16
M403	Quart	946	32
M404	Gallon	3780	128

Teflon® Lubricating Spray

- Use for lubricating dies, closing tools and generally around the loft.
- Synthetic lubricant that out-performs and outlasts petroleum based lubricants.
- Reduces friction and wear.
- Prevents rust and corrosion.
- Contains no CFC's or chlorinated solvents.



Part No.	Liquid Measure	
M005	312ml/11 Fl oz	

303 Fabric Cleaner

303 Fabric Cleaner is a super-concentrated, new technology cleaner. It contains no soap, detergent or solvent and is non-hazardous, non-toxic and non-flammable.

- Super-concentrated and super safe.
- Dilute for spot removing and general cleaning.
- Safely removes even the most difficult stains.
- Rinses residue free.
- Non-hazardous, non-toxic, biodegradable.



Part No.	Description	Liquid Measure: ml/floz	
M020	Trigger spray	946	32

Mildew Remover

- Removes mould, mildew, tough dirt and some stains.
- Use on fabrics, vinyl, plastic, fiberglass and wood.
- Colour and fabric safe.
- Gentle to skin. No harmful vapours.
- Just add water to the biodegradable non toxic, non chlorine powder.
- 1 x 340g jar makes 11 litres of solution.



Part No.	Description
M212	Mildew Remover

Adhesive Remover

A specially blended solvent that provides easy cleanup of most types of adhesive and quickly removes waxes, road tars, grease, oil and similar materials. Will not harm vinyl or fabrics when properly used. Always try on a small area of similar material before use on a sail or cover

- Easy to apply.
- Non-Toxic.
- Non-Allergenic.
- Much safer than acetone.



Part No.	Liquid Measure: ml/oz	
M040	909	32

IMAR Strataglass Protective Cleaner

- Uniquely formulated to clean, shine and protect strataglass and crystal clear 20/20.
- Special UV inhibitors extend the useful life of Strataglass by minimising the deteriorating effects of sunlight.
- Safe for use daily and recommended to use often.
- Pump spray, 118ml / 4fl oz.



Part No.	Description
M2214	IMAR Strataglass Protective Cleaner

IMAR Strataglass Protective Polish

- Uniquely formulated to safely clean, polish and protect strataglass and crystal clear 20/20.
- Creates a nearly invincible protective barrier against the damaging effects of marine environment pollutants.
- Recommended for use every 2-3 months.
- Bottle, 118ml / 4fl oz.



Part No.	Description
M2224	IMAR Strataglass Protective Polish

Protectants & Adhesives

"303" Ultra-Violet Protection

- 303 is excellent for preventative maintenance, with a UV screen that reduces fading and degradation due to ozone, acid rain and weather.
- Non-hazardous and biodegradable. No petrochemicals.
- Not oily or greasy - will not attract dust.
- Use on rubber, plastic, fiberglass, plexiglass, vinyl, leather, canvas and woven polyester fabrics.
- Application: Spray on. Wipe dry. Apply once or twice a year. Apply more often where UV exposure is extreme and constant. 236ml/8floz should cover approximately 13m²/140 square feet.

303



M010



M012

Part No.	Description	Liquid Measure: ml/floz		Pack Qty
M010	Pump Spray	236	8	Each
M012	Gallon Refill	3780	128	Each

3M Super 77 Spray Adhesive

- Securely bonds most lightweight materials.
- Open time is 15-30 minutes, and a long tack time.
- Two spray tips provided.



J959

Part No.	Liquid Measure: ml/floz	
J959	710	24
J959A	500	16.9

"303" High Tech Fabric Guard

303 High Tech Fabric Guard is powerful enough to protect fabrics in the harshest environments outdoors. Yet 303 High Tech Fabric Guard is safe for the finest fabrics, wool, silk and fine leathers.

- Superior performance, coverage and durability
- Soil and stain resistance, to store and maintain water repellence on outdoor fabrics and UV screening.
- Protects against both water and oil based stains. Treated fabrics take longer to soil and clean-up more easily.

Recommended for



303



M013



M016

Part No.	Description	Liquid Measure: ml/floz		Pack Qty
M013	Pump Spray	473	16	Each
M016	Gallon Refill	3780	128	Each

Vinyl Adhesive

- HH-66 vinyl cement is easy to apply, fast drying and a very versatile adhesive for vinyl, plastic, metal, wood and leather.
- Permanently bonds all vinyls.
- Waterproof - repairs leaks in fabrics and may be used as a seam sealer.
- Dries in minutes and remains flexible.



Part No.	Description	Liquid Measure: ml/floz	
J969	Can with brush top	236	8
J970	Can with brush top	473	16
J971	Can with brush top	946	32

Ocean - On Board Repair Kit

- Sturdy zip holdall containing the following:
 - 1 sailmakers palm
 - 1 tube mixed sail needles
 - 5m of 12mm lightweight webbing
 - 5m of 25mm heavyweight webbing
 - 10m of 100mm slit sailcloth
 - 25m of white self-adhesive repair tape
 - 1 roll double-sided tape
 - 1 bench knife
 - 2 awls
 - 1 pair FISKARS stainless steel scissors
 - 2 x 30mm stainless steel rings
 - Thread and whipping twine
 - 2 pencils
 - 20 pushpins.



Part No.	Description
C980	Ocean On Board Repair Kit

Shoreline - Repair Kit

- Sturdy zip holdall containing the following:
 - 1 sailmakers palm
 - 1 tube mixed sail needles
 - 2m of 12mm lightweight webbing
 - 2m of 25mm heavyweight webbing
 - 2m of 100mm slit sailcloth
 - 5m of white self-adhesive repair tape
 - 1 awl
 - Spool waxed thread and spool waxed whipping twine.



Part No.	Description
C981	Shoreline Repair Kit



Repair Kits

General Purpose Bag



Part No.	Description
C989	General Purpose Bag

William Smith Repair Kits



Part No.	Description
C038	Repair kit containing adjustable palm/wax/tube of 10 needles/thread
C038L	Repair kit containing left-handed palm
C039	Repair kit containing lightweight palm/tube of 5 needles/thread



Marine Covers

Solacryl	86
Acrylic Cover Fabrics	88-89
Polyester Cover Fabrics	89-92
Binding & Awning Tapes	93
Awning Tapes & Tracks	94
Awning Hooks & Eyes	95
Boat Top Fittings	96-98
Gemlock Collapsible Strut & Hinge	99
Stainless Steel / Plastic Fittings	100-102
Awning Poles & Accessories	103
Dot® Fasteners	104-105
Fastener Tools	106
Permalock Fasteners	107
Tenax & YKK Fasteners	108

SOLACRYL

Benefits

Solacryl is a high quality range of 100% acrylic fabrics manufactured for Bainbridge International. Designed primarily for use in marine covers,

Solacryl is woven and finished to an exacting specification based on our 30 years experience of supplying fabric to covermakers.

Three styles of Solacryl are available, each specifically designed for different marine applications.



Colour Availability

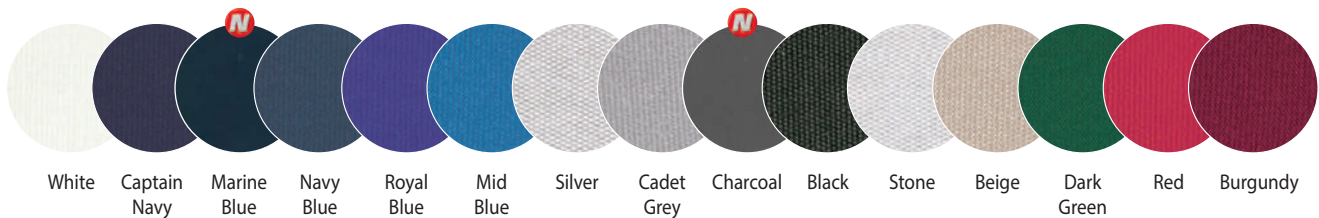

Note: Information correct at time of print. Other colours available against special order. Colour representation from 4-colour process and for reference purposes only. Please inquire for colour sample of actual fabric.

Why Use Solacryl Coated Marine Acrylic?

- Outstanding colour fastness level (7/8).
- 5 year limited warranty.
- Does not fade after sun exposure.
- Withstands the harshest weather conditions.
- Rot-proof.
- Can block up to 90% of UV rays.
- Dirt and oil repellent.
- Mildew resistant
- Antibacterial.
- Superior water resistance due to double coating (fluoro carbon both sides, acrylic resin one side).
- Combines being waterproof with stability.

Caring For a Solacryl Cover

Solacryl marine acrylics have been specifically designed for use in marine covers and awnings and will provide many years of service and protection to your boat. Following these simple guidelines will prolong their appearance.

For regular care and maintenance, excessive dirt should be brushed from the fabric using a soft brush.

The fabric should then be sprayed with warm water (not exceeding 100°F / 40°C) and air dried.

Periodically, the fabric should undergo a more thorough cleaning: Again, brush with a soft bristled brush, spray with warm water then apply a gentle non-detergent soap. Leave to stand for 10 to 20 minutes, allowing the fabric to dry. Rinse thoroughly and air dry. Do not use detergents.

Product Specification Table

Product	Minimum Hydrostatic Head: mm/in		UV Fastness (Max 8)	Oil Repellancy (Max 6)
Solacryl 200	-		8	5
Solacryl Uncoated	300	12	8	5
Solacryl Coated	1000	39	8	5



Do not use detergents or chlorine solutions as these can damage the water repellent coatings.

Do not iron, tumble dry or subject material to extreme heat.

Other colours are available against special order. All special order items are subject to minimum order quantities and additional lead times. Prices on application.



Solacryl 200

This ultra-light style is intended for use by sailmakers as sacrificial UV strips on furling genoas. However, it is also used for upholstery, cushion covers, sun awnings, bags and very light covers.

Part No	Description	Weight: gsm / oz/yd ²		Width: mm/in		Roll Length: m/yds		Colour
F81500100	Ultra light acrylic	195	5.8	1400	55	60	65	White
F81500220	Ultra light acrylic	195	5.8	1400	55	60	65	Royal Blue

Solacryl Uncoated

Solacryl Uncoated is ideal for applications such as sail, winch and binnacle covers where leakage from puddling is unlikely but trapped damp could cause mildew and corrosion. It is recommended for use when shade is a priority over water resistance. It is also ideal for wooden boats and boats that are self draining where a damp atmosphere will cause damage yet water in the boat will drain or evaporate quickly and for sun shades.

Part No	Description	Weight: gsm / oz/yd ²		Width: mm/in		Roll Length: m/yds		Colour
F83500100	Uncoated acrylic	305	9	1520	60	60	65	White
F83500206	Uncoated acrylic	305	9	1520	60	60	65	Captain Navy
F83500207	Uncoated acrylic	305	9	1520	60	60	65	Marine Blue
F83500210	Uncoated acrylic	305	9	1520	60	60	65	Navy Blue
F83500220	Uncoated acrylic	305	9	1520	60	60	65	Royal Blue
F83500230	Uncoated acrylic	305	9	1520	60	60	65	Mid Blue
F83500300	Uncoated acrylic	305	9	1520	60	60	65	Silver
F83500400	Uncoated acrylic	305	9	1520	60	60	65	Cadey Grey
F83500402	Uncoated acrylic	305	9	1520	60	60	65	Charcoal Grey
F83500450	Uncoated acrylic	305	9	1520	60	60	65	Black
F83500500	Uncoated acrylic	305	9	1520	60	60	65	Stone
F83500600	Uncoated acrylic	305	9	1520	60	60	65	Beige
F83500700	Uncoated acrylic	305	9	1520	60	60	65	Dark Green
F83500800	Uncoated acrylic	305	9	1520	60	60	65	Red
F83500910	Uncoated acrylic	305	9	1520	60	60	65	Burgundy

Solacryl Coated

Solacryl Coated features a heavier acrylic coating to increase the hydrostatic head to over 1000mm. This coating on the underside does not affect the appearance or feel of the fabric outside, making for a cover that is almost 100% waterproof, yet retains the appearance and quality of a traditional cover. Ideal for when water resistance is a priority.

Solacryl Coated is the most popular style in the range as it is ideal for most marine applications including sprayhoods, cockpit covers.

Part No	Description	Weight: gsm / oz/yd ²		Width: mm/in		Roll Length: m/yds		Colour
F84500100	Coated acrylic	345	10.2	1520	60	60	65	White
F84500206	Coated acrylic	345	10.2	1520	60	60	65	Captain Navy
F84500207	Coated acrylic	345	10.2	1520	60	60	65	Marine Blue
F84500210	Coated acrylic	345	10.2	1520	60	60	65	Navy Blue
F84500220	Coated acrylic	345	10.2	1520	60	60	65	Royal Blue
F84500230	Coated acrylic	345	10.2	1520	60	60	65	Mid Blue
F84500300	Coated acrylic	345	10.2	1520	60	60	65	Silver
F84500401	Coated acrylic	345	10.2	1520	60	60	65	Cadet Grey
F84500206	Coated acrylic	345	10.2	1520	60	60	65	Charcoal Grey
F84500450	Coated acrylic	345	10.2	1520	60	60	65	Black
F84500500	Coated acrylic	345	10.2	1520	60	60	65	Stone
F84500600	Coated acrylic	345	10.2	1520	60	60	65	Beige
F84500700	Coated acrylic	345	10.2	1520	60	60	65	Dark Green
F84500800	Coated acrylic	345	10.2	1520	60	60	65	Red
F84500910	Coated acrylic	345	10.2	1520	60	60	65	Burgundy

Acrylic Cover Materials

Sunbrella® - Made in USA

- 100% solution dyed woven fabrics in 1170mm/46 inch, 1520mm/60inch and 2300/80inch widths.
- Excellent fade and weather resistance, durable, UV resistant.
- Colourfast, water repellent, mildew and stain resistant.
- Fabric is covered by 10 year limited warranty.
- Average roll length: 59m/194ft.
- Weight: 305gsm/9 oz sq yd.



Sunbrella® Supreme

- 100% solution dyed acrylic.
- Soft acrylic flocking layer on reverse.
- Excellent water resistance.
- Width: 1520mm/60inches.
- Weight: Approx 440gsm/13 oz sq yd.



Firesist 3

- Fire-retardant product woven from high UV and fade resistant, solution dyed fibre & backed with a durable urethane/acrylic coating.
- Meets NFPA701-99, test method II fire retardant specifications.
- Meets many other fire codes for exterior and interior fabric use.
- Weight: Approx. 297 gsm/8.75oz sq yd.
- Very colorfast - colour is locked into fibre.
- Excellent mildew resistance.
- Width: 1520mm / 60".



Part No.	Description
FS82000	Firesist 3 Regatta
FS82002	Firesist 3 Forest Green Tweed
FS82003	Firesist 3 Forest Green
FS82005	Firesist 3 Regatta Tweed
FS82006	Firesist 3 Sand
FS82008	Firesist 3 Black
FS82010	Firesist 3 Admiral Navy
FS82012	Firesist 3 Toasty Beige
FS82013	Firesist 3 Sunburst Yellow
FS82015	Firesist 3 Ivory
FS82016	Firesist 3 Burgundy
FS82017	Firesist 3 Crimson Red

All colours are available against special order. Please enquire for full details and prices.



Acrylic & Polyester Cover Fabrics

SeaMark Marine Fabric



- Best of both worlds - a beautiful colour fast fabric with the added durability of vinyl.
- Sunbrella woven acrylic on the top side for UV durability and vibrant colour.
- Marine grade vinyl with textured embossing on the bottom side to colour match the acrylic.
- Waterproof.
- Abrasion resistant on vinyl side.
- Weight: 509gsm/15oz/sq yd.

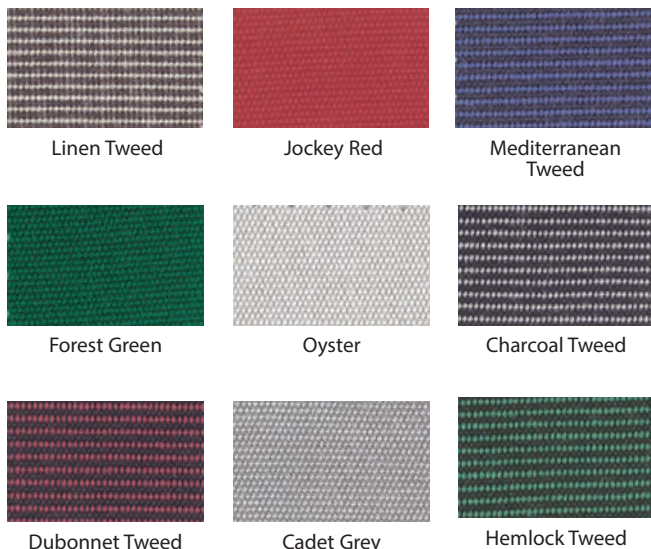

Part No.	Colour	Width: mm/in	Av Roll Length: m/yd
F0400A09Y	Linen Tweed	1570 62	45.7 50
F0400A10Y	Jockey Red	1570 62	45.7 50
F0400A17Y	Mediterranean Tweed	1570 62	45.7 50
F0400A37Y	Forest Green	1570 62	45.7 50
F0400A42Y	Oyster	1570 62	45.7 50
F0400A82Y	Hemlock Tweed	1570 62	45.7 50
F0400A96Y	Dubonnet Tweed	1570 62	45.7 50
F0400A97Y	Cadet Grey	1570 62	45.7 50
F0400A98Y	Charcoal Tweed	1570 62	45.7 50

Sola-Vinyl 350

- Produced specifically for the marine market.
- Fine finish to enhance appearance.
- Polyester base fabric for low shrink.
- UV stabilised.
- Fungicide treated.
- Weight: 350gsm/10.3 oz yd²

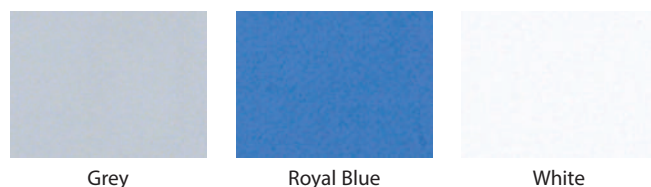

Part No.	Colour	Width: mm/in	Av. Roll Length: m/yd
FH350GY	Grey	1500 59	50 55
FH350RB	Royal Blue	1500 59	50 55
FH350WT	White	1500 59	50 55

Top Gun Polyester Cover Cloth

TOP GUN

- Polyester duck base fabric with a specially formulated polymeric coating that will not harden, crack or peel after outdoor exposure or when subjected to temperatures below 0°F.
- Super high strength with great abrasion resistance.
- Stable fabric with maximum stretch or shrinkage less than 1%.
- UV and mildew resistant.
- Water repellent, permeable to water vapour but will not trap excess moisture.
- 5 year manufacturers limited warranty.
- Weight: 373gsm /11oz sq yd.



Part No.	Colour	Width: mm/in	Av Roll Length: m/yd
F0300A18Y	Caribbean Blue	1570 62	45.7 50
F0300A97Y	Seagull Gray	1570 62	45.7 50
F0300A22Y	Navy Blue	1570 62	45.7 50
F0300A46Y	Forest Green	1570 62	45.7 50
F0300A89Y	Aquamarine	1570 62	45.7 50
F0300A60Y	Black	1570 62	45.7 50
F0300A14Y	Indian Birch	1570 62	45.7 50
F0300A00Y	Arctic White	1570 62	45.7 50
F0300A44Y	Teal	1570 62	45.7 50
F0300A75Y	Burgundy	1570 62	45.7 50
F0300A10Y	Sunset Red	1570 62	45.7 50
F0300A67Y	Hemp Beige	1570 62	45.7 50
F0300A74Y	Buckskin Tan	1570 62	45.7 50
F0300A90Y	Harbour Blue	1570 62	45.7 50
F0300A98Y	Charcoal Gray	1570 62	45.7 50
F0300A66Y	Sand	1570 62	45.7 50
F0300A79Y	Royal Blue	1570 62	45.7 50
F0300A85Y	Turquoise	1570 62	45.7 50
F0300A65Y	Taupe	1570 62	45.7 50
F0300A68Y	Chocolate Brown	1570 62	45.7 50

Polyester Cover Fabrics

Holiday Flame Retardant Fabric

HOLIDAY



- A high performance 100% Polyester awning fabric - acrylic coated.
- Super high strength with great abrasion resistance.
- Dimensionally stable fabric with maximum stretch or shrinkage of less than 1%.
- UV and mildew resistant.
- Water repellent, permeable to water vapour but will not trap excess moisture.
- 5 year manufacturers limited warranty.
- Meets USA CA State Fire Marshall 117e, NFPA 701, CPAI-84 and ASTM_E84-84 codes.
- Weight: 407gsm/12oz sq yd.



Part No.	Color	Width: mm/in		Av Roll Length: m/yd	
F0350A75Y	Burgundy	1570	62	45.7	50
F0350A60Y	Black	1570	62	45.7	50
F0350A97Y	Silver Grey	1570	62	45.7	50
F0350A47Y	Hunter Green	1570	62	45.7	50
F0350A13Y	Ivory	1570	62	45.7	50
F0350A79Y	Royal Blue	1570	62	45.7	50
F0350A00Y	White	1570	62	45.7	50



Odyssey Polyester Cover Cloth

ODYSSEY

- Impregnation coated, 100% woven polyester suitable for many indoor or outdoor applications.
- Mildew and UV resistant.
- Superior water and stain resistance.
- Very low shrink or stretch.
- Breathable.
- Uses: Cots, boat covers, canopies, bags and miscellaneous covers.
- Weight: 220gsm/6.5 oz yd².
- Cut lengths available: minimum 5m.



Part No.	Colour	Width: mm/in		Av Roll Length: m/yd	
F0800A18Y	Caribbean Blue	1630	64	45.7	50
F0800A88Y	Silver Grey	1630	64	45.7	50
F0800A79Y	Royal Blue	1630	64	45.7	50
F0800A00Y	White	1630	64	45.7	50
F0800A10Y	Red	1630	64	45.7	50
F0800A14Y	Birch	1630	64	45.7	50
F0800A44Y	Teal	1630	64	45.7	50
F0800A46Y	Forest Green	1630	64	45.7	50
F0800A60Y	Black	1630	64	45.7	50
F0800A75Y	Burgundy	1630	64	45.7	50
F0800A65Y	Taupe	1630	64	45.7	50
F0800A90Y	Harbour Blue	1630	64	45.7	50
F0800A20Y	Lakeside Blue	1630	64	45.7	50
F0800A97Y	Charcoal Grey	1630	64	45.7	50

Note: Information correct at time of print. Other colours available against special order. Colour representation from 4-colour process and for reference purposes only. Please inquire for colour sample of actual fabric.

Polyester Cover Fabrics

Soft Touch by Odyssey



- 100% woven polyester Odyssey with a light weight, non-woven, soft fuzzy polyester backing.
- Abrasion resistant.
- Weatherproof.
- Backing provides excellent gel-coat or varnish protection.
- Uses: Boat & trailer covers.
- 405gsm/12.5oz/sq yd.

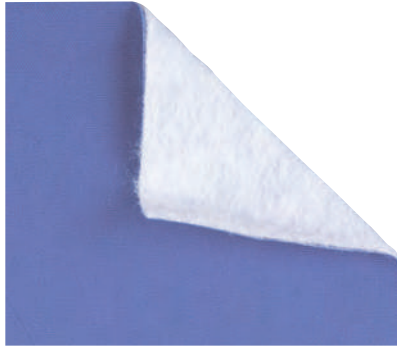

Part No.	Colour	Width: mm/in	Av Roll Length: m/yd
F0805A18Y	Caribbean Blue	1520 60	45.7 50
F0805A88Y	Grey	1520 60	45.7 50
F0805A60Y	Black	1520 60	45.7 50
F0805A00Y	White	1520 60	45.7 50

Odyssey with PSA Backing



- Impregnation coated, 100% woven polyester suitable for many indoor and outdoor applications.
- Mildew and UV resistant.
- Superior water and stain resistance.
- Very low shrink or stretch.
- Pressure sensitive adhesive.
- Uses: Boat cover repairs, reinforcement, roller furling cover.



Caribbean Blue

Silver Grey

Harbour Blue



White

Royal Blue

Charcoal Grey

Part No.	Colour	Width: mm/in	Av Roll Length: m/yd
F0808Z79Y	Caribbean Blue	1630 64	68.6 75
F0808Z88Y	Silver Grey	1630 64	68.6 75
F0808Z18Y	Harbour Blue	1630 64	68.6 75
F0808Z00Y	White	1630 64	68.6 75
F0808Z90Y	Royal Blue	1630 64	68.6 75
F0808Z97Y	Charcoal Grey	1630 64	68.6 75

Top Notch - Solution Dyed Polyester

- Solution dyed 840 denier polyester.
- Colourfast and UV resistant.
- Dimensionally stable.
- Exceptional tear strength.
- Durable and abrasion resistant finish.
- Fluorocarbon finish for excellent water repellancy.
- 5 year warranty.
- Weight: 373gsm/11.0oz sq yd.



Forest Green

Charcoal

Burgundy



Black

Sea Gull Grey

Blue



Ocean Blue

Navy

Tan

Part No.	Colour	Width: mm/in	Length: m/yd
F0200A10Y	Red	1520 60	45.7 50
F0200A46Y	Forest Green	1520 60	45.7 50
F0200A60Y	Black	1520 60	45.7 50
F0200A97Y	Sea Gull Grey	1520 60	45.7 50
F0200A18Y	Blue	1520 60	45.7 50
F0200A22Y	Ocean Blue	1520 60	45.7 50
F0200A23Y	Navy	1520 60	45.7 50
F0200A35Y	Yellow	1520 60	45.7 50
F0200A65Y	Taupe	1520 60	45.7 50
F0200A67Y	Tan	1520 60	45.7 50
F0200A75Y	Burgundy	1520 60	45.7 50
F0200A98Y	Charcoal	1520 60	45.7 50

Note: Information correct at time of print. Other colours available against special order. Colour representation from 4-colour process and for reference purposes only. Please inquire for colour sample of actual fabric.

Polyester Cover Fabrics

Nautiplus Marine Cover Fabric

Designed for all marine exterior covers, spray hoods, bimini tops, cockpit covers and winter covers. The high tenacity polyester base fabric is double coated with high quality P.V.C to resist fading in all marine conditions.

Nautiplus is 100% waterproof and dimensionally stable. Backed with a 5- year warranty against rot, mildew and discolouration in normal atmospheric conditions.

- Light fastness - UV stabilised to prevent colours from fading.
- Antimicrobial - Mould and mildew resistant.
- Special silicone finishing formula for easy cleaning.
- Weight: 360g/m²
- 5 Year limited warranty.



Snow White



Off White

Part No.	Colour	Width: mm/in		Av. Roll Length: m/yd	
F87500100	Snow White	2200	86.6	50	55
F87500101	Off White	2200	86.6	50	55



Nautimar Marine Cover Fabric

Made out of high tenacity polyester, woven, PVC coated and embossed one side. A lightweight product, easy to store, totally waterproof.

Nautiplus is the ideal solution for cockpit covers, protective covers and biminis.

- Light fastness - UV stabilised to prevent colours from fading.
- Antimicrobial - Mould and mildew resistant.
- Special silicone finishing formula for easy cleaning.
- Weight: 300g/m²
- 5 Year limited warranty.



Snow White



Ivory



Navy

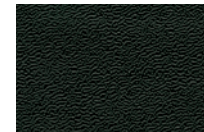

Black

Part No.	Colour	Width: mm/in		Av Roll Length: m/yd	
F86500100	Snow White	2200	86.6	50	55
F86500102	Ivory	2200	86.6	50	55
F86500210	Navy	2200	86.6	50	55
F86500450	Black	2200	86.6	50	55



Note: Information correct at time of print. Other colours available against special order. Colour representation from 4-colour process and for reference purposes only. Please inquire for colour sample of actual fabric.

Binding & Awning Tapes

Centre Fold Acrylic Binding Tape

- Woven acrylic binding tape with a naturally folding centre, finished to 22mm/ 7/8 inch width.
- Binding for sail covers, cushions, tents, canopies, dodgers and biminis.
- Woven with Sunbrella acrylic yarns.
- Only sold in full rolls.



Part No.	Colour	Width: mm/in	Roll Length: m/yd
E095BI	Beige	22.2 7/8	183 200
E095BU	Pacific Blue	22.2 7/8	183 200
E095BG	Burgundy	22.2 7/8	183 200
E095BK	Black	22.2 7/8	183 200
E095PG	Persian Green	22.2 7/8	183 200
E095GY	Grey	22.2 7/8	183 200
E095WT	White	22.2 7/8	183 200
E095NV	Navy Blue	22.2 7/8	183 200
E095FGR	Forest Green	22.2 7/8	183 200
E095RD	Jockey Red	22.2 7/8	183 200
E097NV	Navy	25 1	91 100
E097OY	Oyster	25 1	91 100
E097SR	Silver	25 1	91 100

Acrylic Binding Tape

- Softly woven binding tape to conform around corners nicely. Finished to 19mm/ 3/4 inch width.
- Binding for sail covers, cushions, tents and canopies.
- Woven with Sunbrella acrylic yarns.
- Only sold in full rolls.



Part No.	Colour	Width: mm/in	Roll Length: m/yd
E090BU	Pacific Blue	19 3/4	91 100
E090BK	Black	19 3/4	91 100
E090WT	White	19 3/4	91 100

Stamoid® Vinyl Double Fold Bias Binding Tape

- Premium quality Stamoid vinyl is double folded into 19mm/ 3/4 inch and 25mm/ 1 inch bias binding tape. Stamoid vinyl has outstanding UV resistance, is dirt repellent and washable and is waterproof and treated against mildew.
- Matching binding is used with Stamoid to trim or bind cushions, canopies, dodgers and biminis etc.
- Binding is sold in full reels only.



STAMOID

Part No.	Colour	Width: mm/in	Roll Length: m/yd
E085WT	White	20 3/4	91 100
E085BK	Black	20 3/4	91 100
E085IV	Ivory	20 3/4	91 100
E085CR	Cream	20 3/4	91 100
E085SD	Sand	20 3/4	91 100
E085SW	Snow White	20 3/4	91 100

Awning Tapes

- Available on full rolls only.

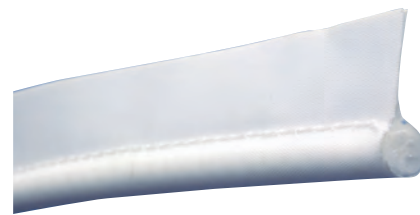

Part No.	Roll Length: m/yd	Cord: mm/in	Colour
LS001	80-100 90-110	7 0.3	White
LS002	80-100 90-110	6 0.25	White

Plastic Piping Cord

- Plastic cord for piping spray hoods.



Part No.	Thickness: mm/in	Roll Size: m/ft
E491	4 0.16	305 1000
E492	5 0.20	305 1000
E493	6 0.24	305 1000
E494	7 0.28	305 1000

Note: Information correct at time of print. Other colours available against special order. Colour representation from 4-colour process and for reference purposes only. Please inquire for colour sample of actual fabric.

Awning Tapes & Tracks

Keder

- Durable woven polyester easily slides into vinyl or plastic mouldings.
- Can be RF welded.
- Single tongue: L575, L585.
- Double tongue: L575T.
- Reel length: 100m/330ft.
- Cut lengths will be surcharged.
- Available only on full rolls.
- Available in black and white. White shown.

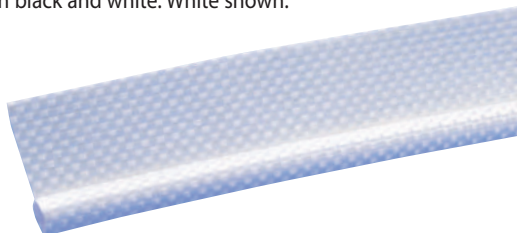

Part No.	Diameter: mm/in	Tape Width: mm/in	Use With	Colour
L575	7.5 1 ¹ / ₂ "	20 3 ⁴ / ₄ "	(510	White
L575T	7.5 1 ¹ / ₂ "	25 1	(510	White
L585	8.5 1 ¹ / ₂ "	20 3 ⁴ / ₄ "	(520	White
L575BK	7.5 1 ¹ / ₂ "	25 1	(510	Black
L585BK	8.5 1 ¹ / ₂ "	20 3 ⁴ / ₄ "	(520	Black

Heavy Duty Plastic Track

- UV Stabilized PVC extrusion.
- Use for awning cords LS001 and L585.

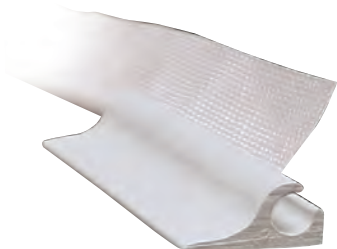

Part No.	Description	Length m/ft
G530	Plastic Track	4.85 16

Cover Trax System

Unique new low profile awning rail system with dacron awning rope and sliding screw cover panel to hide attaching screws.

- Premium grade extruded PVC with UV inhibitors.
- Sleek and ultra low profile.
- Can conform to many contours with use of controlled heat from hair dryer or heat gun.
- Cover Trax can be used for mounting enclosures, curtains and other panels.
- Use with L555 Keder Tape. Enquire for details.



Part No.	Description	Length: mm/in
G535WT/95	White Cover Trax System Includes Awning Track and Screw Cover Panel	2400 95

Heavy Duty Centre Mount Track

- Increased PVC profile allows extra load capability for large covers, bimini and track to track enclosures.
- Can be heat formed to most radius.
- Large channel opening allows use of large Stainless Steel No.6 oval head screws for more secure attachment.
- Deeper screw trough base design allows for use of L585 8.5mm Keder with sufficient clearance of screw heads.

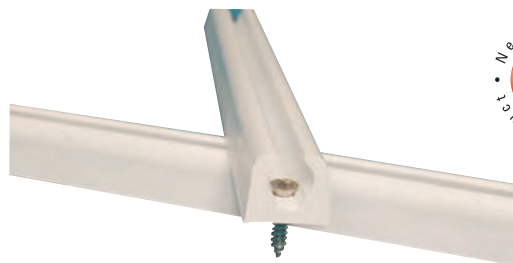

Part No.	Description	Length: mm/ft
G515WT/24	White HD Centre Mount Track	7275 24
G517WT	White HD Concave Centre Mount Track	4850 15

Flex-A-Rail Awning Track

- Flexible, non-corrosive, extruded PVC track for BI awning ropes.
- Works best with L575/LS001/LS002.
- Highly flexible for easy installation.
- Use flat or oval head screws to install (D355/D356).
- Use 3M VHB tape to help install Flex-A-Rail.



Part No.	Colour	Internal Diameter: mm/in	Track Length: mm/ft
G512	White PVC	8 5 ¹ / ₁₆ "	2300 7'6"
G512BK	Black PVC	8 5 ¹ / ₁₆ "	2300 7'6"

Flex-a-Rail Screws

- Screws are sold in full packs only.
- Use to attach Flex-A-Rail and aluminium awning track.
- D371 requires a square head screwdriver.

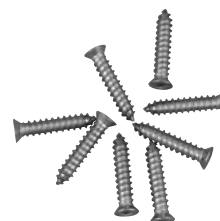

D371

Part No.	Description	Pack Qty
D355	SS No 6 x 20mm/ 3 ⁴ / ₄ inch Flat Head	100
D356	SS No 6 x 20mm/ 3 ⁴ / ₄ inch Flat Head	100
D371	SS No 4 head with No 6 body x 12.5mm/ 1/2 inch	100

Awning Hooks & Eyes

Aluminium Awning Track

- Compatible with most Bainbridge awning ropes and Keder tracks.
- Use pan head screws to install.
- Use with L585 Keder Tape.



Part No.	Colour	Internal Diameter: mm/in	Track Length: mm/ft
G520-8	Anodised Aluminium	9 $\frac{3}{8}$	2425 8

Keder Track Slide

- Allows quick and easy installation to many awning tracks.
- Designed to suit both aluminium and vinyl track (not Flex-a-Rail).
- Potentially removes the need for awning ropes.
- Ideal for making curtains that open and close.



Part No.	Colour	Pack Qty
A091WT	White	100

Square Head Screwdriver

- Use with D371 square head screws.
- Narrow shaft will NOT scratch Flex-a-Rail.



Part No.	Description
C335	Size 0 Square Head Screwdriver

Lacing Buttons



Part No.	Cord Dia: mm/in	Knob Dia: mm/in	Colour	Pack Qty
G045BK	5 $\frac{3}{16}$	18 $\frac{11}{16}$	Black	50
G045WT	5 $\frac{3}{16}$	18 $\frac{11}{16}$	White	50

Rivet-on Cover Hook - Plastic

- Injection moulded in nylon.
- Use D337 rivets.
- Suitable for max 6mm shockcord.



Part No.	Colour	Pack Qty
A071	White	100

Wire Cover Hook

- Available manufactured from brass or stainless steel wire.
- Hand sew or use speedy rivets and backplates.
- Suitable for max 10mm shockcord.



Part No.	Finish	Pack Qty
B401S	Stainless Steel	100

Sew-on Cover Hooks & Eyelets - Plastic

- Injection moulded in nylon.
- Sew through plastic with straight stitch sewing machine.
- Can be used alone, or together.



A068WT



A069WT

Part No.	Description	Colour	Pack Qty
A069BK	Hook	Black	100
A069WT	Hook	White	100
A068BK	Eyelet	Black	100
A068WT	Eyelet	White	100

Speedy Rivets

- Use with B401 Hooks.
- Tap the two parts together with a hammer until they connect firmly.
- Available only in full packs of 100.



Part No.	Finish	Pack Qty
D050N	Nickel Plated	100 Sets

Boat Top Fittings

Sister Clips - Plastic & Stainless Steel

- Durable sister clips for drawstrings and ties.



Part No.	Description	Pack Qty
B606	Nylon Sister Clips	5 Pairs
 B605	Stainless Steel Sister Clips	1

Dodger Hank

- Allow quick and easy attachment on dodgers to guard rails.
- Smarter than lacing.

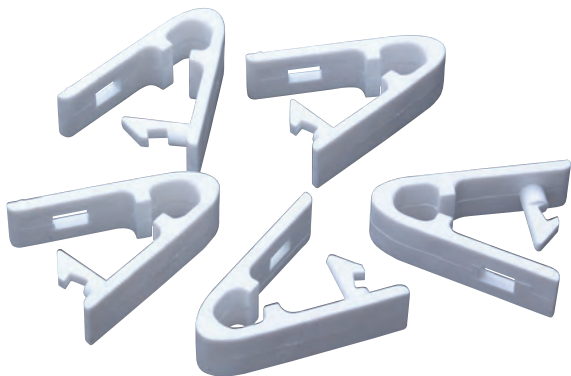

Part No.	Wire Size: mm/in	Grommet Size	Colour	Pack Qty
A036	6 1/4	0 to 5	White	10

Shock Cord Cover Clip

- Used with a lacing knob or other cord cover clip for a fast and simple tie-down.
- Does not require tool to set.
- Now easier attaching system.



G040WT



G040BK

Part No.	Overall Length: mm/in	Colour	Pack Qty
G040BK	86 3 3/8	Black	50
G040WT	86 3 3/8	White	50

Deck Hinge Fittings - Screw Pin

- Die cast type 316 stainless steel.
- Mirror polished finish.

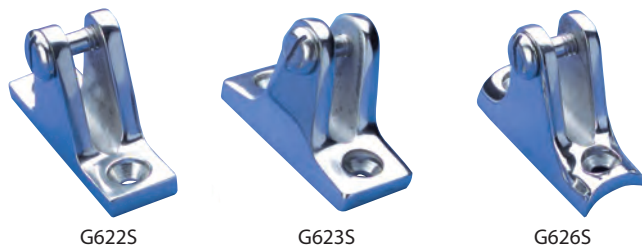

Part No.	Description
G622S	Flat fitting with screw pin
G623S	Angle fitting with screw pin
G626S	Concave fitting with screw pin

Deck Hinge Fittings - Removable Pin

- Die cast type 316 stainless steel.
- Mirror polished finish.



Part No.	Description
G628SQP	Angle fitting with quick release pin
G625S	Flat fitting with removable drop nose pin
G625SQP	Flat fitting with quick release pin
G627PIN	Replacement drop nose pin for G625S
G625PIN	Replacement quick release pin for G625SQP

Lanyard

- Lanyard is used to attach quick release pin to the deck hinge to prevent accidental loss.



Part No.	Description	Length: mm/inch
G625LAN	Stainless steel wire	155 6 1/2

HD Folding Deck Hinge

- Hinge system compensates for different angles of deck and coamings without the need for wedges.
- Folds flat when canopy is removed preventing snagging and injury.
- Manufactured from type 316 stainless steel.
- Use with G611S, G621S, G631S and G641S.



Part No.	Description
G607S	HD Folding Deck Hinge

Boat Top Fittings

Quick Release Deck Mount

- Spring-loaded release button ejects eye end for almost instant frame removal.
- Stylish and unique design.
- Manufactured from type 316 stainless steel.
- Use with G611S, G621S, G631S and G641S.

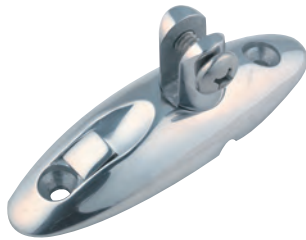

Part No.	Description
G605S	Quick Release Deck Mount

HD Quick Release Deck Mount

- Spring-loaded release button ejects eye end for almost instant frame removal.
- Stylish and unique design.
- Manufactured from type 316 stainless steel.
- Use with G611S, G621S, G631S and G641S.



Part No.	Description
G604S	HD Quick Release Deck Mount

Side Mount Fitting

- Die cast type 316 stainless steel.
- Mirror polished finish.
- Accepts all sizes of eye end.



G624S



G629S

Part No.	Description
G624S	4 hole side mount
G629S	2 hole side mount

Universal Flat Deck Hinge

- Die cast type 316 stainless steel.
- Deck hinge swivels 180°.



Part No.	Description
G607S	Flat Universal Deck Hinge

Frame Tube Hinge with Quick Release Pin

- Heavy duty design and construction.
- Allows frame folding.
- Quick release locking pin.
- Manufactured from 316 stainless steel.



G747S

Part No.	Description	Tube Size: mm/inch
G744S	Heavy Duty Stainless Steel Tube Hinge	25 1
G747S	Heavy Duty Stainless Steel Tube Hinge	22 7/8

Ball Swivel with Quick Release Deck Mount & Eye End

- Manufactured from 316 stainless steel.
- Greater range of motion.
- Base screws to the deck.
- Removing quick pin allows hinge to slide off the base.
- Double set screws.



G731S

G771S

Part No.	Description
G770S	22mm/7/8" Ball Swivel Jaw Slide
G771S	22mm/7/8" Ball Swivel Deck Hinge
G730S	25mm/1" Ball Swivel Jaw Slide
G731S	25mm/1" Ball Swivel Deck Hinge

Boat Top Fittings

Eye Ends

- Die cast type 316 stainless steel.
- Mirror polished finish.



G611S



G621S



G631SHD



G641SHD

Part No.	Description
G611S	Eye End for 19mm/ $\frac{3}{4}$ " Tube
G621S	Eye End for 22mm/ $\frac{7}{8}$ " Tube
G631SHD	Heavy Duty Eye End for 25mm/ 1" Tube with 2 Set Screws
G641SHD	Heavy Duty Eye End for 32mm/ 1 $\frac{1}{4}$ " Tube with 2 Set Screws



Jaw Slides

- Die cast type 316 stainless steel.
- Mirror polished finish.



G610S



G620S



G630SHD



G640SHD

Part No.	Description
G610S	Jaw Slide for 19mm/ $\frac{3}{4}$ " Tube
G620S	Jaw Slide for 22mm/ $\frac{7}{8}$ " Tube
G630SHD	Heavy Duty Eye End for 25mm/ 1" Tube with 2 Set Screws
G640SHD	Heavy Duty Eye End for 32mm/ 1 $\frac{1}{4}$ " Tube with 2 Set Screws



Split Jawslide/Rail Fitting

Mounts without the need to disassemble the rail. Ideal for use on rails that are welded together. Simply slide the two halves together on either side of the rail and they interlock. The fitting fastens easily with a single nut and bolt to the rail in the exact position you desire.

- Package consists of one rail fitting (2 halves) and a stainless steel screw and nut.
- Type 316 stainless steel.
- Order G625PIN or G627PIN to connect eye end.



Part No.	For Use With Tube Size
G820S	22mm/ $\frac{7}{8}$ inch outside diameter
G830S	25mm/ 1 inch outside diameter
G840S	31mm/ 1 $\frac{1}{4}$ inch outside diameter

Universal Deck Hinges

Universal deck hinge compensates for different angles of decks and coamings. Made from mirror polished stainless steel, even vertical surfaces can be accommodated. Available with a screw or quick release pin for easy removal.

- Die cast type 316 stainless steel.
- Mirror polished finish.
- Accepts all sizes of eye end.
- Compensates for different deck and coaming angles including vertical surfaces.
- Available with screw or quick release pin.



Part No.	Description
G615S	Universal deck hinge with screw
G615SQP	Universal deck hinge with quick release pin

Gemlock Collapsible Strut & Hinge



Open



Closed



Gemlock Pre-Made Strut with Hinge

- Completely assembled struts with stainless steel hinges, either 22mm/ 7/8 inch or 25mm/1 inch tubing, locking sleeve and spring balls.
- Uses: folding dodger frames (DropTop™ style), spreader bars on biminis (strapless biminis), stowable dinettes and chart tables, cantilever supports for swim platforms and drop seats, support struts for davits and towers.



Part No.	Description	Tube Size: mm/in	Length: mm/in
G750SSET/3	Adjustable Strut	22 7/8	900 36
G750SSET/6	Adjustable Strut	25 1	900 36

*Note: Single strut – 2 struts required to make a folding top.

Gemlock™ Collapsible Frame Hinge

The Gemlock™ Hinge System is the most simple and effective way to build collapsible supports and folding frames.

- Simple operation: Slide back the locking sleeve and pop the hinge to fold frame.
- A complete installation will require 1 hinge, 1 locking sleeve, 2 snap buttons and 2 machine screws.
- Full installation instructions sheet available upon request.
- Use for folding: Spray hoods, biminis and tables.



Part No.	Description	Tube Size: mm/inch
G750S	Gemini Hinge	22 7/8
G751S	Gemini Hinge	25 1
G758	Snap Button, Hollow Head	
G760	Locking Sleeves	22 7/8
G761	Locking Sleeves	25 1

Side Mount Jaw Slide

- Allows outboard or inboard mounts of Gemlock struts.
- Outboard mount allows the Gemlock strut to act as grab rail.
- Grab rail stands off to allow bimini to fold flat.



Part No.	Description
G6355	25mm/1" Stainless Steel

Stainless Steel / Plastic Fittings

Canopy Hinge Fittings

These canopy hinge fittings for use on stainless steel tubing have been designed specifically for the marine industry. They are produced from type 316 stainless steel, and white nylon so that they will not corrode. The swivelling base design is unique in that it allows for any possible variation in deck lines to be accommodated, eliminating any need for machining or padding.

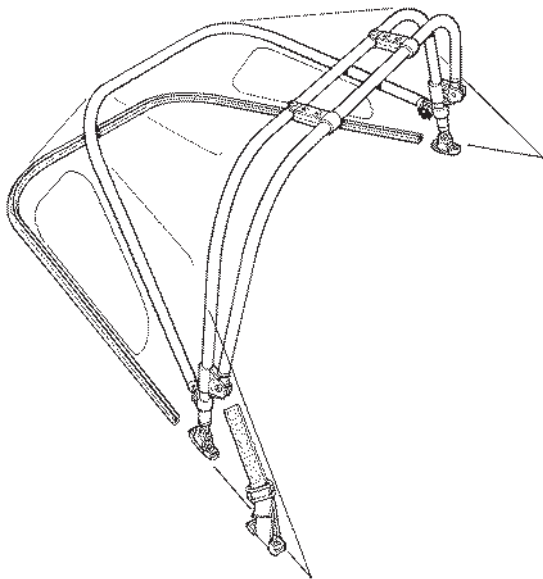

Universal Deck Fittings - Stainless/Plastic

A swivelling base fitting achieved by a three piece design allows for 200° variation in mounting angle

- Fitting consists of three pieces which assemble into one fitting.



Part No.	Description	Pack Qty
G603	Universal deck fitting	10

End Plugs - Stainless/Plastic

White nylon injection molding around 1/8 inch stainless steel.

- Plug can be secured by gluing, with a self tapping screw, or by a dowel pin.



Part No.	Tube (External): mm/in	Tube (Internal): mm/in	Pack Qty
G675	19 3/4	15.9 5/8	10
G676	19 3/4	16.7 11/16	10
G679	22 7/8	19.8 3/4	10

Canopy Slider & Track

Universal Deck Fitting mounted on Ronstan® 16mm track for simple and quick stowage of sprayhood frames.

- Universal deck fitting allows 200 degrees of rotation.
- 30cm/12" length of Type 316 stainless steel track supplied with plastic endcaps.
- Solid stainless steel track slide is fitted with easy grip plunger.
- Use with G675, G676 and G679.

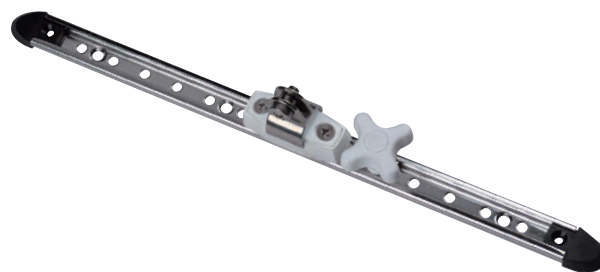

Part No.	Description
G590	Canopy Slide Track Unit Set
G590C	Canopy Slide Unit Only



Stainless Steel / Plastic Fittings

Canopy Slide Kit

Economical slide kit designed to utilise off cut tubes for track and slide.

- Each set comprises: 3 end plugs, 2 support pillars and 1 hand clamp.



Part No.	Description
G674	Canopy Slide Kit 3/4"

Duo Track System

- Quick release adjustment.
- Manufactured from 316 stainless steel.
- Ultra low profile design with positive locking mechanism.
- Easily operated by hand or foot.
- Ideal for mounting biminis on center cockpits.



G723END



G721S

Part No.	Tube (External): mm/in
G723END	Duo Track Stainless Steel End Stop
G721S	Duo Track Car with Low Profile Deck Hinge (G645S)

Tube Clamps - Stainless

- Clamp comes complete with spacer and screw to use with end plugs.
- Clamp fits over tube and allows movement of the plug space-end fitting.



Part No.	Tube (External): mm/in		Pack Qty
G655	19	3/4	10

Grab Rail Terminal Fitting

Grab rails add an additional safety feature to the canopy and can be easily retro-fitted.

- Made from type 316 stainless steel with nylon trim.
- Attaches to the grab rail with standard end plugs, and to the exposed part of the hood frame by clamping screws.
- Takes up any misalignment between the grab rail and the hood for easy fitting.
- Sold in handed pairs.



Part No.	Tube (External): mm/in		Pack Qty
G660	19	3/4	1 Pair
G661	22	7/8	1 Pair
G662	25	1	1 Pair

Stainless Steel / Plastic Fittings

Grab Rail Stand Off Fitting

Grab rails add an additional safety feature to the canopy and can be easily retro-fitted.

- Fixes to the existing frame and clamps to the grab rail.
- Fits around the cloth so that no cutting of the material is necessary.
- Maximum space between either the terminal fittings and a stand off fitting or between stand off fittings should not exceed 500mm (20 inches).



Part No.	Sprayhood to Rail Tube: mm/in		Pack Qty
G665	19 to 19	3/4 to 3/4	1 Pair
G666	22 to 19	7/8 to 3/4	1 Pair
G667	25 to 19	1 to 3/4	1 Pair
G668	22 to 22	7/8 to 7/8	1 Pair

Hand Clamps - Stainless

- Large nylon tensioning knob allows quick and simple adjustment.
- Clamp comes complete with spacer and screw to use with end plugs.
- Clamp fits over tube and allows movement of the plug space-end fitting.



Part No.	Tube (External): mm/in		Pack Qty
G650WT	19	3/4	10
G651WT	20	3/4	10
G652WT	22	7/8	10
G653WT	25	1	10

Boat Cover Socket

- Use one or more pairs of sockets with 40mm/1 3/4 " fiberglass batten material to support boat cover.
- Use No 8 flat or oval head screws.
- Sockets are sold in pairs only.

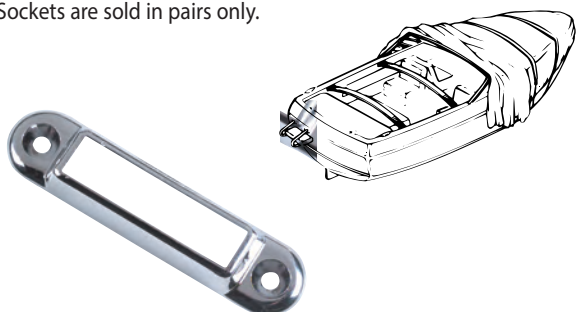

Part No.	Description	Pack Qty
G670	Chrome die cast	10 pair

Black Nylon Boat Top Fittings

- High strength black nylon fittings.
- Excellent resistance to UV.
- Works with either stainless steel or aluminium tubing.



Part No.	Description	Pack Qty
G621BK	For Use With Tube Outside Dia 22mm/ 7/8"	50
G620BK	For Use With Tube Outside Dia 22mm/ 7/8"	50
G622BK	Flat Fitting With Tube Pin	50

Sunblocker Clip

Sunblocker is a self insulated protective clip which eliminates contact between your metal tubular top frame and the clear plastic windows.

Two or three Sunblocker clips on metal frame tubing can give maximum protection against destruction of clear plastic windows, by reducing singeing, scorching and heat cracking.

- Marine grey colour.
- Designed cooling air vents.
- All rounded corners eliminates abrasion.

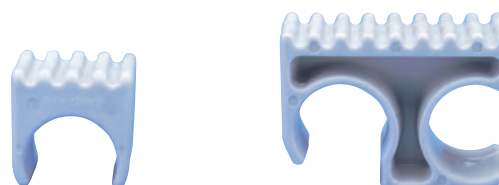

G638

G739

Part No.	Description	Pack Qty
G638	Single For Use with Tube Outside Diameter 22mm/ 7/8 "	50
G639	Single For Use with Tube Outside Diameter 25.4mm/1"	50

Awning Poles & Accessories

Adjustable Anodised Aluminium Awning Poles



Part No.	Description
G308	Adjusts from 1.2 to 2.4metres/4 to 8 feet
G309	Adjusts from 1.8 to 3.6 metres/6 to 12 feet - heavy duty

Adjustable Mooring Pole - Aluminium

Telescopic aluminium pole to keep boat cover taut and prevent puddling of water and leakage. Black plastic end fitting passes through a No. 1 grommet in the middle of the cover. A soft vinyl foot on the other end prevents damage to the floor. Positive locking screw allows easy adjustment to the correct height for a tight fit of the cover.

- Black plastic tapered end passes through No 1 grommet.
- Soft vinyl foot prevents damage to floor.
- Easy positive locking thumb screw.



Part No.	Size
G370	Adjusts from 1.0 to 1.3 metres/40 to 52 inches

Boat Vent II

- UV resistant material.
- Fast installation.
- No screws or awls needed.
- Fits 3/4" or 7/8" tubing.
- Attach to the top of adjustable mooring pole (G370).
- Use for venting the area below the cover.

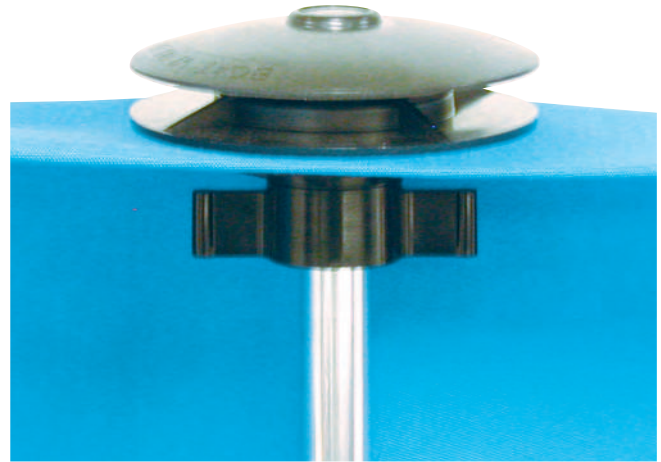

Part No.	Description
G050BK	Boat Vent II - Boat Cover Support and Vent

Vadney Clip

- Unique split design allows fitment of a screw to a track.
- Available in black only.
- Use with G151/ G106/ G115S.



Part No.	Description
G052BK	Black Vadney Clip

Dot® Fasteners

Commonsense Turnbutton Fasteners

Traditional fastenings for boat and marine covers and canvas work, recommended by Bainbridge International, for incorporating secure fastening combined with easy access.

- All manufactured in nickel plated brass.
- Available only in full packs of 100.
- Supplied with clinch plates where applicable.



Part No.	Description	Cutting Punch	Pack Qty
G100	Single stud with 2 screw base	-	100
G101	Double stud with 2 screw base	-	100
G103	Single stud with 2 prongs*	C951	100
G106	Single stud with brass screw	-	100
G104	Eyelet with regular prongs*	C132	100
G105	Eyelet with long prongs*	C132	100

*Including clinch plate

Pull-the-Dot Fasteners

- A heavy-duty, three sided locking snap fastener that is built to withstand extreme pressure on three sides without unlocking.
- When pulled on the fourth side where the Pull-the-Dot trademark appears, the fastener releases instantly.
- DOT fasteners are sold in full packs of 100 only.



G172



G173



Part No.	Description	Pack Qty
G172	Pull-the-Dot Socket	100
G173	Pull-the-Dot Stud	100

Note: Special tools are required.

Commonsense Cutting Punches

- To prolong life of tool, use a mallet and a cutting pad.



C950



C951

Part No.	Description	Fastener
C950	Cutting punch	G102/103
C951	Heavy Duty Cutting punch	G104/105

Lift-the-Dot® Fasteners

- All manufactured in nickel plated brass.
- Available only in full packs of 100.
- Supplied with clinch plates where applicable.



G110



G130



G113



G120



G119



G115S

Part No.	Description	Cutting Punch	Pack Qty
G110	Stud with 2 Screw Base	-	100
G130	Regular socket (including clinch plate)	C953	100
G120	Rivet Stud (including clinch plate)	-	100
G119	Single stud with 2 prongs (including clinch plate)	C950	100
G113	Stud with machine brass screw	C952	100
G118	Stud Windshield Clip 22mm/7/8	C952	100
G115S	Stud with 10mm/3/8" stainless steel screw	C952	100
G116S	Stud with 15mm/5/8" stainless steel screw	-	100

Lift-the-Dot® Tools

- To prolong life of tool, use a mallet and a cutting pad.



C952



C950



C953

Part No.	Description	Fastener
C950	Cutting punch	G119
C952	Cutting punch	G113/115/116
C953	Cutting punch	G130

Button Snap Fasteners

When superior snap action and holding strength is needed, DOT button snaps are the fastener to use. Self-piercing so no pre-punching is required, the snap fastener's heavy-duty construction assures a firm grip that will remain secure through years of use.

- All manufactured in nickel plated brass.
- Available only in full packs of 100.



G140



G151



G142



G145



G171



G143



G175

Part No.	Description	Setting Punch	Pack Qty
G140	Nickel Button with 5mm/ 3/16" barrel	C954/955	100
G140BU	Pacific Blue Button with 5mm/ 3/16" barrel	C954/955	100
G140BK	Black Button with 5mm/ 3/16" barrel	C954/955	100
G140WT	White Button with 5mm/ 3/16" barrel	C954/955	100
G140NV	Navy Blue Button with 5mm/ 3/16" barrel	C954/955	100
G140BKM	Military Black Oxide Button with 5mm/ 3/16" barrel	C954/955	100
G140TST	Beige Button with 5mm/ 3/16" barrel	C954/955	100
G141	Button with 6.5mm/ 1/4" barrel	C954/955	100
G142	Regular action socket	C954	100
G143	Stud for use with eyelet	C954/956	100
G145	Eyelet with 6.5mm/ 1/4" barrel	C954/956	100
G146	Eyelet with 8mm/ 5/16" barrel	C954/956	100
G147	Eyelet with 10mm/ 3/8" barrel	C954/956	100
G151	Stud with 12mm 1/2" Phillips head screw	C958	100
G152	Stud with 15mm/ 5/8" Phillips head screw	C958	100
G1520S	Stud with oversize stainless steel screw 15.9mm/ 5/8"	-	100
G171	Self Drilling stainless steel screw 12mm/ 1/2"	-	100
G175	Self Drilling stainless steel screw 20mm/ 3/4"	-	100
G171FW	Plastic Flexi Washer	-	100



Snap Fastener Hand Setting Tools

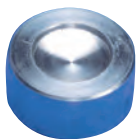

C955

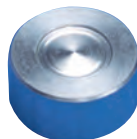

C956



C954

Part No.	Description	Cutting Punch	Fastener
C954	For buttons or eyelets	C955/956	G140/1/2/3/5/6/7
C955	For button	C954	G140/1
C956	For eyelet	C954	G145/6/7

Stainless Steel Button Snap Fastener

- The new all stainless steel DOT Buttons are stronger than the standard brass/nickel buttons, and also resist corrosion.
- The stainless steel barrels allows it to self-pierce through a greater variety and thickness of material without the need for pre-punching.
- The brass/nickel plated cap with stainless steel barrel self-pierces through nylons, Dacrons and webbings.
- G140BS - this button offers greater strength and higher quality than standard with low additional cost.
- Available only in full packs of 100.



G140SS

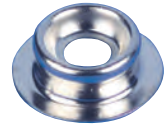

G143SS



G151SS



G142SS



G145SS

Part No.	Description	Setting Punch	Pack Qty
G140SS	S.S. Button with S.S. 5mm/ 3/16" barrel	C954/955	100
G141SS	S.S. Button with S.S. 6.5mm/ 1/4" barrel	C954/955	100
G142SS	S.S. Regular action socket	C954	100
G143SS	S.S. Stud for use with eyelet	C954/956	100
G145SS	S.S. Eyelet with 6.5mm/ 1/4" barrel	C954/956	100
G149SS	S.S. Easy action socket	C954/955	100

Twin Setting Bench Die

A new die solves the problem of setting two fasteners at once, by having two precisely spaced cavities allowing two buttons or eyelets to be installed at the same time.

- Time saving tool.
- Made from chrome-moly aerospace steel and is heat treated.

Note: One side is for 2 x buttons G140 and the other side is for 2 x eyelets G145.



Part No.	Description
C959	Button and Eyelet Tool

Fastener Tools

Press-N-Snap Tool

- Complete with die sets for Button Snap fasteners.

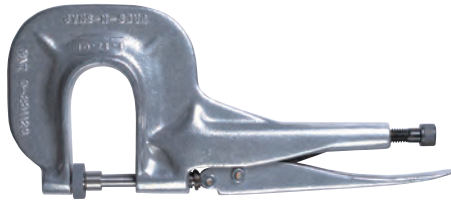

Part No.	Description	Fastener
C360	Closing tool for button snap fasteners	G140/147

Eyelet & Socket Setter

- Purpose built for setting Common Sense and Lift-a-Dot style fasteners.
- This unique, patented tool is designed to hold the washer in place and then bends the four prongs over in one operation.
- Includes storage/carrying pouch.

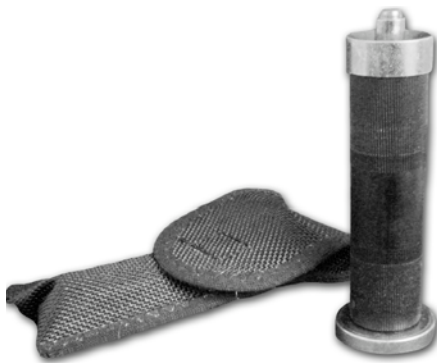

Part No.	Description
C939	Eyelet & Socket Setter

Dies for Durable Dots

- C361 - Four piece set.
- C361CAP - Die cap for Durable Dots
- C361SOCKET - Socket for Durable Dots



C361

Part No.	Description	Fastener
C361	Die Set	G140/7
C361CAP	Cap	G140/7
C361SOCKET	Socket	G140/7

Bench Press

- Deep throat and long padded handle improves leverage.
- Easily sets snap fasteners or self-piercing grommets.
- Light weight aluminum - ideal for portable applications where strength and weight savings are critical.
- Bench press machine will accept most dies with 9.5mm/ 3/8 inch shank.



Part No.	Material	Throat Depth mm/in	Approx Weight lbs	Use With Dies
C620	Steel	121 4 3/4	12	C941-5

Die Tools for use with Bench Press

- All dies have 9.5mm/ 3/8 inch diameter shank.



C941A



C941B



C942A



C942B



C944A



Part No.	Die	Mfg #	Use With
C941A	Top	1401	G140/G170 - Button
C941B	Bottom	1410	G142/G155/G172 - Socket
C942A	Top	1412	G143/G173 - Stud
C942B	Bottom	1407	G145/G146/G147 - Eyelet
C944A	Top	1456	G120 - Rivet Stud

Permalock Fasteners

Dies for Self-Piercing Grommets

- Self-holding Press-N-Snap grommet dies for use with self-piercing grommets and washers.
- Two piece sets.

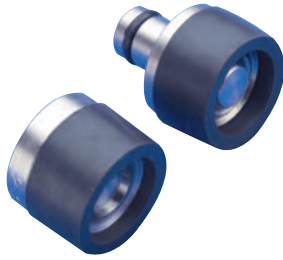

Part No.	Description	Mfg#
C366	Size 1, D101 or D111	230
C367	Size 2, D102 or D112	250

Permalock Fasteners

- All manufactured from Dupont® non-corrosive, UV stabilised "Zytel".
- Attach with flathead screws or rivets.
- Can be attached using 2 x G145/G147 eyelets.
- Available only in full packs of 100.



G160WT



G161WT



G160AWT

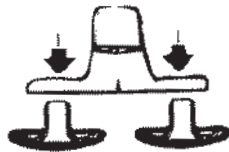

Turnbutton with Button Snap Fastener Assembly

Part No.	Description	Colour	Pack Qty
G160BK	Single stud with 2 screw base	Black	100
G160WT	Single stud with 2 screw base	White	100
G160ABK	Backplate for stud	Black	100
G160AWT	Backplate for stud	White	100
G161BK	Eyelet clinch lock (2 part)	Black	100
G161WT	Eyelet clinch lock (2 part)	White	100

Permalock Cutting Punch

- For use with G161BK/WT Permalock Fasteners.



Part No.	Description	Fastener
C140	Cutting punch for use with Permalock fasteners	G161

Tenax & YKK Fasteners

Tenax Fasteners

- Used on top quality marine and automotive covers.
- Positive lock.



Part No.	Description	Pack Qty
G164	Stud with whitworth machine screw	100
G165	Standard pull top w/lock washer	100
G166	Cloth base stud w/lock washer	100
G167	Wood screw stud	100
G168	2 Screw stud	100
G165TOOL	Tool for locating ring	1

YKK Dome Fastener

- Unique 40mm low profile design.
- Aggressive VHB adhesive pad on rear to attach to hull etc.
- Versions available to attach to button sockets or studs.
- Impact resistant.
- UV resistant.
- Available in off-white only.



Part No.	Description	Fastener
G190WT	YKK Dome Adhesive Fastener- for sockets G142/G155	
G191WT	YKK Dome Adhesive Fastener- for studs	G143

Windows, Mesh & Fabrics



Windows, Mesh & Fabrics

Window Material	110-111
Window Protection	112
Bag Material	112-114
Mesh Fabrics	115-117
Trampoline Mesh	118

Window Material

Calendered - Rolls

- UV stabilised vinyl.
- Available only on full rolls.

Part No.	Thickness: mm/in		Roll Width: mm/in		Roll Length: m/yd	
E204	0.4	0.016	1370	54	40	43.7
E206	0.5	0.020	1370	54	40	43.7
E205	0.7	0.028	1370	54	30	32.8



1000 hour UV Roll-A-Glass

- Passes 1000 hour UV weatherometer!
- Sparkling clarity, extended UV life window material.
- -10°F cold crack.
- USA standard: FR302 Fire resistant.



Part No.	Thickness: mm/in		Roll Width: mm/in		Roll Length: m/yd	
K631	0.50	0.02	1370	54	27	30

Glass Clear - Window Material

Clear PVC window material used in sprayhoods, biminis and cockpit covers. Available in sheet format. Extremely scratch resistant.



Part No.	Thickness: mm/in	Sheet Width: mm/in	Sheet Length: mm/in	Pack Qty
E203	1.0 0.04	1250 49.2	2500 98.4	Each

Strataglass - Scratch Resistant Glass

- Leading scratch resistant clear vinyl.
- Tested to 12 years accelerated UV.
- Easy roll-up, the same as regular vinyl.
- UV Blocking.
- Use: boat curtains, automotive windows, tent & awning applications.

STRATAGLASS



Canvas Designers Inc, FL

Strataglass - Clear

Part No.	Gauge Thickness: mm/in		Width: mm/in		Sheet Length: mm/in		Sheets Per Drum
K305/2	0.76	0.030	1370	54	2820	111	2
K305/5	0.76	0.030	1370	54	2820	111	5
K310/2	1.02	0.040	1370	54	2820	111	2
K310/5	1.02	0.040	1370	54	2820	111	5
K315/2	1.50	0.060	1370	54	2820	111	2

Strataglass - Smoke Tint

Part No.	Gauge Thickness: mm/in		Width: mm/in		Sheet Length: mm/in		Sheets Per Drum
 K310/2SM	1.02	0.040	1370	54	2820	111	2
K310/5SM	1.02	0.040	1370	54	2820	111	5

Strataglass - Light Smoke Tint

Part No.	Gauge Thickness: mm/in		Width: mm/in		Sheet Length: mm/in		Sheets Per Drum
K315/2LSM	1.02	0.040	1370	54	2820	111	5

Regalite® Flex Pressed Polished Window Material

- Best quality glass-clear PVC material.
- Regalite® is a registered trademark of Regalite Plastics Corporation, O'Sullivan Corporation.
- Available in sheet format.



Part No.	Gauge Thickness: mm/in		Sheet Width: mm/in	Sheet Length: mm/in		Qty per Drum
K221	0.50	0.020	740 29	1730	68	60
K222/5	0.76	0.030	1370 54	2270	109	60
K225/5	1.02	0.040	1370 54	2270	109	60

Crystal Clear Vinyl Sheets

- Clear vinyl sheets.

Part No.	Gauge Thickness: mm/in		Sheet Width: mm/in		Sheet Length: mm/in		Qty
K120/10	0.50	0.020	1370	54	2820	111	1

CLEAR-VU High Optical Clarity Roll Glass

Clear-VU is a top quality extruded vinyl product that offers optical clarity approaching the best press polished sheet vinyl, while still retaining the benefits of roll glass convenience.

- K432 is a soft hand similar to roll-a-glass in stiffness.



Part No.	Gauge Thickness: mm/in		Roll Width: mm/in		Roll Length: m/yd	
K432	0.76	0.030	1370	54	17.8	19.5
 K434	1.02	0.040	1370	54	17.8	19.5

DIAX-Clear Window Material

- Black polyester DIAX laminated with 4 mil optically clear film.
- Low stretch, high tear strength.
- Ideal for laminate and woven race sail windows.

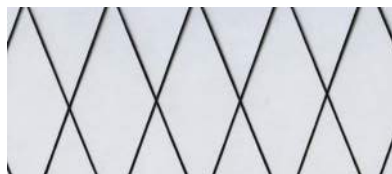

Part No.	Film: mil	Total DPI: Warp x Fill
F6002X00M	4	2 x 2 840 Black Polyester

SPF-uv™ Sun Protective Film

This clear UV resistant film with adhesive backing blocks virtually all damaging UV radiation. For application on roller furling genoas or to protect other materials from effects of UV rays.

Application recommendations:

- Use on a clean surface - dirt and salt will prevent an adequate bond.
- Stretch sail to be flat and free of wrinkles.
- Apply SPF-uv in sections (do not attempt one piece head to clew or tack to clew.)
- Keep minimum tension on SPF-uv to keep it flat but not distorted.
- Allow sufficient time for maximum bonding after applying SPF-uv.
- Roll sail with film to the outside roll.
- Check parts of the mast and rigging that could chafe sail.

Part No.	Width: mm/in		Weight: gm/oz		Film: mil
J822	508	20	81	1.9	0.5
J832	762	30	81	1.9	0.5
J862	1524	60	81	54	0.5

Monofilm

- See-through polyester film for a light weight performance material for boardsails and telltale windows.
- Use J080 series seaming tapes for sewing panels together.

Part No.	Thickness: mm/in		Roll Width: mm/in		Roll Length: m/yd		Weight: gm/oz	
E078	0.12	0.005	1370	54	46	50	111	3.9
E088	0.18	0.007	1370	54	46	50	156	5.5
E080	0.25	0.010	1370	54	46	50	224	7.9



Adhesive Backed Polyester Monofilm

- Repair clear film products.
- Pressure sensitive adhesive.
- Roll length: 45 metres / 50 yards.



Part No.	Width: mm/in	
J874	1370	54
J872	50	2

Telltale Windows

- Pre-cut Telltale Windows cut from E201 best quality material.
- Sold in full packs of 10 only.

Part No.	Diameter: mm/in		Thickness: mm/in	
E210	225	8 7/8	0.5	0.02

Melinex

- Clear polyester film for board sails.

Part No.	Thickness: mm/in		Roll Width: mm/in		Roll Length: m/yd	
E207	0.175	0.007	1524	60	40	43.7
E2075	0.175	0.007	1524	60	5	5.5

Window Protection & Bag Cloth

SUN SOX To Protect Plastic Windows

Windows resting against hot tube framing can be scorched and in turn, can be destroyed. New SUN SOX offer a simple and inexpensive protection solution.

Made from a non-woven poly blend of fibres with a velcro strip on one edge, SUN SOX simply wraps around tubing and secures to itself. 6 foot lengths can be cut to match tube size and is available in 6 popular colours.

- Simple do it yourself installation offers easy on and easy off or leave all year round.

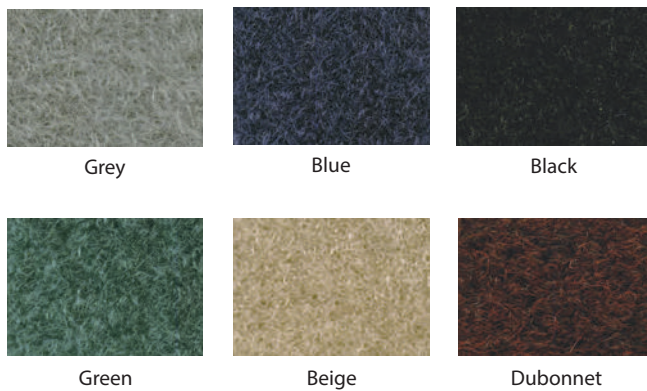
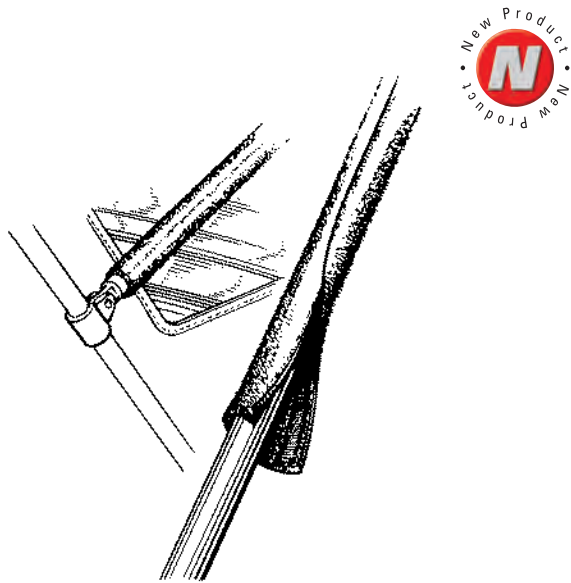

Part No.	Colour	Length m/ft	
LS401GY	Grey	1.8	6
LS401BU	Blue	1.8	6
LS401BK	Black	1.8	6
LS401GR	Green	1.8	6
LS401TN	Beige	1.8	6
LS401DB	Dubonnet	1.8	6

Nylon Bag Cloth

Coated Oxford nylon fabric for the manufacture of bags and dust covers and for a wide variety of other marine and industrial uses.

- 420 denier 50 x 36 construction.
- Mildew and stain resistant. Coated for water repellency.
- Weight: 210gsm/6.2 oz/sq yd.



Part No.	Colour	Width (Untrimmed): mm/in		Roll Length: m/yd
V006RD	Red	1500	60	100 109
V006BR	Bright Red	1500	60	100 109
V006YE	Yellow	1500	60	100 109
V006GR	Green	1500	60	100 109
V006NB	Navy Blue	1500	60	100 109
V006BU	Blue	1500	60	100 109
V006DG	Dark Grey	1500	60	100 109
V006GY	Silver Grey	1500	60	100 109
V006WT	White	1500	60	100 109
V006BK	Black	1500	60	100 109

Other colours available against special order. All special order items are subject to minimum order quantities and additional lead times. Prices on application.



Bag Material

70 Denier PVC Nylon

70 Denier woven nylon with embossed pigmented PVC coating on one side. Uses: Banners, Indoor covers, Sport Bags, soft-sided luggage.



Black

Green

Light Grey



Orange

Royal Blue

Red



White

Yellow

Part No.	Colour	Width: mm/in		Roll Length: m/yd	
FH070BK	Black	1520	60	101	110
FH070GRN	Green	1520	60	101	110
FH070GY	Light Grey	1520	60	101	110
FH070OR	Orange	1520	60	101	110
FH070RB	Royal Blue	1520	60	101	110
FH070RD	Red	1520	60	101	110
FH070WT	White	1520	60	101	110
FH070YE	Yellow	1520	60	101	110



Nylon High Intensity colours are likely to fade quickly. Nylon may bleed when wet!

210 Denier Oxford Nylon

- Durable, water repellent urethane coated. UV inhibited 210 denier nylon.
- Uses: Sail bags, soft-sided luggage, backpacks, garment bags, stuff bags, flags, banners, apparel.
- Weight: 105gsm/3.1oz/sq yd.



White

Grey

Red

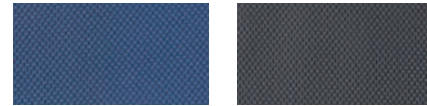

Royal Blue

Black

Part No.	Colour	Width: mm/in		Av Roll Length: m/yd	
F5600D00W	White	1520	60	101	110
F5600D08W	Grey	1520	60	101	110
F5600D10W	Red	1520	60	101	110
F5600D79W	Royal Blue	1520	60	101	110
F5600D60W	Black	1520	60	101	110

1000 Denier Textured Nylon

- 1000 denier super tough woven high tenacity nylon with a 33gsm/1 ounce urethane coating for durability and water repellency.
- Excellent resistance to abrasion, fading, rot and mildew.
- Water repellent and quick drying.
- High tensile strength and tear resistance.
- Uses: Heavy duty bags, soft-sided luggage, apparel, horse blankets, backpacks, recreational equipment.
- Weight: 458gsm/13.5oz/sq yd.



Silver

White

Charcoal Grey



Red

Royal Blue

Navy Blue



Forest Green

Yellow

Black

Part No.	Colour	Width: mm/in		Av Roll Length: m/yd	
F5300D08W	Silver	1520	60	46	50
F5300D00W	White	1520	60	46	50
F5300D58W	Charcoal Grey	1520	60	46	50
F5300D10W	Red	1520	60	46	50
F5300D79W	Royal Blue	1520	60	46	50
F5300D22W	Navy Blue	1520	60	46	50
F5300D46W	Forest Green	1520	60	46	50
F5300D35W	Yellow	1520	60	46	50
F5300D60W	Black	1520	60	46	50

Bag Material

Fabrene Bag Material

Economical, light and non absorbent bag material.

- Stable yet flexible.
- Used for bags and accessories. Especially good for light 'sausage' type sail bags on race boats.
- Waterproof.
- Non absorbent and light.
- Semi permanent pattern material.
- Other colours available against special order.



Clear



Navy Blue

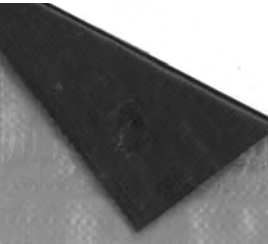

Silver/Black



Semi Transparent

Part No.	Style	Roll Length:		Width:	
		m/yd		mm/in	
FP072CL	Clear	200	218	1830	72
FP072NB	Navy Blue	200	218	1830	72
FP072SB	Silver/Black	200	218	1830	72
FP080CL	Semi Transparent	200	218	1830	72

PFP Knit Polyester

A lightweight knitted 100% polyester ideal for spinnaker snuffer and socks.

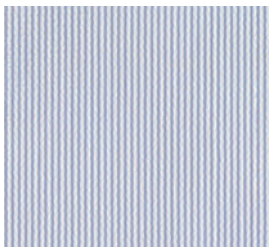

Part No.	Colour	Roll Length:		Width:	
		m/yd		mm/in	
FHKP60WT	Optic White	50	54	1530	60

Note: Information correct at time of print. Other colours available against special order. Colour representation from 4-colour process and for reference purposes only. Please inquire for colour sample of actual fabric.



Dyed nylon fabrics may not be totally colourfast, especially when damp or when used in humid conditions, or if in contact with materials having free solvents, even in trace quantities. No guarantee can therefore be given related to colour fastness. Customers should satisfy themselves about the suitability of the selected fabric for the application in question.



Mosquito Netting

- Flame retardant: standard CPA184, USA.
- Uses: For insect screens.
- Weight: 31gsm/0.9oz/sq yd.
- Available only on full rolls.



Part No.	Colour	Roll Width: mm/in
FH172GY	Slate Grey	1828 72

Light Weight Polyester Knit Mesh

- Uses: Breathable panels for bags/safety nets.
- Weight: 108gsm/3.2 oz/sq yd.

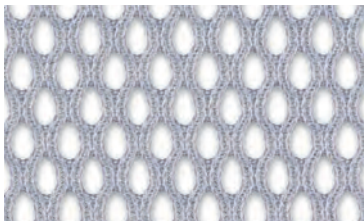

Part No.	Colour	Roll Width: mm/in
FH062WT	White	1575 62
FH062BK	Black	1575 62

Multi Purpose FR Mesh

- 9 x 12 knitted polyester mesh with vinyl coating.
- Fire retardant, meets California Fire Marshall 117, section E specifications, USA.
- Uses: Wind and sun screens, breathable cushion bottoms.
- Weight: 271gsm/8 oz/sq yd.

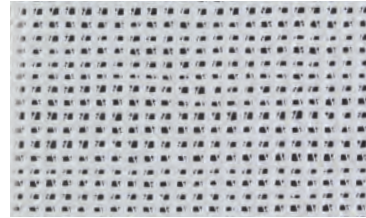

Part No.	Colour	Roll Width: mm/in
FH162WTFR	White	1575 62

Leno Mesh

- Firm nylon mesh with very low stretch in all directions.
- Weight: 329gsm/9.7oz/sq yd.
- Uses: Trampolines, breathable panels for bags, backpacks.



Part No.	Colour	Roll Width: mm/in
FH058BK	Charcoal	1500 55

Mesh Fabrics

Sleeveknit Vinyl Mesh

- Uses: Windscreens, truck and pool covers, bags, outdoor furniture, shade cloth.
- Weight: 220gsm/6.5 oz/sq yd.



Red

Bermuda Blue

Black

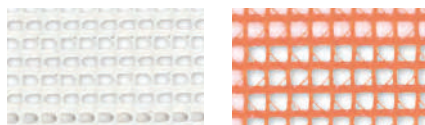

White

Fluoro Orange

Part No.	Colour	Roll Width: mm/in
FH160RD	Red	1524 60
FH160BU	Bermuda Blue	1524 60
FH160BK	Black	1524 60
FH160WT	White	1524 60
FH160FO	Fluoro Orange	1524 60

Heavy Weight Polyester Knit Mesh

- Uses: Breathable panels for bags/safety nets.
- Weight: 339gsm/10 oz/sq yd.

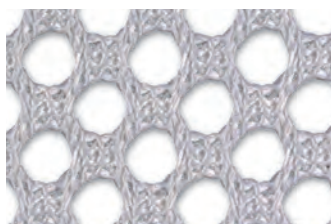

Part No.	Colour	Roll Width: mm/in
FH063WT	White	1600 63

SUNSURE® - Mesh

- 42 x 12 woven PVC vinyl encapsulated polyester mesh material, 95% shade factor.
- Features: Tighter mesh than standard Textilene.
- Fire retardant, meets California, Fire Marshall 117, section E specifications, USA.
- Uses: Wind and sun screens, banners.
- Weight: 550gsm/16.3oz/sq yd.



TEXTILENE
SUNSURE
BRAND FABRIC

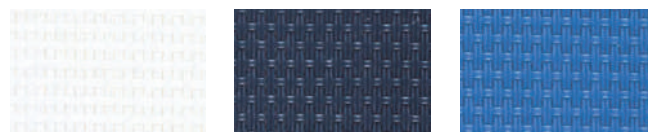

White

Navy Blue

Royal Blue



Dove Grey

Black

Part No.	Colour	Roll Width: mm/in	Roll Length: m/yd
FH359WT	White	1370 54	59 65
FH359NV	Navy Blue	1370 54	59 65
FH359RB	Royal Blue	1370 54	59 65
FH359GY	Dove Grey	1370 54	59 65
FH359BK	Black	1370 54	59 65

SUNSURE PLUS® - Mesh

- PVC vinyl encapsulated 500d polyester core mesh material.
- 95% shade factor.
- Mildew resistant.
- Fire retardant: meets CA Title 19 & NFPA 701-2004, USA.
- Uses: Screens, banners, outdoor furniture.
- Weight: 485gsm/14.3oz/sq yd.
- Other colours available to special order.
- Width: 1525mm/61"



Black

TEXTILENE
SUNSURE plus
BRAND FABRIC



White

Burgundy

Desert Tan

Part No.	Colour	Roll Width: mm/in	Roll Length: m/yd
FH357BK	Black	1525 61	54 60
FH357WT	White	1525 61	54 60
FH357BG	Burgundy	1525 61	54 60
FH357DSD	Desert Tan	1525 61	54 60

Mesh Fabrics

TEXTILENE® - Mesh

- PVC vinyl encapsulated polyester mesh material.
- Very strong with excellent tear and abrasion resistance.
- Fire retardant, meets California, Fire Marshall 117, section E specifications, USA.
- Fade resistant.
- 45% to 65% shade factor depending on color.
- Uses: Wind and sun screens, breathable cushion bottoms, banners.
- Weight: 350gsm/10.3oz/sq yd.



TEXTILENE
BRAND FABRIC

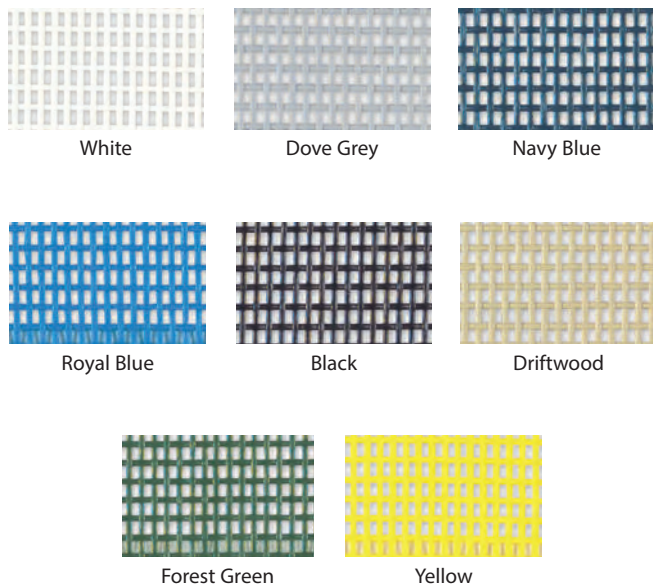

Part No.	Colour	Roll Width: mm/in	Roll Length: m/yd
FH354WT	White	1370 54	59 65
FH354GY	Dove Grey	1370 54	59 65
FH354NV	Navy Blue	1370 54	59 65
FH354RB	Royal Blue	1370 54	59 65
FH354BK	Black	1370 54	59 65
FH354AL	Driftwood	1370 54	59 65
FH354GR	Forest Green	1370 54	59 65
FH354YE	Yellow	1370 54	59 65

TEXTILENE PLUS® - Mesh

- PVC vinyl encapsulated polyester mesh material.
- Fire retardant, meets CA Title 19 & NFPA 701-2004, USA.
- 88% to 92% shade factor depending on colour & profile angle.
- Other colours available to special order.
- Weight: 414gsm/12.2oz/sq yd.



Navy

TEXTILENE plus
BRAND FABRIC



Black



Royal Blue



Beige



White



Grey



Desert Tan

Part No.	Colour	Roll Width: mm/in	Roll Length: m/yd
FH352NV	Navy	1525 61	54 60
FH352WT	White	1525 61	54 60
FH352GY	Grey	1525 61	54 60
FH352RB	Royal Blue	1525 61	54 60
FH352BI	Beige	1525 61	54 60
FH352BK	Black	1525 61	54 60
FH352DSD	Desert Tan	1525 61	54 60

Fibreglass Screen

- Long wear fibreglass screen with excellent flexing and superior ultraviolet resistance.
- Fire retardant (CPAI-84), USA.
- 18 X 14 construction.
- Uses: Insect and bug screens. Boat cover vents.
- Weight: 85gsm/2.5 oz/sq yd.

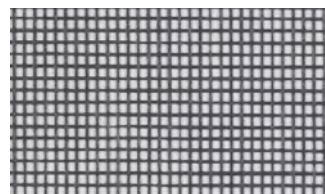

Part No.	Colour	Roll Width: mm/in	Roll Length: m/yd
FH372CG	Slate Grey	1830	72

Trampoline Mesh

Trampoline Cloth

- UV inhibited monofilament polypropylene basketweave.

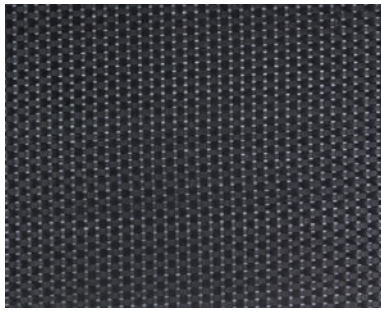

Technical Information

Thickness : mil (US) / mm (UK)	20	0.508
Weight : gsm / oz/sq yd	271	7.9
Width : mm / in	1880	74
Tensile Strength Grab Method : lbs	Warp: 440	Weft: 365
Tear Strength Trapezoid Method : lbs	Warp: 185	Weft: 190
Burst Strength Mullen : psi	825	
Puncture Strength : gms / lbs	190	
UV Resistance (at 5000 hours) % strength retained	70	

Part No.	Colour	Roll Width: mm/in	
FH374BK	Black	1880	74
FH374BK4	Black	3937	155

Heavy Duty Tramp

Heavy duty trampoline is a very strong woven polyester mesh that has a thick vinyl coating with UV and mildew inhibitors. Designed for industrial applications as well as trampolines on large catamarans.

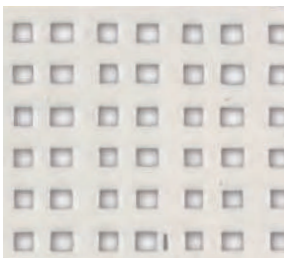

Technical Information

Yarn : detex PES HT	1100	
Weight : gsm / yd	848	25
Width : mm / in	1800	71
Tensile Strength : daN/5cm	300/300	
Tear Strength : daN	60/60	
Openess Factor : %	±19	
Extreme Working Temperatures : °C	-30 / +70	
Flame Retardency	M2	
Wind Permeability : %	±7	

Part No.	Colour	Roll Width: mm/in	
FH590WT	White	1800	71
FH590BK	Black	1800	71

Extra Heavy Duty SuperTramp

SuperTramp, with mildew inhibitors, is designed for outdoor tensile structures where strength, durability and resistance to the elements is required. SuperTramp can be used for large catamaran applications, for greater strength and durability than standard trampoline products. It has also been used for large fixed outdoor shades, with its FR standard M2 rating (equal to NFPA 701).

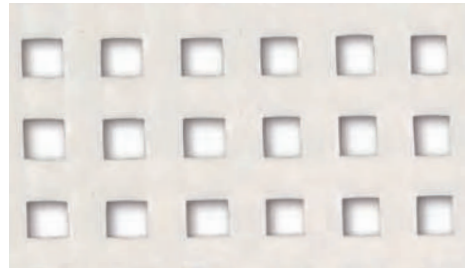

Technical Information

Yarn : detex PES HT	1670	
Weight : gsm / oz/sq yd	1017	30
Width : mm / in	1800	71
Tensile Strength : daN/5cm	400/250	
Tear Strength : daN	100/55	
Openess Factor : %	±24	
Extreme Working Temperatures : °C	-30 / +70	
Flame Retardency	M2	
Wind Permeability : %	±10	

Part No.	Colour	Roll Width: mm/in	
FH592WT	White	1800	71



The Loft

Sailcloth Jackets	120
Sailcloth Barrel Bags	121
Sailcloth Deluxe Holdalls	121
Sailcloth Washbags	122
Sailcloth Tote Bag	122

Sailcloth Jackets

The Loft

We have used our knowledge in the application of technical fabrics to design this exciting range of jackets, bags and accessories. Each item in the collection is made from genuine Bainbridge Ocean Sailcloth and features our very own insignia sail numbers.

Our jackets, bags and accessories are designed to be practical and hardwearing, stylish and unique – with a different combination of sail numbers going onto each one.



Unisex Ocean White & Classic Cream Sailcloth Jackets

- Roll away hood
- Soft fleece lining for extra warmth and comfort
- Durable, splashproof sailcloth outer
- Authentic zigzag double stitched seams
- Inside pocket
- Cosy fleece lined and reinforced zip pockets
- Adjustable cuffs
- Scooped back hem
- Drawstring waist for a tailored fit

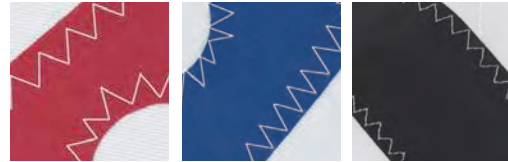

Jackets incorporate our original insignia sail numbers in red, blue or black



Ocean White Part No.	BMZ3300	BMZ3301	BMZ3302	BMZ3303	BMZ3304	BMZ3305
Classic Cream Part No.	BMZ3310	BMZ3311	BMZ3312	BMZ3313	BMZ3314	BMZ3315
Unisex	XS	S	M	L	XL	XXL
Men's chest (inches)	32 – 34	35 – 36	37 – 39	40 – 43	44 – 46	47 – 50
Men's chest (cm)	81 – 87	89 – 92	94 – 99	102 – 109	112 – 117	117 – 127
Ladies dress size (UK)	8 – 10	12	14	16	18 – 20	20+
Ladies size (cm)	86	91	96	101	105	110
Waist (inches)	n/a	28 – 31	31 – 34	34 – 36	37 – 39	39 – 42



Sailcloth Bags

Grey Barrel Bags

Manufactured from grey polyester sailcloth, these barrel bags are convenient and affordable. Available in 3 handy sizes, these barrel bags are great for carrying your kit and stowing into lockers.

- Made from genuine Bainbridge woven sailcloth
- Durable and splashproof
- Reinforced handles
- Grab handle on the end (medium only)
- Red, blue or black insignia sail numbers



Part No.	BMZ1001	BMZ1002	BMZ1003
Size	S	M	L
Bag Dims (in)	20L x 10 W	24L x 12W	28L x 15W
Bag Dims (cm)	50L x 25W	60L x 30W	70L x 37W
Capacity (L)	24	43	75

White Barrel Bags

With the same features as the grey barrel bags, these white bags are fashionable and convenient. Available in 3 handy sizes.

- Made from genuine Bainbridge woven sailcloth
- Durable and splashproof
- Reinforced handles
- Grab handle on the end (medium only)
- Red, blue or black insignia sail numbers



Part No.	BMZ1101	BMZ1102	BMZ1103
Size	S	M	L
Bag Dims (in)	20L x 10 W	24L x 12W	28L x 15W
Bag Dims (cm)	50L x 25W	60L x 30W	70L x 37W
Capacity (L)	24	43	75

White Deluxe Holdalls

Made from Bainbridge's Ocean woven sailcloth, each one of these stylish holdalls features a unique combination of original sail numbers, is super strong and has a large zip opening. With reinforced handles, lots of useful pockets and a splashproof finish, these holdalls will keep everything safe.

- Made from genuine Bainbridge Ocean woven sailcloth
- Durable & splashproof
- Large top opening for convenience
- Reinforced handles
- Grab handle on the end
- Red, blue or black original insignia sail numbers
- Interior and exterior pockets



Part No.	BMZ1201	BMZ1202	BMZ1203
Size	S	M	L
Bag Dims (in)	20L x 10 W	24L x 12W	28L x 15W
Bag Dims (cm)	50L x 25W	60L x 30W	70L x 37W
Capacity (L)	24	43	75



Please note that all jacket and bag sizes are approximate.

Sailcloth Washbags & Tote Bag

Washbag - Small

These nautical wash bags are made from Bainbridge Ocean sailcloth and feature original insignia sail numbers. The small washbag can be used as a ladies make-up bag, as a shaving kit for men, or simply as an overnight wash bag!

- Made from Bainbridge Ocean woven sailcloth
- Red, blue or black original insignia sail numbers
- Splashproof
- Exterior zipped pocket
- Unisex



Part No.	BMZ2001
Size	S
Bag Dims (in)	8L x 6H x 3W
Bag Dims (cm)	21L x 14H x 7W
Capacity (L)	1.8

Washbag - Large

These nautical wash bags are made from Bainbridge Ocean sailcloth and feature original insignia sail numbers. The large wash bag features a sturdy wide opening and is big enough to store all of your toiletries - at home, on the boat or on holiday. They also make ideal gifts!

- Made from Bainbridge Ocean woven sailcloth
- Red, blue or black original insignia sail numbers
- Splashproof
- Sturdy, wide top opening
- Exterior and interior pockets
- Unisex



Part No.	BMZ2002
Size	L
Bag Dims (in)	10L x 7H x 6W
Bag Dims (cm)	26L x 18H x 16W
Capacity (L)	7.5

Tote Bag

Bainbridge's ladies tote bag is the perfect sized shopper or beach bag. The soft rope handles are the perfect length to fit comfortably over your shoulder or down by your side and the nautical design is stylish and on trend. The rope handles are sewn under the bag for extra durability, so you can confidently fill it up!

- Made from Bainbridge Ocean woven sailcloth
- Red, blue or black original insignia sail numbers
- Splashproof
- Soft rope handles for comfort
- Durable design
- Convenient size
- Interior zipped pockets
- Magnetic clasp closing



Part No.	BMZ2003
Strap Length	9 in / 23cm
Bag Dims (in)	16L x 12H x 4W
Bag Dims (cm)	40L x 30H x 10W
Capacity (L)	12

Please note that all jacket and bag sizes are approximate.

Index by Part Number

Part No.	Page	Part No.	Page	Part No.	Page	Part No.	Page
06R	11	15D1100T45	7	20PR1400S7	4	40CSP0800	9
06REC	11	15D1100X45	7	20PR1600S3	4	40CSP0900	9
08R	11	15D1200	7	20PR1600S5	4	40CSP1000	9
08REC	11	15D1200T45	7	20PR1600S7	4	40CSP1100	9
10CSOJ	8	15D1200T50	7	20PR1800S3	4	40CSP1200	9
10CSTJ	8	15D1200X45	7	20PR1800S5	4	40CSP1400	9
10CXSTJ	8	15D1200X50	7	20PR1800S7	4	40CSP1600	9
10D0300	6	15D1400	7	20PR2000S3	4	40CSP1800	9
10D0400	6	15D1400T45	7	20PR2000S5	4	40CSP2000	9
10D0500	6	15D1400T50	7	20PR2000S7	4	40CST1000	9
10D0600	6	15D1400X45	7	20PR2200S3	4	40CST1200	9
10D0700	6	15D1400X50	7	20PR2200S5	4	40CST1400	9
10D0800	6	15DNECI	7 & 8	20PR2200S7	4	40CST1600	9
10D0900	6	15DNECO	7 & 8	20R	11	40CST1800	9
10D1000	6	15DS0400	7	20REC	11	40CST2000	9
10D1000T45	6	15DS0500	7	25CTJM	11	40CT	10
10D1100	6	15DS0600	7	25NTM	10	40CTST	10
10D1100T50	6	15DS0700	7	30CEC	9 & 11	40CXST1000	9
10D1200	6	15DS0800	7	30CSN0600	9	40CXST1200	9
10D1200T45	6	15DS0900	7	30CSN0700	9	40CXST1400	9
10D1200T50	6	15DS1000	7	30CSN0800	9	40CXST1600	9
10D1400	6	15DS1100	7	30CSN0900	9	40CXST1800	9
10D1400T45	6	15DS1200	7	30CSN1000	9	40CXST2000	9
10D1400T50	6	15DWEC	7 & 8	30CSN1200	9	A001	12
10DECL	6	15DXSTECI	7	30CSN1400	9	A002	12
10DECO	6	15EC002	5	30CSN1600	9	A004	12
10DS0400	6	15PR0600S3	4	30CSP0400	9	A005	12
10DS0500	6	15PR0600S5	4	30CSP0500	9	A006	12
10DS0600	6	15PR0800S3	4	30CSP0600	9	A006M	16
10DS0700	6	15PR0800S5	4	30CSP0700	9	A007	16
10DS0800	6	15PR1000S3	4	30CSP0800	9	A008	16
10DS0900	6	15PR1000S5	4	30CSP0900	9	A008M	16
10DS1000	6	15PR1200S3	4	30CSP1000	9	A009	16
10DS1100	6	15PR1200S5	4	30CSP1100	9	A0091	16
10DS1200	6	15PR1200S7	4	30CSP1200	9	A011	17
10DXSTECI	6	15PR1400S3	4	30CSP1400	9	A012	17
10R	11	15PR1400S5	4	30CSP1600	9	A013	17
10REC	11	15PR1400S7	4	30CSP1800	9	A014	17
12R	11	15PR1600S3	4	30CSP2000	9	A015	17
12REC	11	15PR1600S5	4	30CSP2200	9	A016	17
14R	11	15PR1600S7	4	30CST0700	9	A016S	17
14REC	11	15PR1800S3	4	30CST0800	9	A017	17
15C0800	8	15PR1800S5	4	30CST0900	9	A017S	17
15C0900	8	15PR1800S7	4	30CST1000	9	A018	17
15C1000	8	15PR2000S3	4	30CST1200	9	A018S	17
15C1100	8	15PR2000S5	4	30CST1400	9	A019	17
15C1200	8	15PR2000S7	4	30CST1600	9	A019S	17
15C1400	8	15PR2200S3	4	30CST1800	9	A021	19
15CSOJ	8	15PR2200S5	4	30CST2000	9	A022	19
15CSTJ	8	15PR2200S7	4	30CSTJ	8	A023	19
15CT	10	16HCP	10	30CT024	10	A024	19
15CTECI	11	16R	11	30CT031	10	A026	19
15CTECO	11	16REC	11	30CT044	10	A027	19
15CTST	10	20CV062	10	30CT052	10	A028	19
15CXSTJ	8	20CV080	10	30CTEC	11	A029	18
15D0300	7	20CV107	10	30CXST0700	9	A030N	20
15D0400	7	20CV125	10	30CXST0800	9	A030W	20
15D0500	7	20PR0600S3	4	30CXST0900	9	A031	17
15D0600	7	20PR0600S5	4	30CXST1000	9	A031C	17
15D0700	7	20PR0800S3	4	30CXST1200	9	A032	17
15D0800	7	20PR0800S5	4	30CXST1400	9	A033	17
15D0900	7	20PR1000S3	4	30CXST1600	9	A035BK	19
15D1000	7	20PR1000S5	4	30CXST1800	9	A036	96
15D1000T45	7	20PR1200S3	4	30CXST2000	9	A038	21
15D1000T50	7	20PR1200S5	4	40CEC	9 & 11	A039	21
15D1000X45	7	20PR1200S7	4	40CSP0500	9	A043	23
15D1000X50	7	20PR1400S3	4	40CSP0600	9	A044	23
15D1100	7	20PR1400S5	4	40CSP0700	9	A045	23

Index by Part Number

Part No.	Page	Part No.	Page	Part No.	Page	Part No.	Page
A049	23	A130BK	49	B044	17	B2118	41
A049	23	A131BK	49	B057	28	B214	44
A052	25	A134BK	49	B057A	28	B218B	44
A054	31	A135BK	49	B057AN	28	B219	44
A055	31	A140	38	B067	29	B220	44
A056	30	A141	38	B067A	29	B221	44
A057	28	A141BK	49	B067AN	29	B223	44
A057A	28	A142BK	49	B087	47	B225	44
A057ABK	28	A145BK	38	B089	22	B225B	44
A057BP	28	A147BK	39	B0901	22	B226B	44
A058	28	A150	11	B0902	22	B227	44
A058	28	A159BK	49	B0903	22	B228	44
A059	31	A188A	21	B091	22	B229	44
A060	28	A300BK	13	B092	22	B229B	44
A061	30	A300WT	13	B093	22	B248	45
A061A	30	A302	12	B097	22	B250	45
A062	31	A303BK	13	B101	18	B301	29
A063A	29	A303WT	13	B102	18	B301A	29
A063BP	29	A305BK	13	B103	18	B301AN	29
A066	30	A305BK	13	B110	20	B302	30
A066A	30	A305SS	13	B117	44	B303	13
A067	29	A305WT	13	B118	44	B307	16
A067A	29	A306BK	13	B119	44	B308	16
A068BK	65	A306SS	13	B120	44	B309	16
A068WT	95	A306WT	13	B121	44	B401S	95
A069BK	95	A310	18	B122	44	B411	20
A069WT	65	A313	18	B123	44	B412	20
A071	95	A315	18	B124	44	B413	20
A072BK	47	A4081	14	B125	44	B414	20
A073	47	A4082	14	B126	44	B431	15
A074	47	A4121	14	B127	44	B449	37
A075	47	A4121S	14	B127B	44	B450	37
A076	47	A4122	14	B129	20	B451	37
A076HD	47	A4161	14	B130	20	B452	37
A077HD	47	A4161S	14	B131	20	B453	37
A078WT	47	A4162	14	B133	39	B461	38
A079BK	47	A419	15	B134	39	B462	38
A079WT	47	A4201	14	B135	39	B463	38
A080BK	30	A4201S	14	B136	39	B464	38
A082	13	A4202	14	B137	39	B504	21
A083BK	31	A423	15	B138	39	B505	21
A085	47	A443	14	B140	39	B506	21
A087	47	A444	14	B153	39	B507	21
A088	47	A453	14	B154	39	B508	21
A089	47	A454	14	B155	39	B510	21
A089WT	47	A511	21	B156	39	B511	21
A091WT	95	A512	21	B158	39	B512	21
A095BK	49	A513	21	B165	45	B513	21
A095WT	49	A514	21	B169	46	B514	21
A096BK	49	A515	20	B170	44	B515	21
A096WT	49	A516	20	B171	44	B516	21
A097BK	49	A517	20	B172	44	B518	20
A097WT	49	A518	20	B173	44	B519	20
A101	38	A550BK	37	B174	46	B520	20
A102	38	A550BK	37	B191	45	B528	20
A105	37	B006	16	B196	45	B529	20
A106BK	37	B008	16	B197	45	B531	21
A107	16	B009	16	B204	45	B532	21
A108	16	B010	16	B2075	41	B533	21
A109	16	B011	18	B2075C	41	B535	20
A114	16	B012	18	B2076	41	B536	20
A116	16	B013	18	B2076C	41	B538	20
A117	16	B014SS	18	B2095	41	B540	39
A118	16	B015SS	18	B2095C	41	B541	39
A120BK	48	B016SS	18	B2096	41	B542	39
A122BK	49	B035	17	B2106	41	B542N	39
A124BK	49	B036	17	B2108	41	B543	39
A125BK	49	B037	17	B2116	41	B543N	39

Index by Part Number

Part No.	Page	Part No.	Page	Part No.	Page	Part No.	Page
B544	39	B926SR	26	C061	70	C367	107
B544N	39	B927BK	26	C063	70	C407	41
B545N	39	B927SR	26	C101	77	C408	41
B546	39	B931BK	27	C102	77	C409	41
B547	39	B936BK	27	C103	42 & 77	C410	41
B549N	39	B942ABK	26	C104	77	C411	41
B605	20	B942BBK	26	C105	42 & 77	C412	41
B605	20	B942CBK	26	C106	42 & 77	C413	41
B606	20 & 96	BMZ1001	121	C107	42 & 77	C414	41
B606	20	BMZ1002	121	C108	42 & 77	C449	38
B610	46 & 96	BMZ1003	121	C109	42 & 77	C501	77
B610S	46	BMZ10101	121	C110	42	C515	76
B611	46	BMZ1101	121	C111	42	C516	76
B611N	46	BMZ1102	121	C112	77	C517	76
B611S	46	BMZ1102	121	C113	77	C519	72
B611SW	46	BMZ1103	121	C114	42 & 77	C519	72
B612	46	BMZ1103	121	C116	77	C523	61
B612S	46	BMZ1201	121	C117	77	C530	76
B615	46	BMZ1202	121	C119	77	C530R	76
B617S	46	BMZ1203	121	C120	77	C531	76
B632	47	BMZ2001	122	C122	77	C550-10	74
B637	47	BMZ2002	122	C125	77	C550-12	74
B651	46	BMZ2003	122	C140	107	C551-7	75
B652	46	BMZ3300	120	C233	76	C551-8	75
B701	21	BMZ3301	120	C234	76	C551-9	75
B702	12	BMZ3302	120	C301	42	C552-10	75
B703	21	BMZ3303	120	C302	42	C552-12	75
B710	20	BMZ3304	120	C303	42	C552L-10	75
B720	15	BMZ3305	120	C303C	43	C553	75
B723	15	BMZ3310	120	C303S	43	C554	75
B805	23	BMZ3311	120	C304	42	C555-10	75
B806	23	BMZ3312	120	C304C	43	C555-12	75
B813	25	BMZ3313	120	C304S	43	C561	75
B814	25	BMZ3314	120	C305	42	C705	79
B817	24 & 25	BMZ3315	120	C305C	43	C706	79
B818	25	C005	71	C305S	43	C710	79
B825	25	C010	71	C306	42	C713	79
B827	25	C012	71	C306C	43	C754	72
B845	23	C013	71	C306S	43	C758	72
B847	23	C014	71	C307	42	C807	74
B847A	23	C015	71	C307C	43	C820	74
B856N	23	C016	71	C307S	43	C820R	74
B907N	23	C017	71	C308	42	C832	74
B908	24	C018	71	C308S	43	C834	74
B908N	24	C019	71	C309	42	C850	73
B909	24	C021	71	C309S	43	C852	73
B909N	24	C022	71	C321	27	C853	73
B909SR	24	C023	71	C322	27	C854	73
B910	24	C024	71	C323	27	C856	73
B910N	24	C025	71	C324	27	C857	73
B910SR	24	C026	71	C325	27	C857B	73
B911	24	C027	71	C326	27	C857C	73
B911N	24	C028	71	C335	95	C857D	73
B911SR	24	C029	71	C350	77	C860	74
B912	24	C030	71	C3500	77	C861	74
B912N	24	C032	71	C3501	77	C862	74
B912SR	24	C033	71	C3502	77	C865	74
B913	24	C034	71	C3503	77	C880	73
B913N	24	C036	71	C3504	77	C882	73 & 74
B913SR	24	C037	71	C3505	77	C900	72
B914	24	C038	54 & 84	C3506	77	C901	72
B914N	24	C038	54 & 84	C350A	77	C903	76
B915	24	C038L	54 & 84	C350A	77	C903BK	76
B915N	24	C038L	54 & 84	C360	106	C903FP	76
B918	27	C039	54 & 84	C361	106	C904	78
B921BK	26	C039	54 & 84	C361CAP	106	C905	75
B921SR	26	C040	68	C361SOCKET	106	C906	75
B926BK	26	C041	68	C366	107	C907	74

Index by Part Number

Part No.	Page	Part No.	Page	Part No.	Page	Part No.	Page
C908	74	D007NX	42	D333	27	E123	51
C909	74	D008B	42	D334	27	E124	51
C910	72 & 75	D008BS	43	D335	27	E124NBK	51
C910	72 & 75	D008N	42	D337	27	E124NBU	51
C9105	72	D008NS	42	D339	27	E127	51
C9106	72	D008NX	42	D355	94	E129	51
C9108	72	D009N	42	D356	94	E131	52
C911BK	72	D009NS	43	D371	94	E133	52
C911WT	72	D009NX	42	D380	27	E135SP	52
C912	75	D037N	27	D382	27	E139SP	52
C914	78	D039N	27	D602B	43	E150	52
C915	78	D039S	27	D603B	43	E160	76
C916	72	D050N	95	D604N	43	E203	110
C917C8	72	D050N	95	D605B	43	E204	110
C917ST8	72	D101B	42	D605B	43	E205	110
C918/30	72	D102B	42	D605N	43	E206	110
C920	78	D111N	43	D606N	43	E207	111
C922	78	D112N	43	D724	72	E2075	111
C924	78	D112SS	42	D732	72	E210	111
C933	79	D113N	43	D733	72	E225BK	50
C939	106	D207B	40	D742	72	E225BU	50
C941A	106	D207BH	40	D744	72	E225GY	50
C941B	106	D207G	40	D748	72	E225NB	50
C942A	106	D207GH	40	E062	78	E225WT	50
C942B	106	D207N	40	E078	111	E225YE	50
C944A	106	D207NH	40	E080	111	E226BK	50
C950	104	D207R	40	E085BK	93	E226BU	50
C951	104	D207RH	40	E085CR	93	E226GY	50
C952	104	D207W	40	E085II	93	E226NB	50
C953	104	D207WH	40	E085SD	93	E226RD	50
C954	105	D208B	40	E085SW	93	E226WT	50
C955	105	D208G	40	E085WT	93	E227BK	50
C956	105	D208N	40	E088	111	E227BK38	50
C959	105	D208R	40	E090BK	93	E227BU	50
C960N	39	D208W	40	E090BU	93	E227GR	50
C962N	39	D209B	40	E090WT	93	E227GY	50
C980	83	D209BH	40	E095BG	93	E227NB	50
C981	83	D209G	40	E095BI	93	E227RD	50
C989	84	D209GH	40	E095BK	93	E227WT	50
D001N	42	D209N	40	E095BU	93	E228BK	50
D001NX	42	D209NH	40	E095FGR	93	E228NB	50
D002B	42	D209R	40	E095GY	93	E228WT	50
D002N	42	D209RH	40	E095NV	93	E345	36
D002NX	42	D209W	40	E095PG	93	E347	36
D003B	42	D209WH	40	E095RD	93	E351	36
D003BS	43	D210B	40	E095WT	93	E352	36
D003N	42	D210N	40	E097NV	93	E361	37
D003NS	43	D210R	40	E097OY	93	E362	37
D003NX	42	D210W	40	E097SR	93	E363	37
D004B	42	D211B	40	E101	52	E364	37
D004BS	43	D211G	40	E108	51	E392	36
D004N	42	D211N	40	E109	51	E393	36
D004NS	43	D211R	40	E110	51	E394	36
D004NX	42	D211W	40	E111	51	E397	36
D005B	42	D212B	40	E112	51	E401	36
D005BS	43	D212G	40	E113	51	E403	36
D005N	42	D212N	40	E114	51	E432	36
D005NS	43	D212R	40	E115	51	E434	36
D005NX	42	D213B	40	E115BK	52	E435	36
D006B	42	D213G	40	E116	51	E441	36
D006BS	43	D213N	40	E117	51	E443	36
D006N	42	D213R	40	E118	51	E451	36
D006NS	43	D214B	40	E119	51	E452	36
D006NX	42	D214G	40	E120	51	E453	36
D007B	42	D214N	40	E120NRD	51	E454	36
D007BS	43	D214R	40	E121	51	E455	36
D007N	42	D331	27	E121BK	52	E461	36
D007NS	43	D332	27	E122	51	E462L	36

Index by Part Number

Part No.	Page	Part No.	Page	Part No.	Page	Part No.	Page
E463	36	E567NB	62	EB092DWT	66	F0300A00Y	89
E464L	36	E567WT	62	EB092FWT	66	F0300A10Y	89
E491	93	E568BK	62	EB092GWT	66	F0300A14Y	89
E491R	36	E568NB	62	EB092LWT	66	F0300A18Y	89
E492	93	E568WT	62	EF1500CH1T	67	F0300A22Y	89
E492R	36	E569WT	62	EF1500DH1T	67	F0300A44Y	89
E493	93	E570BK	62	EF1500WH1T	67	F0300A46Y	89
E493R	36	E570NB	62	EF2640CH1T	67	F0300A60Y	89
E494	93	E570WT	62	EF2640DH1T	67	F0300A65Y	89
E494R	36	E571BK	62	EF2640WH1T	67	F0300A74Y	89
E500	64	E571NB	62	ET030WT	65	F0300A75Y	89
E500H	64	E571WT	62	ET046BK	65	F0300A90Y	89
E500L	64	E572BK	62	ET046BU	65	F0300A97Y	89
E510	64	E572NB	62	ET046WT	65	F0300A98Y	89
E510H	64	E572WT	62	ET069BK	65	F0400A09Y	89
E510L	64	E574BK	62	ET069BU	65	F0400A10Y	89
E511	64	E574NB	62	ET069GR	65	F0400A17Y	89
E511H	64	E574WT	62	ET069GY	65	F0400A37Y	89
E511L	64	E576BK	62	ET069RD	65	F0400A42Y	89
E512	64	E576NB	62	ET069TN	65	F0400A82Y	89
E512H	64	E576WT	62	ET069WT	65	F0400A96Y	89
E512L	64	E577BK	62	ET092BK	65	F0400A97Y	89
E515	64	E577NB	62	ET092BU	65	F0400A98Y	89
E517	64	E577WT	62	ET092GY8	65	F0800A00Y	90
E520	64	E578BK	62	ET092TN8	65	F0800A10Y	90
E520H	64	E578NB	62	ET092WT	65	F0800A14Y	90
E520L	64	E578WT	62	ET138BK	65	F0800A18Y	90
E521	64	E579WT	63	ET138BU	65	F0800A20Y	90
E521H	64	E580	62	ET138GY	65	F0800A44Y	90
E521L	64	E581	62	ET138TN	65	F0800A46Y	90
E522	64	E583	62	ET138WT	65	F0800A60Y	90
E522H	64	E584	62	ET207WT	65	F0800A65Y	90
E522L	64	E584BK	62	ET346WT	65	F0800A75Y	90
E530	64	E584NB	62	ET353	68	F0800A79Y	90
E530H	64	E585	62	EW346	67	F0800A88Y	90
E530L	64	E585BK	62	EW351	67	F0800A90Y	90
E531	64	E585NB	62	EW352	67	F0800A97Y	90
E531H	64	E586	62	EW462	67	F0805A00Y	91
E531L	64	E586BK	62	EW499	67	F0805A18Y	91
E532	64	E586NB	62	EW500	67	F0805A60Y	91
E532H	64	E587	62	EY092BEG8	66	F0805A88Y	91
E532L	64	E588	62	EY092BG8	66	F0808Z00Y	91
E551	12	E589	62	EY092BK8	66	F0808Z18Y	91
E552	12	E591	63	EY092BRN8	66	F0808Z79Y	91
E552LX300	12	E592	63	EY092CNV8	66	F0808Z88Y	91
E553	12	E593	63	EY092FGR8	66	F0808Z90Y	91
E560BK	62	E594	63	EY092GY8	66	F0808Z97Y	91
E560NB	62	E598WT	62	EY092JRD8	66	F6002X00M	111
E560WT	62	E600WT	62	EY092LN8	66	F7010Z00M	58
E561BK	62	E670HWT	63	EY092LRD8	66	F81500100	87
E561NB	62	E670LWT	63	EY092NV8	66	F81500220	87
E561WT	62	EA069BK	65	EY092PB8	66	F83500100	87
E562BK	62	EA069PB	65	EY092SR8	66	F83500206	87
E562NB	62	EA069WT	65	EY092TS8	66	F83500207	87
E562WT	62	EA092BK	65	EY092WT8	66	F83500210	87
E563BK	62	EA092BU	65	EY138BEG8	66	F83500220	87
E563NB	62	EA092GY	65	EY138BG8	66	F83500230	87
E563WT	62	EA092PB	65	EY138BR8	66	F83500300	87
E564BK	62	EA092WT	65	EY138CNV8	66	F83500400	87
E564NB	62	EA138BK	65	EY138FGR8	66	F83500402	87
E564WT	62	EA138WT	65	EY138GY8	66	F83500450	87
E565BK	62	EB046DWT	66	EY138LN8	66	F83500500	87
E565NB	62	EB046FWT	66	EY138LRD8	66	F83500600	87
E565WT	62	EB046GWT	66	EY138NV8	66	F83500700	87
E566BK	62	EB069DWT	66	EY138PB8	66	F83500800	87
E566NB	62	EB069FWT	66	EY138RD8	66	F83500910	87
E566WT	62	EB069GWT	66	EY138SR8	66	F84500100	87
E567BK	62	EB069LWT	66	EY138TS8	66	F84500206	87

Index by Part Number

Part No.	Page	Part No.	Page	Part No.	Page	Part No.	Page
F84500207	87	FS82008	88	G191WT	108	G676	100
F84500210	87	FS82010	88	G200S	48	G679	100
F84500220	87	FS82012	88	G203S	48	G721S	101
F84500230	87	FS82013	88	G204N	48	G723END	101
F84500300	87	FS82015	88	G210S	47	G730S	97
F84500401	87	FS82016	88	G215S	48	G730S	97
F84500402	87	FS82017	88	G221	48	G731S	97
F84500450	87	G040BK	96	G221S	48	G731S	97
F84500500	87	G040WT	96	G222	48	G742S	48
F84500600	87	G045BK	95	G222S	48	G744S	97
F84500700	87	G045WT	95	G223	48	G747S	97
F84500800	87	G050BK	103	G308	103	G750S	99
F84500910	87	G052BK	103	G309	103	G750SSET/3	99
FH058BK	115	G100	104	G370	103	G751S	99
FH062BK	115	G101	104	G512	94	G751SSET/6	99
FH062WT	115	G103	104	G515WT/24	94	G758	99
FH063WT	116	G104	104	G517WT	94	G760	99
FH160BK	116	G105	104	G520-8	95	G761	99
FH160BU	116	G106	104	G530	94	G770S	97
FH160FO	116	G110	104	G535WT/20	94	G770S	97
FH160RD	116	G113	104	G590	100	G771S	97
FH160WT	116	G115S	104	G590C	100	G771S	97
FH162WTFR	115	G116S	104	G603	100	G820S	98
FH172GY	115	G118	104	G604S	97	G830S	98
FH350GY	89	G119	104	G605S	97	G840S	98
FH350GY	89	G120	104	G607S	96	INS001	55
FH350RB	89	G130	104	G610S	98	INS001BU	55
FH350RB	89	G140	105	G611S	98	INS007B/R	55
FH350WT	89	G140BK	105	G615S	98	INS009BU	55
FH350WT	89	G140BKM	105	G615SQP	98	INS009RD	55
FH352BI	117	G140BKM	105	G620BK	102	INS011RD	55
FH352BK	117	G140BU	105	G620S	98	INS017BU	55
FH352DSD	117	G140NV	105	G621BK	102	INS019	55
FH352GY	117	G140SS	105	G621S	98	INS023BK	55
FH352RB	117	G140TST	105	G622BK	102	INS027B/R	55
FH352WT	117	G140WT	105	G622S	96	INS028BU	55
FH354AL	117	G141	105	G623S	96	INS029BU	55
FH354BK	117	G141SS	105	G624S	97	INS031	55
FH354GR	117	G142	105	G625LAN	96	INS033BK	55
FH354GY	117	G142SS	105	G625PIN	96	INS037RD	55
FH354NV	117	G143	105	G625S	96	INS039BK	55
FH354RB	117	G143SS	105	G625SQP	96	INS041BK	55
FH354WT	117	G145	105	G626S	96	INS045RD	55
FH354YE	117	G145SS	105	G627PIN	96	INS047	55
FH359BK	116	G146	105	G628SQP	96	INS051	55
FH359GY	116	G147	105	G629S	97	INS055	55
FH359NV	116	G149SS	105	G630SHD	98	INS059	55
FH359RB	116	G151	105	G631SHD	98	INS061	55
FH359WT	116	G152	105	G635S	99	INS067BK	55
FH372CG	117	G152OS	105	G638	102	INS071RD	55
FH374BK	118	G160ABK	107	G639	102	INS073BK	55
FH590BK	118	G160AWT	107	G640SHD	98	INS075	55
FH590WT	118	G160BK	107	G641SHD	98	J015BK	53
FH592WT	118	G160WT	107	G650WT	102	J015BU	53
FHKP60WT	114	G161BK	107	G651WT	102	J015GY	53
FP072CL	114	G161WT	107	G652WT	102	J015OR	53
FP072CL	78	G164	108	G653WT	102	J015RD	53
FP072NB	114	G165	108	G655	101	J015WT	53
FP072NB	78	G165TOOL	108	G660	101	J020BK	53
FP072SB	114	G166	108	G661	101	J020BU	53
FP072SB	78	G167	108	G662	101	J020FY	53
FP080CL	114	G168	108	G665	102	J020GR	53
FP080CL	78	G171	105	G666	102	J020GY	53
FS82000	88	G171FW	105	G667	102	J020OR	53
FS82002	88	G172	104	G668	102	J020RD	53
FS82003	88	G173	104	G670	102	J020WT	53
FS82005	88	G175	105	G674	101	J025BK	53
FS82006	88	G190WT	108	G675	100	J025BU	53

Index by Part Number

Part No.	Page	Part No.	Page	Part No.	Page	Part No.	Page
J050GY	53	J610WT	54	M401	80	S80125T	34
J050RD	53	J613WT	54	M402	80	S80150	34
J050WT	53	J614WT	53	M403	80	S80200	34
J060WT	53	J665W	58	M404	80	SC225	56
J073	54	J686W	58	Q020	19	SC230	56
J080	59	J822	111	Q021	19	SC250	56
J080WT	53	J832	111	Q110	18	SC300	56
J082	59	J862	111	Q143	45	SC380	56
J100WT	53	J872	111	Q144	45	SC450	56
J112V	58	J874	111	Q145	45	SL001	57
J117V	58	J959	82	Q146	45	SL225	57
J125WT	53	J959A	82	Q147	45	SL230	57
J132	60	J969	82	Q148	45	SL250	57
J133	60	J970	82	Q149	45	SL300	57
J134	60	J971	82	Q150	45	SL380	57
J150WT	53	K120/10	111	RSESC03WRD	37	SL450	57
J180	60	K221	110	RSESC04WRD	37	SN150	56
J181	60	K305/2	110	RSESC05WRD	37	SN225	56
J182	60	K305/5	110	RSESC06WRD	37	SN230	56
J200WT	53	K310/2	110	RSESC08WRD	37	SN250	56
J250WT	53	K310/5	110	S40025	34	SN300	56
J310	59	K310/5SM	110	S40040	34	SN380	56
J311	59	K315/2	110	S40045	34	SN450	56
J312	59	K315/2LSM	110	S40050	34	T025GR	35
J313	59	K432	111	S40060	34	T025RD	35
J314	59	K631	110	S40063	34	T025WT	35
J315	59	K903	78	S40070	34	T040GR	35
J411	58	L150	32	S40075	34	T040RD	35
J412	58	L152	32	S40080	34	T040WT	35
J413	58	L401	32	S40100	34	T050GR	35
J414	58	L402	32	S50040	34	T050RD	35
J415	58	L403	32	S50050	34	T050WT	35
J416	58	L441	32	S50060	34	T060GR	35
J417	58	L442	32	S50063	34	T060RD	35
J419	58	L443	32	S50070	34	T060WT	35
J451	59	L575	94	S50075	34	T075GR	35
J452	59	L575T	94	S50080	34	T075RD	35
J453	59	L585	94	S50090	34	T075WT	35
J455	59	LR001025	33	S50100	34	T080GR	35
J456	59	LS001	93	S50125	34	T080RD	35
J472	59	LS001	93	S50350	34	T080WT	35
J514BK	53	LS002	93	S60040	34	T39025BK	35
J514BU	53	LS401BK	112	S60050	34	T39025BU	35
J514FP	53	LS401BU	112	S60060	34	T39025GR	35
J514FY	53	LS401GY	112	S60063	34	T39025RD	35
J514GR	53	LS401TN	112	S60070	34	T39040BU	35
J514GY	53	LU600	33	S60075	34	T39040GR	35
J514KE	53	M003	80	S60080	34	T39040RD	35
J514NB	53	M004	80	S60090	34	T39050BK	35
J514OR	53	M005	80	S60100	34	T39050BU	35
J514RD	53	M010	82	S60120	34	T39050GR	35
J514SL	53	M012	82	S60125	34	T39050RD	35
J514WT	53	M013	82	S60150	34	T39075BK	35
J514YE	53	M016	82	S70060	34	T39075BU	35
J530WT	53	M020	81	S70063	34	T39075GR	35
J530WTUV	53	M030	63	S70070	34	T39075RD	35
J550BK	53	M031	63	S70075	34	V006BK	112
J550RD	53	M032	63	S70080	34	V006BR	112
J550WT	53	M040	81	S70090	34	V006BU	112
J601BK	54	M040	81	S70100	34	V006DG	112
J601BU	54	M150	80	S70120	34	V006GR	112
J601GD	54	M151	80	S70125	34	V006GY	112
J601GR	54	M212	81	S70150	34	V006NB	112
J601HP	54	M216	80	S70175	34	V006RD	112
J601LB	54	M2214	81	S80060	34	V006WT	112
J601PU	54	M2224	81	S80075	34	V006YE	112
J601RD	54	M301	70	S80080T	34	ZMARKERWT	79
J601SR	54	M305	70	S80100	34	ZPENCILBU	79
J601WT	54	M321	70	S80100T	34	ZPENCILWT	79
J602	54	M322	70	S80125	34		

Index by Product Name

303	Fabric Cleaner	81	Soft Nose			Fittings	96 - 102	
	Fabric Guard	82	Aquabattens	30mm	9	Hooks	95	
	Ultra-Violet Protection 82		Stiff			Cutting Equipment	74 - 75	
3M	Adhesive Spray - Super	82	Aquabattens	30mm	9	Pads	77	
Tape		58		40mm	9	Punches	77	
A								
Acrylic	Binding Tape	93	Tensioners		13	D		
	Cover Fabrics	86 - 92	Vinylester Battens		10 - 11	D Rings	45, 46	
	Seaming Tape	58	Top Aquabattens	10mm	6	Dabond Thread	65	
Solacryl		86 - 87		15mm	7	Dinghy Battens	6 - 7	
	Sunbrella®	88	Yacht Aquabattens	15mm	8	Headboards	23	
Adhesive	Remover	54		30mm	9	Dodger Hanks	96	
	Spray	80	Beeswax	40mm	9	DOT Fasteners	104 - 105	
	Tapes	58 - 60	Bench Press	End Caps	8 - 9	Double Sided Tape	58 - 61	
	Vinyl	80	Binding Tape		68	Draft Stripe	53	
Adjuster Buckles		47 - 48	Blocks	Mainsail Outhaul	22	E		
Allslip slides		16		Offshore Reef	22	Edging Tapes	35	
Anti-Wick Thread		66	Boat Cover	Fabrics	86 - 92	Elastic	12	
Aquabattens		4 - 9		Fittings	96 - 102	Endcaps	5 - 9, 11	
Aquabatten Pro		4 - 5	Boat Snap Hooks		46	End Fittings	13	
Awls		72	Boat Top	Fabrics	86 - 92	Engel Hot Knives	74	
Awning	Fabrics	86 - 92		Fittings	96 - 102	English Grommets	42	
	Poles	103	Bobbins		66	External Track Slides	118	
	Tapes	93 - 94	Bolt Rope		36	Extra Stiff Aquabattens	9	
	Track	94	Bridges		49	Eyelets	Brass 42 - 43	
B								
Bag	General Purpose	84	Buckles	Cam	47		Nickel 42 - 43	
	Cloth	149		Ladderlock	47		Socket Setter 106	
	Cord	112 - 113		Snap	48	Eyes	95	
	Sailcloth	121 - 122		Adjuster	47	F		
Battens	Aquabattens	4 - 9	Button Snap Fasteners	Sliding Bar	48	Fabric	Boat Cover 86 - 92	
	Aquabatten Pro	Battens 4 - 5			105		Cleaners 81	
		End Caps 5	C					Mesh 115 - 117
	Batten Pocket Elastic	12	Cam Buckles		74	Window	110 - 111	
	Batten Pocket Protectors		Canopy Fittings		96 - 103	Fasteners	Button Snap 105	
		Dinghy Sails 12	Centre Fold Tapes		93		Commonsense™ 104	
		Catamaran Sails 12	Chalk		79		Lift-the-Dot® 104	
		Cruising Sails 12	Clamcleats		28 - 30		Permalock 107	
	Contract Battens	10 - 11	Clamps	Cloth	79		Tenax 108	
	Dinghy Batten	10mm 6		Shockcord	38		Velcro® 64	
		15mm 7	Class Insignia		55		Zip 62 - 63	
	End Fittings		Cleaners	303 Fabric	81	Firesist	88	
		Flat Battens 13	Cleats	Mildew	81	Fiskars Scissors	75	
		Round Battens 13	Clew		28 - 31	Flat Battens	10	
Battens	Extra Stiff Aquabattens		Boards		28	Flex-A-Rail	94	
		30mm 9	Pieces		44		Screws 94	
		40mm 9	Rings		45		Square Head Screwdriver 95	
	Flat Battens	10	Closing Tools	Grommets	42 - 43	G		
	Jib Battens	10mm 8		Headboard Liners	27	Grommets	42 - 43	
		15mm 88		Inox Rings	41		Closing Tools 42 - 43	
	Leech Aquabattens	10mm 6		Semi-Tubular Rviets	27		Hole Punches 77	
		15mm 7	Cloth Clamps		79	H		
		End Caps 6 - 7	Clothing		120	Hammers	76	
	Lofting Battens	78	Coil Zip		62 - 63	Hand Punch	77	
	Round Battens	11	Coloured Sailcloth Tape		35	Hand Sewing Thread	67 - 68	
	Sailman Battens	11	Coloured Webbing		50	Wax	68	
	Screw Compression Fitting	13	Commonsense™ Fasteners		104	D		
	SDA Full Batten Fittings	14 - 15	Cone Hooks		38	D Rings	45, 46	
	Slides	16 - 18	Copper Sleeves		39	Dabond Thread	65	
			Cover	Eyes	95	Dinghy Battens	6 - 7	
				Fabrics	86 - 92	Headboards	23	
				Fasteners	104 - 107	Dodger Hanks	96	

Index by Product Name

Headboards	Dinghy	23		Sewing Machine Oil	70	Pressed Rings	40 - 41
	Yacht	24 - 26	Luff	Foam	33	Presses	41
	Liners	27		Line	36	Press-N-Snap Tool	106
Headsail Tape		32 - 33		Rope	36	Protectants	303 Fabric Guard 82
Hemmingway & Bartlett Thread		65		Tape	32 - 33		Mildew Remover 81
Hole Punches		77	M				Seam Kote 80
Holiday Cover Fabrics		90	Mainsail Luff Tape		32	Protectors	Batten Pocket 12
Hook & Loop		64	Mainsail Reefing Systems		13 - 15		Jib Hank 21
Hooks	Boat Snap	47	Marker		79		Shackle 19 - 20
	Cover	95	Marking	Out Chalk	79	Punches	Hole 77
	Shockcord	37		Pencils	79		Lift-the-Dot Fasteners 104
	Snap Hooks	46	Mauls		76		Permalock 107
	Wichard	21	Maxi Rings		44		Snap Fasteners 106
Hot Knives		73 - 74	McLube - Sailkote		80		Commonsense Fasteners 104
Hot Tool		74	Measuring Tapes		79	Push Pins	76
			Mesh Fabrics		115 - 117		
I			Mildew Cleaner		81	R	
Inox Ring System		40 - 41	Monofilm		111	Reef Blocks	22
Insignia	Class	55	Mooring Poles	103		Repair	Kits 83 - 84
	Dacron	54	Mosquito Netting		115		Tapes 54
	Polyester	53	Mylar® Pattern Material		78	Rings	D Rings 45 - 46
	Tapes	53 - 54	N				Inox Pressed 40 - 41
J			Nautimar Marine Cover Fabric		92		Welded Stainless Steel 44 - 46
Jack Stay Webbing		52	Natuipus Marine Cover Fabric		92	RIPair®	Nylon Tape 54
Jib	Battens	8	Needles		71		Tape Boxes 54
	Hank Protectors	21	Netting, Mosquito		115	Rippers, Seam	75
	Hanks	21	Nicopress Sleeves		39	Rivets	27
			Numbers	Cloth	53	Rope	Bag Cord 36
				Pre-Cut	56		Boltrope 36
			Nylon	Bag Cloth	112 - 114		Leechline 36
				RIPair® Tape	54		Luffline 36
				Sailcloth Tape	34 - 35		Piping Cord 93
K			O				
Kevlar®	Patch Cloth	58	Odyssey Cover Fabrics		91	Round	Battens 11
	Webbing	52	Outhaul	Attachments	22		Rings 44 - 46
Kneepads		78		Blocks	22	S	
Knit Mesh		116	P			Sail	Grommets 42 - 43
L			Pads	Cutting	77		Insignia 53
Lacing Buttons		95		Knee	78		Letters 56
Ladderlock Buckles		47	Palms		71		Numbers 57
Lanyards		96	Patch Cloth		58		Repair Kits 83 - 84
Leather		76	Pattern Material		78		Rings 42 - 45
Leech	Aquabattens	6 - 7	Pencils		78	Sailcloth	Tape 34 - 35
	Cleats	28 - 31	Permalock Fasteners		107		Bags 121
	Line	36	Piping Cord		137		Jackets 120
Leno Mesh		114	Piston Hanks		21		Washbags 122
Letters	Cloth	53	Pliers for Clamps		38	Sailmaker's	Leather 76
	Pre-Cut	56 - 57	Pocket Protectors		12		Needles 71
Lift-the-Dot® Fasteners		104 - 105	Polyester	Cover Fabrics	89 - 92		Palms 71
Liners	Headboard	27		Insignia Cloth	53	Scissors	74 - 75
	Inox Ring	40 - 41		Leechline	36		Tuner 75
The Loft	Sailcloth Jackets	120		Knit Mesh	114	SDA Full Battens Fittings	14 - 15
	Sailcloth Bags	121		Ropes	36	SeaMark Cover Fabric	89
	Sailcloth Washbags	122		Sailcloth Tape	34 - 35	Seam	Kote 80
	Sailcloth Tote Bag	122		Spinnaker Snuffer Material	112		Rippers 75
Lofting Battens		78		Webbing	51 - 52		Roller 61
Loop Loc		49	Polypropylene			Seam Bonding Tape	59 - 61
Lubricant	Teflon	70		Ropes	36	Seaming Tape	58
	Thread	70		Webbing	50	Selden Slides	17
	Sailkote - McLube	80					

Index by Product Name

Sewing	Machine Oil	70	T		
	Needles	71	Tack Hooks & Shackles	20	W
	Palms	71	Teflon®	75	Wax
	Thread	68 - 68	Coated Shears	80	Waxed Thread
Shackles	Sail Shackles	19 - 20	Lubricating Spray	34	Webbing
	Snap Shackles	19	Tape	93	Jack Stay
	Protectors	20	Binding	34	Kevlar
Shears	Sharpeners	74 - 75	Edging	34	Polyester
		75	Folded	34	Polypropylene
Shockcord	Clamps	37	Insignia	53	Spectra
	Cord Lock	37	Measures	79	Tubular
	Cover Clips	96	RIPair®	54	Attachments
	Hooks	38	Sailcloth	34 - 35	Bridges
	Webbing Connector	38	Seaming	58	Welded Rings
Sister Clips		96	Spinnaker	35	Whipping Twine
Sleeveknit Mesh		116	3M	58	Wichard Jib Hanks
Sleeves		39	Tenax Fasteners	108	Tack Hooks
Slides	Allslip	116	Textilene Mesh Fabrics	117	William Smith
	External	118	Thimbles	39	Palms
	Flat	116	Thread	65 - 68	Repair Kit
	Internal	116 - 118	Anti-Wick	66	Sail Needles
	Outhaul	41	Hand	67 - 68	Window Material
	SDA	15	Lubricants	70	Wiss Shears
	Selden	76	Lubricators	70	
	Slug	17	Machine	70	Y
	Track	16 - 18	Machine Oil	70	Yacht
Sliding Bar Buckles		48	Snips	75	Aquabattens
Slit Tape		34	Waxed	68	Headboards
Slug Slides		17	Tools	70 - 84	YKK Zip
Snap	Buckles	47	Button Snap	105	
	Fasteners	105	Commonsense™	104	Z
	Hooks	49	Grommet	42 - 43	Zip
	Shackles	19	Headboard Liner	27	
Snips, Thread		75	Inox	41	
Soft Nose Aquabattens		9	Lift-The-Dot	104	
Solacryl		86 - 97	Permalock	107	
Spectra	Webbing	52	Press-N-Snap	106	
Spinnaker	Edging Tape	34	Rivet	27	
	RIPair Tape	54	Tenax	108	
	Snuffer Material	112 - 114	Top Gun Cover Fabric	89	
Spray	Adhesive 3M	32	Track	100	
	Lubricant	80	Slides	100 - 101	
Stainless Steel			Trampoline Mesh	118	
	Boat Top Fittings	96 - 98	Transformer	74	
	Hanks	21	Triangles, Stainless Steel	44	
	Hooks	21	Tubular Webbing	51	
	Liners	27	Twine - Whipping	68	
	Rings	42 - 45	Tylaska Tack Hook	20	
	Sail Rings	42 - 45	U		
	Snap Shackles	19	Universal Deck Hinges	97	
	Shackles	19 - 20	UV Protectors 303 Fabric Guard	82	
	Slides	17	303 Ultra-Violet Protection	82	
	Thimbles	39	SPF-uv™	111	
	Triangles	44	V		
	Welded Hardware	44 - 46	Velcro®	64	
Staples		72	Vinyl	82	
Staple Removers		72	Adhesive	82	
Stiff Aquabattens		9	Binding Tape	93	
Stimpson Grommets		43	Cutting Pads	77	
Sun Protective Film		111	Coated Solacryl	86 - 87	
Sunbrella®		88	Cover Fabrics	86 - 92	
SUN SOX		112	Luff Rope	36	
SUNSURE® Mesh		116	Mesh	116 - 117	
Super Lube		80	Vinylester Battens	10 - 11	
Super Luff		32	Vislon Zip	62	
Super Tramp Mesh Fabric		118			

Terms & Conditions

Standard Terms & Conditions of Sales

1. CONTRACTS

- a. Contracts are made and orders accepted only upon and subject to these Terms and Conditions of Sale. All other conditions are hereby excluded unless expressly accepted in writing by the Bainbridge International Ltd (hereinafter called the "Seller").
- b. In entering into a contract with the Seller, the contracting party (hereinafter called the "Buyer") acknowledges that the contract has not been induced by any representations orally or in writing made by the Seller, its servants or agents.
- c. Any quotation, estimate or tender previously given or made by the Seller was not an offer but an intimation of the terms upon which the Seller was prepared to negotiate. The offer to contract with the Buyer made by these conditions may be accepted by the Buyer in a formal manner or may be inferred from the Buyer's acceptance of performance, in whole or in part, by the Seller. Any conditions contained in any purported acceptance by the Buyer shall be disregarded and the acceptance shall be construed as an unconditional acceptance of these conditions.
- d. Any typographical, clerical or other error or omission in any sales literature, quotation, price list, acceptance of offer, invoice or other document or information issued by the Seller shall be subject to correction without any liability on the part of the Seller.

2. PRICES

- a. Unless expressly stated otherwise by the Sellers, all prices quoted are ex works and exclude the cost of packing. Any applicable value added tax or any other sales tax or excise duties paid or payable by the Seller shall be added to the price and shall be payable by the Buyer. The Seller may, at their sole absolute discretion, accept or reject any order placed by the Buyer. The Seller may change the price of goods for future invoiced goods to the Buyer without notice.
- b. In the event of the Buyer cancelling a part of the order in accordance with the provisions of Clause 12, the Seller reserves the right to revise the price or prices quoted for goods already delivered.
- d. The contract price is, unless specifically agreed upon in writing by the Seller, payable in Pound Sterling. The Seller reserves the right to review the contract price(s) in the event of devaluation of the Pound Sterling or substantial change in the value of Pound Sterling in the foreign exchange markets.

3. CONDITIONS AND WARRANTIES

- a. Seller shall not be liable for the normal manufacturing defects nor any customary variations from quantities or specifications. A variance of not more than 15% either way from the total specified weight, quantity or length shall be deemed compliance with this contract.
- b. Where samples of goods or a colour chart are provided, these are submitted only as indicative of the class, size or colour of goods quoted for and sales of goods shall not be by reference to any such samples or colour charts.
- c. Whilst all description and illustrations of the goods in (inter alia) catalogues, brochures, web sites and price lists provided by the Seller have been carefully prepared, they are intended nevertheless for general guidance only and do not form part of any contract for sale of goods and no responsibility is accepted for any errors or omissions therein or for any loss or damage resulting from reliance on such descriptions and illustrations.
- d. When the Seller agrees to provide a specially designed plan, the Buyer agrees that he is obliged to check the accuracy and suitability of the plan and that the Seller shall not be liable for any omissions or inaccuracies in the measurements given. The copyright in the plan drawn up by the Seller is, and remains, their property and may not be reproduced in whole or in part without written consent.
- e. If the Buyer claims or detects a defect in the goods, the Buyer will seek prior approval and return those goods to the Seller or, if the goods are rejected by the Buyer, indemnify and keep the Seller indemnified against all liability and claims which may arise out of or incidental to the defect.
- f. The Seller has undertaken no responsibility for learning about the end purpose or use for which the goods are to be used, and the Buyer shall undertake to conduct whatever tests or examinations are necessary to confirm that goods are suitable for such end use.
- g. Any typographic products that may be sold hereunder are sold subject to any imperfections that are typically regarded as acceptable in the textile trade resulting from the weaving and finishing thereof, and Seller shall have no liability in connection with any such imperfections. Buyer warrants that all merchandise covered by this contract is purchased for resale as tangible personal property, or to be incorporated as a component or part of other tangible property to be produced for sale by manufacturing, assembling or processing.
- h. The Buyer shall not be entitled to accept part only of the goods.

4. DELIVERY BY THE SELLER

- a. Unless and except as otherwise expressly provided in writing by the Seller, delivery shall be F.O.B., Seller's usual place of business.
- b. Any dates quoted for delivery of the goods are approximate only and the Seller shall not be liable for any delay in delivery of the goods whatsoever caused. Time for delivery shall not be of the essence unless previously agreed by the Seller in writing.
- c. Where goods are offered for delivery to a site, the Seller's obligation is to deliver as near to the site as safe hard roads permit. The Buyer is to provide at its own expense the labour required for unloading and stacking.
- d. The Seller reserves the right to deliver goods by instalments and in such event each instalment shall be treated as a separate contract save that the delivery of further instalments may be withheld until goods contained in earlier instalments have been paid for in full.
- e. Where goods are held by the Seller awaiting delivery instructions, they may be subject to a storage charge. For account holding customers, payment for these goods must be made on or before the last day of the month following the month of the invoice; for non-account holding customers, payment must be made at the time of ordering.
- f. In the absence of shipping instructions, the issuing of an invoice shall constitute delivery to the Buyer.

5. COLLECTION BY THE BUYER

- a. Where goods are sold "ex-factory" the Buyer shall collect the goods at the Seller's premises within seven days of the Seller's notifying the buyers that the goods are ready for collection.
- b. If the Buyer fails to collect the goods within seven days of notification that they are ready for collection, then, without prejudice to any other right or remedy available to the Seller, the Seller may:
 - i. Store the goods until actual delivery and charge the Buyer for reasonable costs (including insurance) of storage; or
 - ii. Sell the goods at the best price readily obtainable (after deducting all reasonable storage and selling expenses) account to the Buyer for the excess over the price under the contract or charge the Buyer for any shortfall below the price.

6. DAMAGE, LOSS, SHORT DELIVERY

- a. On delivery, the Buyer shall examine the goods for defects and completeness. Thereafter no claim for damage in transit, for shortage in delivery, or for loss of goods will be entertained except, in the case of damage, a separate notice in writing is given to the Carriers or to the Seller within three days of the receipt of the goods, followed within 14 days of the date of advice of despatch by a complete claim in writing; or, in the case of loss of goods, a separate notice in writing and a claim is given to the Seller and Carriers within 14 days of the date of the Seller's advice of despatch to the Buyer. In all cases a signature "unexamined" shall be deemed to be an unconditional acceptance of the goods.
- b. The Seller shall not in any circumstances be liable, whether in contract or tort, to the Buyer for any indirect or consequential loss or damage (including without limitation, loss of profits, loss of contracts or damage to property) or for any claim against the Buyer by any third party.
- c. The Seller's liability for damage or non-delivery of goods duly notified in accordance with the above shall in any event be limited to replacement of the goods within a reasonable time (or, at the Seller's option, refunding the price thereof) whether the damage or non-delivery is due to the Seller's negligence or otherwise.

7. ROLL LENGTHS

- a. Where goods are sold as a measured length there may be a variation in length of plus or minus 2%. In the event of a claim the seller reserves the right to insist that the roll be returned for measuring before a settlement is agreed.

8. CREDIT AGREEMENTS

- a. Where the Sellers has granted the Buyer a credit facility, the price of goods and/or service shall be paid by the Buyer as per the payment terms specified on the invoice or, if the Seller shall so require under Clause (b) of this Clause 7, to be paid on demand without any period of notice.
- b. The Seller reserves the right to withdraw or vary credit facilities at any time to the Buyer without either giving any reason for doing so, or thereby incurring any liability to the Buyer.
- c. If the Buyer takes goods from the Seller in excess of the Buyer's credit limit, the Seller may require payment on delivery for such excess of goods.

9. TERMS OF PAYMENT

- a. Unless credit facilities have been granted to the Buyer or unless otherwise specifically provided in writing, the price for the goods shall be paid by the Buyer in cash on delivery and in default the Seller shall be entitled to withhold delivery until payment. In the case of non-cash sales, the Seller shall be entitled to charge and recover interest from the Buyer on the price of the goods calculated at whichever shall be the greater: the statutory interest payable under the Late Payment of Commercial Debts (Interest) Act 1998 or the rate of 4% per annum over the base lending rate charged by HSBC Bank plc from time to time from the due date until date in full payment.

- b. Unless otherwise expressly agreed upon in writing, no other discounts or commissions are to become due or allowable to the Buyer (any previous course of dealing between the parties notwithstanding).
- c. Where there is a term of contract that payment of any of the Seller's invoices is dependant upon the issues of the certificate of a third party, the due date for payment of the invoice is not later than 14 days after the issue of the relevant certificate.

10. LATE PAYMENT

- a. When payment of any of the Seller's invoices is overdue, the Seller may suspend their performance of the contracts to which the invoice relates and/or of any other contract then subsisting between the Seller and the Buyer.
- b. In the event of legal action being taken by the Seller against the Buyer for breach of payment obligations hereunder, the Buyer shall be responsible for all costs and disbursements incurred by the Seller on a full indemnity basis.

11. RISK AND LIABILITY

- a. Risk of damage to or loss of the goods shall pass to the Buyer at the time of delivery or, if the Buyer at the time of delivery of the goods, the time when the Seller has tendered delivery of the goods. For the purpose of this Clause 10, "delivery" shall mean the arrival of the goods at the place of delivery of the Buyer where delivery is by the Seller, or the safe loading of the goods into the Buyer's vehicles at the Seller's premises where delivery is through collection by the Buyer.
- b. In no event shall the Seller be liable for damages with respect to the sale or use of any product sold hereunder in any amount greater than the amount of the purchase price received by the Seller for that particular product. In addition, the Seller shall not be liable for any consequential, incidental, or special damages or costs or expenses in the event of any breach of warranty or in the event of any loss, damage, injury or cost resulting from, or arising out of, or in respect of the goods being sold hereunder.
- c. When any goods are sold hereunder bear a particular label, trademark, or trade name, affixed at the request of the Buyer, it is the understanding of the parties that the Buyer warrants that he has the right to use said label trademark or trade name, and that he hereby agrees to indemnify and hold harmless the Seller against any loss, damage or claim by any person with respect thereto.
- d. The Buyer agrees to reimburse the Seller, and hold Seller harmless against liability for all expenses, including legal fees, incurred by the Seller that may arise in connection with Seller's enforcement of its rights under this contract.
- e. The Seller has undertaken no responsibility for learning about the end purpose for which the goods are to be used, and Buyer shall undertake to conduct whatever tests or examinations are necessary to confirm that goods are suitable for such end use.

12. RETENTION OF TITLE

- a. Notwithstanding delivery and the passing of risk in the goods or any other provision of these conditions, the property in the goods shall not pass to the Buyer until the Seller has received in cash (or cleared funds) payment in full of the price of the goods and all other goods agreed to be sold by the Seller to the Buyer for which payment is then due.
- b. Until such time as the property in the goods passes to the Buyer, the Buyer shall hold the goods as the Seller's fiduciary agent and bailee, and shall keep the goods separate from those of the Buyer and third parties and properly stored, protected and insured and identified as the Seller's property. Until that time the Buyer shall be entitled to resell or use the goods in the ordinary course of its business, but shall account to the Seller for the proceeds of the sale or otherwise of the goods, whether tangible or intangible, including insurance proceeds, and shall keep all such proceeds separate from any monies or property of the Buyer and third parties and, in the case of tangible proceeds, properly stored, protected and insured.
- c. Until such time as the property in the goods passes to the Buyer (and provided the goods are still in existence and have not been resold), the Seller shall be entitled at any time to require the Buyer to deliver up the goods to the Seller and, if the Buyer fails to do so forthwith, to enter upon any premises of the Buyer or any third party where the goods are stored and repossess the goods.
- d. The Buyer shall not be entitled to pledge or in any way charge by way of security for any indebtedness any of the goods which remain the property of the Seller, but if the Buyer does so, all monies owing by the Buyer to the Seller shall (without prejudice to any other right or remedy of the Seller) forthwith become due and payable.

13. CUSTOMER CANCELLATION OF ORDERS

- a. Contracts and orders and parts thereof may be cancelled only by the Seller's written acceptance of such cancellation. Where the Seller accepts such cancellation, the Seller reserves the right to charge the Buyer with the amount of any losses or expenses directly or indirectly resulting from such cancellation. Where the Seller does not accept such cancellation, the Seller, reserves the right to recover the invoice price from the Buyer and to charge the Buyer with additional losses both direct and indirect resulting from such cancellation. In any case where the Seller were required to place a deposit with a manufacturer or supplier in respect of an order, the Seller may require the Buyer to reimburse such sum in the event of cancellation.

14. CUSTOMERS RETURNING GOODS

- a. The seller will only accept goods being returned by customers if prior consent has been given by the seller. In the event of wishing to return goods customers must contact the seller to obtain a 'goods return note number' that must then be attached in an appropriate manner to the goods. The seller reserves the right to refuse to accept goods being returned by a buyer. In cases where the seller does agree to accept a return the seller reserves the right to charge a 15% handling fee based on the invoice price of the goods.
- b. Excluding circumstances where goods are being returned for the reason of damage or are subject to warrantee claim, goods being returned to the seller must arrive in a condition that allows them to be re-sold. In the event that returned goods are not in good condition the seller reserves the right to withdraw any agreement for credit with the buyer or to charge a handling fee.

15. CONSENTS

- a. The obtaining of any necessary consents for the installation of the goods, whether from local or other authorities or for ensuring that the installation of the goods is in accordance with the provisions of any by-laws, regulations or statutes shall not be the responsibility of the Seller.

16. FORCE MAJEURE

- a. The Seller shall not be liable to the Buyer or be deemed to be in breach of contract by reason of any delay in performing, or any failure to perform, any of the Seller's obligations in relation to the goods, if the delay or failure was due to any cause beyond the Seller's reasonable control. Without prejudice to the generality of the foregoing, the following shall be regarded as causes beyond the Seller's control:

- a. Act of God, explosion, flood, tempest, fire or accident;
- b. War or threat of war, sabotage, insurrection, civil disturbance or requisition;
- c. Acts, restrictions, regulations, by-laws, prohibitions or measures of any kind on the part of any governmental, parliamentary or local authority;
- d. Import or export regulations or embargoes;
- e. Strikes, lock-outs or other industrial actions or trade disputes (whether involving employees of the Seller's or of a third party);
- f. Difficulties in obtaining raw materials, labour, fuel, parts or machinery;
- g. Power failure or breakdown in machinery.

17. INSOLVENCY

- a. The Seller shall have the right to terminate the contract forthwith where the buyer becomes insolvent or bankrupt or makes arrangements with its creditors or suffers a receiver to be appointed or being a body corporate enters into liquidation (other than in connection with a reconstruction or amalgamation) in any of which cases the Seller shall have no further obligation hereunder and the price for all goods delivered and work done shall become immediately due and payable.

18. LAW APPLICABLE

- a. These conditions shall be governed and construed in accordance with English law and all disputes arising in connection therewith shall be submitted to the jurisdiction of the English courts.

19. GENERAL

- a. No provision hereof shall be deemed waived and no breach or default excused unless such waiver or excuse is in writing signed by an authorised officer of the party making the writing.
- b. If any provision or part of a provision of this Agreement shall be, or found by any authority or court of competent jurisdiction to be, invalid or unenforceable, such invalidity or unenforceability shall not affect the other provisions or parts of such provisions of this Agreement, all of which shall remain in full force and effect.
- c. The headings in this document are inserted for convenience only and shall not constitute a part of or be referred to in its interpretation.

© Bainbridge International Limited 2013. Bainbridge® is a registered trademark of Bainbridge International Limited.

Bainbridge International Ltd.

8 Flanders Park
Hedge End
Southampton
Hampshire
SO30 2FZ
England

Tel: +44 (0)1489 776010
Fax: +44 (0)1489 776015

email: info@bainbridgeint.co.uk

Bainbridge International Inc.

255 Revere Street
Canton
Massachusetts
02021
USA

Tel: +1 781 821 2600
Fax: +1 781 821 2609

email: info@bainbridgeint.com

Bainbridge International Inc.

15242 Transistor Lane
Huntington Beach
California
92649-1142
USA

Tel: +1 714 373 3322
Fax: +1 714 373 3326

email: info@bainbridgeint.com

Q.C.D Limited
8 Taylors Road
Sandringham
Auckland 1025
New Zealand

Tel: +64 (0) 9 366 7118
Fax: +64 (0) 9 366 7119

email: sales@qcd.co.nz

Bainbridge International Pty. Ltd.

273 Harbord Road
PO Box 254
Brookvale
NSW 2100
Australia

Tel: +61 (0)2 9938 1788
Toll Free: +61 18 0073 1149
Fax: +61 (0)2 9938 2459

email: info@bainbridgeint.com.au

Bainbridge International France

UniSails SARL
5 rue Marius Berliet
PA de la Biliais Deniaud
44360 Vigneux de Bretagne
France / Spain

Tel: +33 (0)2 51 13 05 40
Fax: +33 (0)2 51 13 04 56

email: info@bainbridgeint.fr

BB Technics Oy
Sinikalliontie 18 B
FIN-02630 Espoo
Finland

Tel: +358 103 098 560
Fax: +358 103 098 565

email: stefan.kevin@bangbonsomer.fi

On Deck BV

Leimuiderdijk 478a
2156 MX Weteringbrug
Holland

Tel: +31 (0)71 3313366
Fax: +31 (0)71 3313387

email: allhands@on-deck.nl

Fordewind-Regatta Ltd

Petrovskaya Kosa 7
197110 St. Petersburg
Russia

Tel: +7 812 327 4580
Fax: +7 812 327 4581

email: alexey.rusetsky@fordewind.spb.ru

Columbus Marine A/S

Svejsegangen 3
Karlslunde
Denmark

Tel: +45 4619 1166
Fax: +45 4619 1353

email: columbus@columbus-marine.dk

Takis Kokkotas Co. Ltd.

80 Mezonos Str
104 38 Athens

Greece / Bulgaria / Romania

Tel: +30 210 52 28 540
+30 210 52 25 897
Fax: +30 210 5247225

email: info@kokkotas.gr

Asperö Handels AB

PO Box 5009
Traneredsvägen 112
SE-426 05 V. Frölunda
Sweden / Norway
Tel: +46 31 299 190
Fax: +46 31 691 965

email: info@aspero.se

Herman Gotthardt GmbH

Leunastrasse 50
D-22761 Hamburg
Germany

Tel: +49 40 85150550
Fax: +49 40 8509133

email: info@gotthardt-yacht.de

Boat Rigging s.r.l.

Via San Gallo 23
Tavernelle Val di Pesa Loc. Sambuca (FI)
Italy

Tel: +39 055 8071964
Fax: +39 055 8091541

email: luca@boatrigging.it

Sacloma S.a.s

Via Cisa Sud 125
19037 S.Stefano di Magra (SP)
Italy

Tel: +39 0187 630603
Fax: +39 0187 633264

email: sacloma@sacloma.com



www.bainbridgeint.com

Technical Innovation and Service - The Fabric of Our Business